

Price List

Leader in Water Tempering Technology Since 1891

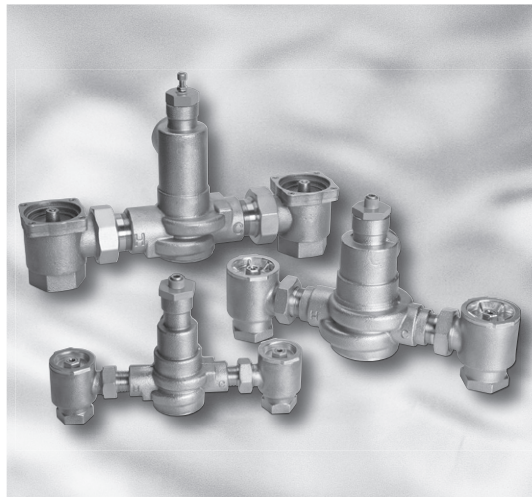

Effective October 8, 2018

All prices supersede previous issues, are temporary and subject to change without notice.

Electronic is Green!

For the latest Powers pricing information in electronic format, visit our Data Exchange at:

www.wattswater.com/dataexchange

- Download product and list price data in .pdf
- Easy access to list price data for business systems
- Sign up for e-mail alerts when data is updated
- Access other Watts Water Technologies brands pricing data

A WATTS Brand

Standard Terms and Conditions of Sale	2-3	Accessories	
Pressure Balancing Valves		High Temperature Shutoff Device	34
Series 900 Biltmore®	4	Checkstops	34
Series PB410 HydroGuard®	6-7	Showerheads	34
PressureGuard®	6	Institutional Showerheads	34
Combination T/P Bath, Shower and Lavatory Valves		Arm/Flange Kits	35
HydroGuard® T/P Series e700	5	Hand Showers	35
VisuGuard® Series F727 and C727	8	Tub Spouts	36
HydroGuard® T/P Series e423 Valves	9	Diverter	36
HydroGuard® T/P Series e420	9-10	Vacuum Breakers	36
HydroGuard® T/P Series e427/e428	11	Volume Control Valves	36
Thermostatic Lavatory Valves		Dial Thermometers	36
TempTap™ Faucet	12	Metering Valve Shower	36
HydroGuard® Series LFe480	13	Self Operating Regulators	
HydroGuard® Series LFLM490/LFLM490-10	13	#11 Complete Regulators	37
HydroGuard® Series LFLM495	14	#11 Lower Housing Assemblies	37
Thermostatic Master Mixing Valves		#11 Thermal Systems and Accessories	38
HydroGuard® XP Series LFMM430 & Supply Fixtures	15-16	Flowrite® Valves and Accessories	
HydroGuard® XP Series LFSH1430 & Supply Fixtures	17	Heavy Duty Bronze Series Flowrite® Valves and Accessories	39-40
The Lead Free Tempering Re-circulation Loop	18	Heavy Duty Iron Series Flowrite® Valves and Accessories	41-42
HydroGuard® XP Series LFMM430 & LFSH1430 HiLo Supply Fixtures	19	Flowrite II Unmounted Valve Accessories	43
HydroGuard® XP High Capacity Systems Series LFSH1430	20	Accritem® Controllers and Accessories	44
IntelliStation®		Parts	45-64
Single & Multi-Valve Lead Free	21		
IntelliStation® Jr.			
Single & Multi-Valve Lead Free	22		
POWERSTATION™			
Single-Valve Lead Free	23		
Multi-Valve Lead Free	24		
Emergency Tempering Valves,			
HydroGuard® ES/ETV Series	25-26		
Hydropanel II Modular Systems			
With e700 Valves	27		
With 900, PB410 and e420 Valves	28-29		
HydroGuard® ESP™			
Showers	30		
Shower Systems (Hydropanel II ESP)	31		
Alarm Systems			
Lead Free Aqua Sentry® 2 Series LF460	32		
Thermostatic Specialty Valves			
Fotoguard	33		
Fotopanel	33		

Freight Terms: All prices are FOB factory. Full freight is allowed on shipments of \$1,500 or more within the continental U.S.A. Such allowance is based on the lowest motor carrier transportation rate. Terms for export shipment will be provided on request.

Terms of Sale: All sales are F.O.B. shipping point.

Payment Terms: Invoices are due and payable 30 days from the date of invoice.

Purchase Order Forms: Orders submitted on the Purchaser's own purchase order forms will be accepted only with the express understanding that no statements, clauses or conditions contained in said order form will be binding on the Seller if they in any way modify the Seller's own terms and conditions of sales.

Minimum Order Requirements: Minimum order requirements are \$100 net.

Special Products: Orders for special or modified products are non-cancelable. In the event that the customer cancels an order for such products, Watts shall charge the customer an amount equal to Watts' costs and expenses incurred in performing the purchase order prior to receipt of notice of cancellation.

Partial Shipment: The Seller reserves the right to make partial shipments from time to time and render invoices therefor which shall be due and payable in accordance with stated payment terms.

Delays: The Seller shall not be liable for any loss, damage, or delay occasioned by any causes beyond the Seller's control, including, but not limited to governmental actions or orders, embargoes, strikes, differences with workmen, fires, floods, accidents, or transportation delays.

Rejection of Shipments: If the Purchaser is unable or unwilling to accept any shipment, the Purchaser shall be liable to the Seller, in addition to any other rights to which the Seller may be entitled, for freight, express, storage, extra cost of handling, and other expenses incurred thereby.

Taxes: The amount of any present or future sales, use, occupancy, excise, or other tax, federal, state or local, which the Seller now, or hereafter shall be legally obligated to pay, either on its own behalf or on behalf of the Purchaser or otherwise, with respect to the material covered by this order or contract, shall (unless the prices contained herein are stated expressly to include such tax) be added to such prices and paid by the Purchaser. Purchaser agrees to report and pay any tax direct on non-exempt transaction, in case Seller's invoices do not indicate a charge therefor.

Limited Warranty: The Seller warrants each HydroGuard T/P e700 series valve to be free from defects in material and workmanship under normal usage for a period of one year from the date of original shipment. The Seller further warrants the internal tempering mechanism to be free from defects in material and workmanship under normal usage for a period of five years from the date of original shipment. The Seller warrants all other equipment manufactured by it to be free from defects in material and workmanship under normal usage for a period of one year from the date of original shipment. In the event of such defects within the applicable warranty period, the Seller will, at its option, repair or replace the product without charge.

The remedy described in the paragraph above shall constitute the sole and exclusive remedy for breach of warranty, and the Seller shall not be responsible for any incidental, special or consequential damages, including without limitation, lost profits or the cost of repairing or replacing other property which is damaged if the product does not work properly, damages or other costs resulting from labor charges, delays, vandalism, negligence, fouling caused by foreign material, damage from adverse water conditions, chemicals, decomposition by galvanic action, or any other circumstances over which the Seller has no control. This warranty shall be invalidated by any abuse, misuse, misapplication or improper installation of this product.

THE WARRANTY SET FORTH HEREIN IS GIVEN EXPRESSLY AND IS THE ONLY WARRANTY GIVEN BY THE SELLER WITH RESPECT TO THE PRODUCTS. THE SELLER MAKES NO OTHER WARRANTIES, EXPRESS OR IMPLIED. THE SELLER SPECIFICALLY DISCLAIMS ALL OTHER WARRANTIES, EXPRESS OR IMPLIED, INCLUDING BUT NOT LIMITED TO THE IMPLIED WARRANTIES OF MERCHANTABILITY AND FITNESS FOR A PARTICULAR PURPOSE.

Some states do not allow limitations on how long an implied warranty lasts, and some states do not allow the exclusion or limitation of incidental or consequential damages. Therefore the above limitations may not apply to you. This Limited Warranty gives you specific legal rights, and you may have other rights that vary from state to state. You should consult applicable laws to determine your rights. **SO FAR AS IS CONSISTENT WITH APPLICABLE STATE LAW, ANY IMPLIED WARRANTIES THAT MAY NOT BE DISCLAIMED, INCLUDING THE IMPLIED WARRANTIES OF MERCHANTABILITY AND FITNESS FOR A PARTICULAR PURPOSE, ARE LIMITED IN DURATION TO ONE YEAR FROM THE DATE OF ORIGINAL SHIPMENT.**

Purchaser's Remedies: IN NO EVENT SHALL THE SELLER BE LIABLE, IN CONTRACT, TORT, STRICT LIABILITY, OR UNDER ANY OTHER LEGAL THEORY, FOR INCIDENTAL, INDIRECT, SPECIAL OR CONSEQUENTIAL DAMAGES, REGARDLESS OF WHETHER IT WAS INFORMED OF THE POSSIBILITY OF SUCH DAMAGES, AND IN NO EVENT SHALL THE SELLER'S LIABILITY EXCEED AN AMOUNT EQUAL TO THE SALES PRICE OF THE PRODUCTS. THE FOREGOING LIMITATIONS SHALL APPLY TO THE FULLEST EXTENT PERMITTED BY LAW.

Shortage Claims: Claims for shortage or incorrect filling of orders must be made within 15 days from the date of delivery.

Return Goods Policy: No material shall be returned without authorization. When credit is issued it will be at the price charged, or prevailing price if lower, less handling charges based on costs of reconditioning, boxing, etc. However, a minimum 25% handling charge will apply. A minimum handling charge of \$20.00 is applied whenever the 25% handling deduction does not total \$20.00. Products which are obsolete or made to special order are not returnable.

Returned Material Procedure: Customer Service will provide a Return Material Authorization (RMA) number, which must be written on all shipping label(s) of the returned material. Material received without an RMA number may be refused and returned to the sender at the sender's expense. When calling or faxing to request an RMA number, the following information will be necessary:

- Seller invoice number and/or sales order number
- Seller part number
- Seller product description
- Quantity of material to be returned
- Reason for return—be specific
- All returns must be shipped freight prepaid

All returned material is subject to inspection by the Seller and should be returned in original unopened shipping cartons or suitably packed to prevent damage in transit.

Customer Support:

For Customer Service: (978) 689-6066; Monday through Friday, 8:00 AM to 5:00 PM EST. Fax number (978) 975-8350.

For Technical Support: (800) 669-5430; Monday through Friday, 8:00 AM to 5:00 PM CST. Fax number (847) 229-0526.

Note: Prices and terms are subject to change without notice and supersede all previous quotations. The Seller reserves the right to change or modify product design or construction without prior notice and without incurring any obligation to make such changes and modifications on products previously or subsequently sold. Weights are not guaranteed but are shown only for the Purchaser's reference.

Governing Law: These terms and conditions shall be governed by, construed, and enforced in accordance with the laws of the Commonwealth of Massachusetts, without giving effect to its choice of law rules. All disputes under these terms and conditions shall be resolved exclusively by courts located in the Commonwealth of Massachusetts.







Special order and non-standard material is non-cancelable and not returnable.

ALL MTO PRODUCTS ARE NON-RETURNABLE

A **WATTS Brand**

All Series 900 Pressure Balancing Mixing Valves include integral check/service stops, adjustable handle rotation limit stop, reversible inlets for back-to-back installation, four-port connections, and reliable poppet/diaphragm cartridge construction.



	Description	Order Code	Weight	List Price
P902 	SS faceplate, metal lever handle. CP finish.			
	 1/2" copper sweat connections 1/2" IPS connections	P902H P902G	3.2 3.2	\$308.00 \$314.00
P905 	ABS faceplate with color-coded graphics, lever handle. CP finish.			
	 1/2" copper sweat connections 1/2" IPS connections	P905H P905G	3.0 3.0	\$227.00 \$231.00
P909 	ABS faceplate with color-coded graphics, acrylic handle. CP finish.			
	1/2" copper sweat connections 1/2" IPS connections	P909H P909G	3.0 3.0	\$282.00 \$289.00
P910 	ABS faceplate with color-coded graphics, metal lever handle. CP finish.			
	 1/2" copper sweat connections 1/2" IPS connections	P910H P910G	3.0 3.0	\$292.00 \$301.00

To order complete Series 900 systems:

Valves

See above for selection of valve order code _____

	List Price	Weight (lbs)	Order Code
Showerheads, Arm and flange			
Economizer, Chrome-Plated ABS, Arm & Flange	\$51.00	0.8	J1
Standard Chrome-Plated Brass, Arm & Flange	\$73.00	1.2	K1
Deluxe, Chrome Plated Brass, Arm and Flange	\$99.00	1.6	M1
Low Flow Shower (1.5 gpm), Arm & Flange	\$137.00	2.8	G1
Low Flow Shower (1.5 gpm), Arm & Flange	\$115.00	0.53	H1
Arm & Flange Only (no showerhead)	\$31.00	0.3	O1
Economizer, Arm & Flange & Hi-Temp Shut-Off	\$120.00	1.1	J4
Standard Arm & Flange & Hi-Temp Shut-Off	\$142.00	1.5	K4
Deluxe Arm & Flange & Hi-Temp Shut-Off	\$168.00	1.9	M4
Low Flow Shower (1.5 gpm), Arm & Flange & Hi-Temp Shut-Off	\$206.00	3.1	G4
Low Flow Shower (1.5 gpm), Arm & Flange & Hi-Temp Shut-Off	\$184.00	1.1	H4
Tub Spouts			
Non-Diverter, Chrome Plated 1/2" IPS	\$45.00	0.4	R
Diverter, Chrome Plated 1/2" IPS	\$54.00	0.7	S
Diverter, Chrome Plated 1/2" Slip-Fit	\$59.00	1.0	U
Hand Shower Systems			
24" Chrome ADA Wall Grab Bar System	\$442.00	4.7	1
36" Chrome ADA Wall Grab Bar System	\$455.00	5.5	2
Deluxe, Metal Hose, 30" Glide Rail	\$517.00	3.5	3
Professional, Vinyl Hose, 30" Glide Rail	\$432.00	2.7	4
Standard, Metal Hose, Two Wall Hooks	\$205.00	2.0	5
Deluxe, Metal Hose, 24" Glide Rail	\$432.00	3.1	6
Professional, Vinyl Hose, 24" Glide Rail	\$276.00	2.3	7
Standard Plus, Metal Hose, 24" Glide Rail	\$268.00	3.0	8
European, Metal Hose, 23" Glide Rail	NLA	2.0	9
Low Flow (1.5 gpm), Metal Hose, 30" Glide Rail	\$475.00	5.0	L
Professional, Metal Hose, 30" Glide Rail	\$361.00	2.8	N
Low Flow (1.5 gpm) Metal Hose, Two Wall Hooks	\$284.00	4.8	K
Miscellaneous Accessories			
Vacuum Breaker, Elevated, Chrome-Plated	\$312.00	2.0	V
Vacuum Breaker, in-Line	\$48.00	1.0	W
Diverter, Concealed, 1/2" IPS Metal Handle	\$222.00	3.0	Y
Diverter, Concealed, Deluxe ABS Handle	\$237.00	3.0	A
Diverter, Concealed, Deluxe Metal Handle	\$244.00	3.0	B
Diverter, Exposed, Showerhead Type	\$71.00	0.5	Z

A WATTS Brand

All e700 Series valves feature advanced thermal actuators, adjustable handle rotation limit stop, integral checkstops, metal or ABS trim and 1/2" sweat connections. The e700 Series meets American with Disabilities Act (ADA) requirements.

5-year Limited Warranty.



e705

e707

e710

	List Price	Weight (lbs)	Order Code
Valves			
ABS Trim	\$362.00	3.5	e705
Metal Trim	\$387.00	3.5	e710
Euro Trim	\$419.00	3.5	e707
Showerheads			
Economizer, Chrome-Plated ABS, Adjustable	\$20.00	0.5	J
Standard, Chrome-Plated Brass	\$42.00	0.9	K
Deluxe, Chrome-Plated Brass	\$68.00	1.3	M
Low Flow (1.5 gpm), Chrome-Plated	\$106.00	2.5	G
Low Flow (1.5 gpm), Chrome-Plated	\$84.00	0.5	H
Arm and Flange Kits			
Standard Arm and Flange	\$31.00	0.3	1
Deluxe Arm and Flange	\$48.00	0.4	2
Standard Arm/Flange & Hi-Temp. Shut-Off	\$100.00	0.6	4
Deluxe Arm/Flange & Hi-Temp. Shut-Off	\$118.00	0.7	5
Tub Spouts			
Diverter, Chrome-Plated Brass, 3/4" IPS	\$101.00	1.2	Q
Non-Diverter, Chrome-Plated, 1/2" IPS	\$45.00	0.4	R
Diverter, Chrome-Plated, 1/2" IPS	\$54.00	0.7	S
Diverter, Chrome-Plated Brass, 1/2" IPS	\$93.00	1.3	T
Diverter, Chrome-Plated, 1/2" Slip-fit	\$59.00	1.0	U
Hand Shower Systems			
24" Chrome ADA Wall Grab Bar System	\$442.00	4.7	1
36" Chrome ADA Wall Grab Bar System	\$455.00	5.5	2
Deluxe, Metal Hose, 30" Glide Rail	\$517.00	3.5	3
Professional, Vinyl Hose, 30" Glide Rail	\$432.00	2.7	4
Standard, Metal Hose, Two Wall Hooks	\$205.00	2.0	5
Deluxe, Metal Hose, 24" Glide Rail	\$432.00	3.1	6
Professional, Vinyl Hose, 24" Glide Rail	\$276.00	2.3	7
Standard Plus, Metal Hose, 24" Glide Rail	\$268.00	3.0	8
European, Metal Hose, 23" Glide Rail	NLA	2.0	9
Low Flow (1.5 gpm), Metal Hose, 30" Glide Rail	\$475.00	2.8	L
Professional, Metal Hose, 30" Glide Rail	\$361.00	2.8	N
Low Flow (1.5 gmp) Metal Hose, Two Wall Hooks	\$284.00	4.8	K
Diverters			
Concealed Diverting Valve, 1/2" IPS, Metal Handle	\$222.00	3.0	Y
Diverter, Concealed, Deluxe ABS Handle	\$237.00	3.0	A
Diverter, Concealed, Deluxe Metal Handle	\$244.00	3.0	B
Exposed Diverter, Shower Arm-Type, Chrome-Plated	\$71.00	0.5	Z
Vacuum Breakers			
Vacuum Breaker, Elevated, Chrome-Plated	\$312.00	2.0	V
Vacuum Breaker, In-Line	\$48.00	1.0	W

	Order Code	Weight	List Price
Biltmore™ Series 900 Accessories/Parts			
Thin Wall Installation	900 119	0.3	\$30.00
Remodeling Plate, Stainless Steel, Polished Chrome	900121D	1.0	\$56.60
Vandal-Resistant Screw Kit*	900 034	0.11	\$26.200

*Parts discount applies

A **WATTS** Brand

Series PB410 HydroGuard® Pressure Balancing Valves

The series PB410 HydroGuard® features heavy, cast brass construction, a poppet type equalizing valve which offers a distinct advantage: it will not stick because of lime build-up or foreign particles in the supplies. The adjustable metal-to-metal temperature limit stop prevents accidental scalding caused by our adjustment of the handle. It also features integral checkstops, back to back and shallow installation. PB410 series is listed to ASSE 1016-P and certified to CSA B125 standard.



Model PB413000000

	Order Code	Weight	List Price
3 Port	PB413	4.0	\$586.00
4 Port	PB417	4.6	\$586.00

	Order Code	Weight	List Price
Series PB410 Accessories/Parts			
Thin Wall Installation Accessory	800 100	0.3	\$30.00
Stem Extension Accessory*	410 233	0.3	\$28.10
Vandal-Resistant Screw Kit*	420 267	0.3	\$9.70
Remodeling Plate, Stainless Steel. Polished Chrome	900121D	1.0	\$56.60

**Parts discount applies*

PressureGuard™



For controlling inlet pressures to two-handle valves and mechanical mixing valves used in showers, sinks, and baths

4100063	3.0	\$450.00
----------------	-----	----------

To order complete Series PB410 systems...

Port	List Price	Weight (lbs)	Order Code
3 Port	\$586.00	4.0	PB413
4 Port	\$586.00	4.6	PB417
Showerheads			
Economizer, Chrome-Plated ABS, Adjustable	\$20.00	0.5	J
Standard, Chrome-Plated Brass	\$42.00	0.9	K
Deluxe, Chrome-Plated Brass	\$68.00	1.3	M
Low Flow (1.5 gpm) (Chrome-Plated)	\$106.00	2.5	G
Low Flow (1.5 gpm) (Chrome-Plated)	\$84.00	0.5	H
Arm and Flange Kits			
Standard Arm and Flange	\$31.00	0.3	1
Deluxe Arm and Flange	\$48.00	0.4	2
Standard Arm/Flange & High Temp. Shut-Off	\$100.00	0.6	4
Deluxe Arm/Flange & High Temp. Shut-Off	\$118.00	0.7	5
Tub Spouts			
Diverter, Chrome-Plated Brass, 3/4" IPS	\$101.00	1.2	Q
Non-Diverter, Chrome-Plated, 1/2" IPS	\$45.00	0.4	R
Diverter, Chrome-Plated, 1/2" IPS	\$54.00	0.7	S
Diverter, Chrome-Plated Brass, 1/2" IPS	\$93.00	1.3	T
Diverter, Chrome-Plated, 1/2" Slip-fit	\$59.00	1.0	U
Hand Shower Systems			
24" Chrome ADA Wall Grab Bar System	\$442.00	4.7	1
36" Chrome ADA Wall Grab Bar System	\$455.00	5.5	2
Deluxe, Metal Hose, 30" Slide Bar	\$517.00	3.5	3
Professional, Vinyl Hose, 30" Glide Rail	\$432.00	2.7	4
Standard, Metal Hose, Two Wall Hooks	\$205.00	2.0	5
Deluxe, Metal Hose, 24" Glide Rail	\$432.00	3.1	6
Professional, Vinyl Hose, 24" Glide Rail	\$276.00	2.3	7
Standard Plus, Metal Hose, 24" Glide Rail	\$268.00	3.0	8
European, Metal Hose, 23" Glide Rail	NLA	2.0	9
Low Flow (1.5 gpm), Metal Hose, 30" Glide Rail	\$475.00	5.0	L
Professional, Metal Hose, 30" Glide Rail	\$361.00	2.8	N
Low Flow (1.5 gpm), Metal Hose, Two Wall Hooks	\$284.00	4.8	K
Diverters			
Concealed Diverting Valve, 1/2" IPS, Metal Handle	\$222.00	3.0	Y
Diverter, Concealed, Deluxe ABS Handle	\$237.00	3.0	A
Diverter, Concealed, Deluxe Metal Handle	\$244.00	3.0	B
Exposed Diverter, Shower Arm-Type, Chrome-Plated	\$71.00	0.5	Z
Vacuum Breakers			
Vacuum Breaker, Elevated, Chrome-Plated	\$312.00	2.0	V
Vacuum Breaker, in-Line	\$48.00	1.0	W



A **WATTS** Brand

VisuGuard LCD features advanced thermal actuator, battery operated LCD temperature readout. Battery enclosure is easily accessible and watertight. ASSE 1016 T/P and cUPC listed.



	List Price	Weight (lbs)	Order Code	7	2	7					
Temperature Display (factory set)											
Celsius	\$801.00	4.8	C								
Fahrenheit	\$801.00	4.8	F								
Showerheads											
Economizer, Chrome-Plated ABS, Adjustable	\$20.00	0.5	J								
Standard, Chrome-Plated Brass	\$42.00	0.9	K								
Deluxe, Chrome-Plated Brass	\$68.00	1.3	M								
Low Flow (1.5 gpm), Chrome-Plated	\$106.00	2.5	G								
Low Flow (1.5 gpm), Chrome-Plated	\$84.00	0.5	H								
Arm & Flange Kits											
Standard Arm & Flange	\$31.00	0.3	1								
Deluxe Arm & Flange	\$48.00	0.4	2								
Standard Arm/Flange & High Temp. Shut-Off	\$100.00	0.6	4								
Deluxe Arm/Flange & High Temp. Shut-Off	\$118.00	0.7	5								
Tub Spout											
Diverter, Chrome-Plated Brass, 3/4" IPS	\$101.00	1.2	Q								
Non-Diverter, Chrome-Plated, 1/2" IPS	\$45.00	0.4	R								
Diverter, Chrome-Plated Brass, 1/2" IPS	\$54.00	0.7	S								
Diverter, Chrome-Plated Brass, 1/2" IPS	\$93.00	1.3	T								
Diverter, Chrome-Plated, 1/2" Slip-fit	\$59.00	1.0	U								
Hand Shower System											
24" Chrome ADA Wall Grab Bar System	\$442.00	4.7	1								
36" Chrome ADA Wall Grab Bar System	\$455.00	5.5	2								
Deluxe, Metal Hose, 30" Glide Rail	\$517.00	3.5	3								
Professional, Vinyl Hose, 30" Glide Rail	\$432.00	2.7	4								
Standard, Metal Hose, 2 Wall Hooks	\$205.00	2.0	5								
Standard, Metal Hose, 24" Glide Rail	\$432.00	3.1	6								
Professional, Vinyl Hose, 24" Glide Rail	\$276.00	2.3	7								
Standard Plus, Metal Hose, 24" Glide Rail	\$268.00	3.0	8								
European, Metal Hose, 23" Glide Rail	NLA	2.0	9								
Low Flow (1.5 gpm), Metal Hose, 30" Glide Rail	\$475.00	5.0	L								
Professional, Metal Hose, 30" Glide Rail	\$361.00	2.8	N								
Low Flow (1.5 gpm), Metal Hose, Rwo Wall Hooks	\$284.00	4.8	K								
Diverters											
Diverter, Concealed, 1/2" IPS, Metal Handle	\$222.00	3.0	Y								
Diverter, Concealed, 1/2" IPS, Deluxe ABS Handle	\$237.00	3.0	A								
Diverter, Concealed, 1/2" IPS, Deluxe Metal Handle	\$244.00	3.0	B								
Exposed Diverter, Shower Arm-Type	\$71.00	0.5	Z								
Vacuum Breakers											
Vacuum Breaker, Elevated, Chrome-Plated	\$312.00	2.0	V								
Vacuum Breaker, In-Line	\$48.00	1.0	W								

A WATTS Brand

HydroGuard® T/P Series e420 Valves

All HydroGuard T/P® shower valves feature advanced thermal actuator compensate for both temperature and pressure fluctuations. A built-in adjustable metal-to-metal temperature limit stop reduces chance of accidental scalding due to the over adjustment of handle. Heavy cast brass body, integral checkstop, durable brass faceplate, lever-type handles, and corrosion-resistant material provide years of trouble-free service. ASSE 1016 T/P listed and CSA B125 certified.



4 Ports concealed valves, 1/2" NPT inlets/outlets

	Order Code	Weight	List Price
Color coded trim plate, Dome handle	e420T12	5.5	\$779.00
Etched trim plate, Dome handle	e420T22	5.5	\$779.00

4 Ports concealed valves, 1/2" Sweat inlets/outlets

	Order Code	Weight	List Price
Color coded trim plate, Dome handle	e420S12	5.5	\$779.00
Etched trim plate, Dome handle	e420S22	5.5	\$779.00

Series e423 Thermostatic Valve

HydroGuard Series e423 Valves

Exposed thermostatic water mixing valve features advance thermal actuator, adjustable limit stop, polished chrome-plated lever handle and mounting bracket. ASSE 1016, CSA



Model e423320



Valve	List Price	Weight	Order Code
e42332	\$870.00	5.3	e423
Checkstops (Sold in Pairs)			
Straight, 1/2" IPS, Polished Chrome	\$257.00	1.0	B
Angled with Strainer, 1/2" IPS, Polished Chrome	\$367.00	2.4	F
Factory installation of checkstops (add suffix "X" to checkstop code) Min. order 10	\$54.00	---	X

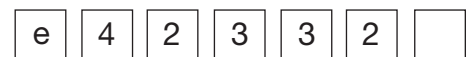

A WATTS Brand

	List Price	Weight (lbs)	Order Code	e420
Connections				
1/2" NPT Inlets/Outlets	\$779.00	5.0	T	<input type="checkbox"/>
1/2" Sweat Inlets/Outlets	\$779.00	5.0	S	<input type="checkbox"/>
Trim Plate				
Color Coded	N/C	—	1	<input type="checkbox"/>
Etched	N/C	—	2	<input type="checkbox"/>
Handle				
Dome	N/C	—	2	<input type="checkbox"/>
Showerheads				
Economizer, Chrome-Plated ABS, Adjustable	\$20.00	0.5	J	<input type="checkbox"/>
Standard, Chrome-Plated Brass	\$42.00	0.9	K	<input type="checkbox"/>
Deluxe, Chrome-Plated Brass	\$68.00	1.3	M	<input type="checkbox"/>
Low Flow (1.5 gpm), Chrome-Plated	\$106.00	2.5	G	<input type="checkbox"/>
Low Flow (1.5 gpm), Chrome-Plated	\$84.00	0.5	H	<input type="checkbox"/>
Arm & Flange Kits				
Standard Arm & Flange	\$31.00	0.3	1	<input type="checkbox"/>
Deluxe Arm & Flange	\$48.00	0.4	2	<input type="checkbox"/>
Standard Arm/Flange & High Temp. Shut-Off	\$100.00	0.6	4	<input type="checkbox"/>
Deluxe Arm/Flange & High Temp. Shut-Off	\$118.00	0.7	5	<input type="checkbox"/>
Tub Spouts				
Diverter, Chrome-Plated Brass, 3/4" IPS	\$101.00	1.2	Q	<input type="checkbox"/>
Non-Diverter, Chrome-Plated, 1/2" IPS	\$45.00	0.4	R	<input type="checkbox"/>
Diverter, Chrome-Plated, 1/2" IPS	\$54.00	0.7	S	<input type="checkbox"/>
Diverter, Chrome-Plated Brass, 1/2" IPS	\$93.00	1.3	T	<input type="checkbox"/>
Diverter, Chrome-Plated, 1/2" Slip-fit	\$59.00	1.0	U	<input type="checkbox"/>
Hand Shower Systems				
24" Chrome ADA Wall Grab Bar System	\$442.00	4.7	1	<input type="checkbox"/>
36" Chrome ADA Wall Grab Bar System	\$455.00	5.5	2	<input type="checkbox"/>
Deluxe, Metal Hose, 30" Glide Rail	\$517.00	3.5	3	<input type="checkbox"/>
Professional, Vinyl Hose, 30" Glide Rail	\$432.00	2.7	4	<input type="checkbox"/>
Standard, Metal Hose, Two Wall Hooks	\$205.00	2.0	5	<input type="checkbox"/>
Deluxe, Metal Hose, 24" Glide Rail	\$432.00	3.1	6	<input type="checkbox"/>
Professional, Vinyl Hose, 24" Glide Rail	\$276.00	2.3	7	<input type="checkbox"/>
Standard Plus, Metal Hose, 24" Glide Rail	\$268.00	3.0	8	<input type="checkbox"/>
European, Metal Hose, 23" Glide Rail	NLA	2.0	9	<input type="checkbox"/>
Low Flow (1.6 gpm), Metal Hose, 30" Glide Rail	\$475.00	5.0	L	<input type="checkbox"/>
Professional, Metal Hose, 30" Glide Rail	\$361.00	2.8	N	<input type="checkbox"/>
Low Flow (1.5 gpm), Metal Hose, Two Wall Hooks	\$284.00	4.8	K	<input type="checkbox"/>
Diverters				
Concealed Diverting Valve, 1/2" IPS, Metal Handle	\$222.00	3.0	Y	<input type="checkbox"/>
Diverter, Concealed, Deluxe ABS Handle	\$237.00	3.0	A	<input type="checkbox"/>
Diverter, Concealed, Deluxe Metal Handle	\$244.00	3.0	B	<input type="checkbox"/>
Exposed Diverter, Shower Arm-Type, Chrome-Plated	\$71.00	0.5	Z	<input type="checkbox"/>
Vacuum Breakers				
Vacuum Breaker, Elevated, Chrome-Plated	\$312.00	2.0	V	<input type="checkbox"/>
Vacuum Breaker, In-Line	\$48.00	1.0	W	<input type="checkbox"/>

A WATTS Brand

e427/e428 HydroGuard® Shower valves features advanced thermal actuator, adjustable handle rotation limit stop, stainless steel dial plate with concealed mounting screws, and color coded temperature graphics. ASSE 1016 listed CSA certified.



Model e427

Model e428



Valves	List Price	Weight (lbs)	Order Code
Concealed	\$998.00	5.8	e427*
Exposed Chrome-Plated	\$998.00	5.7	e428*
Checkstops (Sold in Pairs)			
Concealed Straight, 1/2" IPS	\$87.00	1.1	A
Straight, 1/2" Sweat	\$87.00	1.1	C
Angled, 1/2" Sweat	NLA	1.3	D
Angled, with Strainer, 1/2" IPS	\$235.00	2.5	E
Exposed Straight, 1/2" IPS, Chrome-Plated	\$257.00	1.0	B
Angled, with Strainer, 1/2" IPS, Chrome-Plated	\$367.00	2.4	F
Factory installation of checkstops (Add suffix "X" to checkstop code) Min. order 10	\$54.00	—	X
Showerheads			
Economizer, Chrome-Plated ABS, Adjustable	\$20.00	0.5	J
Standard, Chrome-Plated Brass	\$42.00	0.9	K
Deluxe, Chrome-Plated Brass	\$68.00	1.3	M
Low Flow (1.5 gpm), Chrome-Plated	\$106.00	2.5	G
Low Flow (1.5 gpm), Chrome-Plated	\$84.00	0.5	H
Arm and Flange Kits			
Standard Arm and Flange	\$31.00	0.3	1
Deluxe Arm and Flange	\$48.00	0.4	2
Standard Arm/Flange & High Temp. Shut-Off	\$100.00	0.6	4
Deluxe Arm/Flange & High Temp. Shut-Off	\$118.00	0.7	5
Tub Spouts			
Diverter, Chrome-Plated Brass, 3/4" IPS	\$101.00	1.2	Q
Non-Diverter, Chrome-Plated, 1/2" IPS	\$45.00	0.4	R
Diverter, Chrome-Plated, 1/2" IPS	\$54.00	0.7	S
Diverter, Chrome-Plated Brass, 1/2" IPS	\$93.00	1.3	T
Diverter, Chrome-Plated, 1/2" Slip-fit	\$59.00	1.0	U
Hand Shower Systems			
24" Chrome ADA Wall Grab Bar System	\$442.00	4.7	1
36" Chrome ADA Wall Grab Bar System	\$455.00	5.5	2
Deluxe, Metal Hose, 30" Glide Rail	\$517.00	3.5	3
Professional, Vinyl Hose, 30" Glide Rail	\$432.00	2.7	4
Standard, Metal Hose, Two Wall Hooks	\$205.00	2.0	5
Deluxe, Metal Hose, 24" Glide Rail	\$432.00	3.1	6
Professional, Vinyl Hose, 24" Glide Rail	\$276.00	2.3	7
Standard Plus, Metal Hose, 24" Glide Rail	\$268.00	3.0	8
European, Metal Hose, 23" Glide Rail	NLA	2.0	9
Low Flow (1.5 gpm), Metal Hose, 32" Glide Rail	\$475.00	5.0	L
Professional, Metal Hose, 30" Glide Rail	\$361.00	2.8	N
Low Flow (1.5 gpm), Metal Hose, Two Wall Hooks	\$284.00	4.8	K
Diverter			
Concealed Diverter Valve, 1/2" IPS, Metal Handle	\$222.00	3.0	Y
Diverter, Concealed, Deluxe ABS Handle	\$237.00	3.0	A
Diverter, Concealed, Deluxe Metal Handle	\$244.00	3.0	B
Exposed Diverter, Shower Arm-Type, Chrome-Plated	\$71.00	0.5	Z
Vacuum Breakers			
Vacuum Breaker, Elevated, Chrome-Plated	\$312.00	2.0	V
Vacuum Breaker, In-Line	\$48.00	1.0	W

*For Shower or Bath only application. Not suitable for Combination Bath & Shower application

TempTAP™ thermostatic faucets feature solid brass construction and an advanced thermal actuator to provide the latest in thermal protection. TempTAP™ faucets automatically mix hot and cold water and deliver pre-set water within a specific range. TempTAP™ thermostatic faucets are listed to ASSE 1070, IAPMO cUPC and certified to NSF/ANSI 61 Section 9 Annex G. They also meet the activation requirements of ADA.



Description	List Price	Weight (lbs)	Order Code
Lavatory Faucet & 2.0 gpm Aerator	\$447.00	3.5	105
Lavatory Faucet & 2.0 gpm Vandal Resistant Aerator	\$463.00	3.5	105VA
Lavatory Faucet, 6" Lever Handle & 2.0 Aerator	\$464.00	3.7	105-6
Lavatory Faucet, 2.0 gpm Aerator & Pop-Up Waste	\$489.00	3.8	105PW
Lavatory Faucet & 0.5 gpm Outlet	\$455.00	3.5	105A5
Lavatory Faucet & 0.5 gpm Vandal Resistant Outlet	\$465.00	3.5	105V5
Lavatory Faucet & 1.5 gpm Aerator+	\$455.00	3.5	105A15
Lavatory Faucet & 2.0 gpm Laminar flow outlet	\$463.00	3.5	105L
Lavatory Faucet & 2.0 gpm Vandal Resistant Laminar flow outlet	\$465.00	3.5	105VL
Lavatory Faucet & 0.5 gpm Laminar flow outlet	\$478.00	3.5	105L5
Lavatory Faucet & 0.5 gpm Vandal Resistant Laminar flow outlet	\$488.00	3.5	105VL5
Lavatory Faucet, Deck Plate & 2.0 gpm Aerator	\$479.00	4.1	115
Lavatory Faucet, Deck Plate & 2.0 gpm Vandal Resistant Aerator	\$498.00	4.1	115VA
Lavatory Faucet, Deck Plate, 6" Lever Handle & 2.0 Aerator	\$499.00	4.3	115-6
Lavatory Faucet, Deck Plate, 2.0 gpm Aerator & Pop-Up Waste	\$521.00	4.4	115PW
Lavatory Faucet, Deck Plate & 0.5 gpm Outlet	\$490.00	4.1	115A5
Lavatory Faucet, Deck Plate & 0.5 gpm Vandal Resistant Outlet	\$500.00	4.1	115V5
Lavatory Faucet, Deck Plate & 1.5 gpm Aerator+	\$490.00	4.1	115A15
Lavatory Faucet, Deck Plate & 2.0 gpm Laminar flow outlet	\$498.00	4.1	115L
Lavatory Faucet, Deck Plate & 2.0 gpm Vandal Resistant Laminar flow outlet	\$500.00	4.1	115VL
Lavatory Faucet, Deck Plate & 0.5 gpm Laminar flow outlet	\$512.00	4.1	115L5
Lavatory Faucet, Deck Plate & 0.5 gpm Vandal Resistant Laminar flow outlet	\$520.00	4.1	115VL5
Gooseneck Spout & 2.0 gpm Aerator	\$584.00	4.7	205
Gooseneck Spout & 2.0 gpm Vandal Resistant Aerator	\$600.00	4.7	205VA
Gooseneck Spout, 6" Lever Handle & 2.0 Aerator	\$601.00	4.9	205-6
Gooseneck Spout & 0.5 gpm Outlet	\$590.00	4.7	205A5
Gooseneck Spout & 0.5 gpm Vandal Resistant Outlet	\$603.00	4.7	205V5
Gooseneck Spout & 1.5 gpm Aerator+	\$590.00	4.7	205A15
Gooseneck Spout & 2.0 gpm Laminar flow outlet	\$600.00	4.7	205L
Gooseneck Spout & 2.0 gpm Vandal Resistant Laminar flow outlet	\$603.00	4.7	205VL
Gooseneck Spout & 0.5 gpm Laminar flow outlet	\$614.00	4.7	205L5
Gooseneck Spout & 0.5 gpm Vandal Resistant Laminar flow outlet	\$522.00	4.7	205VL5
Gooseneck Spout, Deck Plate & 2.0 gpm Aerator	\$634.00	5.1	215
Gooseneck Spout, Deck Plate & 2.0 gpm Vandal Resistant Aerator	\$650.00	5.1	215VA
Gooseneck Spout, Deck Plate, 6" Lever Handle & 2.0 Aerator	\$651.00	5.3	0215-6
Gooseneck Spout, Deck Plate & 0.5 gpm Outlet	\$644.00	5.1	215A5
Gooseneck Spout, Deck Plate & 0.5 gpm Vandal Resistant Outlet	\$652.00	5.1	215V5
Gooseneck Spout, Deck Plate & 1.5 gpm Aerator+	\$643.00	5.1	215A15
Gooseneck Spout, Deck Plate & 2.0 gpm Laminar flow outlet	\$650.00	5.1	215L
Gooseneck Spout, Deck Plate & 2.0 gpm Vandal Resistant Laminar flow outlet	\$652.00	5.1	215VL
Gooseneck Spout, Deck Plate & 0.5 gpm Laminar flow outlet	\$665.00	5.1	215L5
Gooseneck Spout, Deck Plate & 0.5 gpm Vandal Resistant Laminar flow outlet	\$674.00	5.1	215VL5

+WaterSense applies to 1.5 gpm models only.

A WATTS Brand

LEAD FREE*

HydroGuard® Series LFe480 Lavatory Thermostatic Tempering Valves

Under the counter thermostatic mixer for lavatory applications.

ASSE 1070 and cUPC listed. Integral checks. Solid brass construction. Adjustable temperature with locking feature.

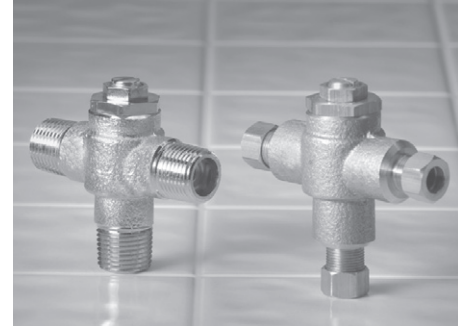

Description	Order Code	Weight	List Price
1/2" NPT inlets and outlet, Minimum Flow 0.25 gpm	LFG480-00	1.0	\$284.00
1/2" NPT inlets and outlet, Minimum Flow 0.25 gpm, Chrome Plated	LFG480-01	1.0	\$332.00
3/8" Compression inlets & outlet, Minimum Flow 0.25 gpm	LFG480-10	1.0	\$284.00
3/8" Compression inlets & outlet, Minimum Flow 0.25 gpm, Chrome Plated	LFG480-11	1.0	\$332.00
3/8" Quick Connect, Minimum Flow 0.25 gpm	LFG480-50	1.1	\$313.00
3/8" Quick Connect, Minimum Flow 0.25 gpm, Chrome plated . .	LFG480-51	1.1	\$361.00
1/2" NPT inlets and outlet, Minimum Flow 0.5 gpm	LFe480-00	1.0	\$284.00
1/2" NPT inlets & outlet, Chrome Plated, Minimum Flow 0.5 gpm	LFe480-01	1.0	\$332.00
3/8" Compression inlets & outlet, Minimum Flow 0.5 gpm	LFe480-10	1.0	\$284.00
3/8" Compression inlets & outlet, Chrome Plated, Minimum Flow 0.5 gpm	LFe480-11	1.0	\$332.00
3/8" Quick Connect, Minimum Flow 0.5 gpm	LFe480-50	1.1	\$313.00
3/8" Quick Connect, Chrome Plated, Minimum Flow 0.5 gpm . .	LFe480-51	1.1	\$361.00

LEAD FREE*

HydroGuard® Series LFLM490

HydroGuard® Series LFLM490 Thermostatic Tempering Valves for Hot Water Heaters and Multiple Lavatory Installations

All HydroGuard Series LFLM490 Valves feature advanced thermal actuator, adjustable lock-in handle design, solid brass construction and integral check valves and screens. CSA certified, ASSE 1017, and IAPMO listed.



Temperature Range 90° - 160°F (32° - 71°C) **Model LFLM49**

Temperature Range 60° - 120°F (16° - 49°C) **Model LFLM49** -10

Valve	List Price	Weight	Order Code
1/2"	\$ 295.00	1.8	0
3/4"	\$ 373.00	2.3	1
1"	\$ 447.00	2.9	2
Inlets/Outlets			
Union NPT Female	N/C	—	1
Union Sweat	N/C	—	2
Union CPVC	N/C	—	3
Union PEX	N/C	—	4
Quick-Connect			
1/2"	\$ 56.00	—	5
3/4"	\$ 80.00	—	5
1"	\$ 95.00	—	5
With Press			
1/2"	\$ 65.00	—	1-w/Press
3/4"	\$ 78.00	—	1-w/Press
1"	\$ 126.00	—	1-w/Press

*The wetted surface of this product contacted by consumable water contains less than 0.25% of lead by weight.

A WATTS Brand

LEAD FREE

HydroGuard® Series LFLM495 Thermostatic Tempering Valves for Individual Lavatory Installations

All HydroGuard® Series LFLM495 valves feature advanced thermal actuator, adjustable lock-in handle design, solid brass construction and integral check valves and screens. CSA certified, ASSE 1069, ASSE 1070 and IAPMO listed.

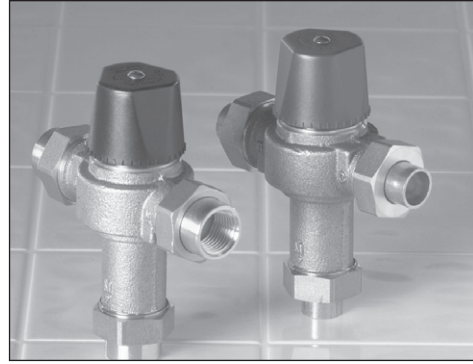

Model LFLM49 -

**Temperature Range 80° - 120° F
(27° - 49° C)**

Valve	List Price	Weight	Order Code
1/2"	\$312.00	1.8	5
3/4"	\$394.00	2.3	6
1"	\$464.00	2.9	7
Inlets/Outlets			
Union NPT Female	N/C	—	1
Union Sweat	N/C	—	2
Union CPVC	N/C	—	3
Union PEX	N/C	—	4
Quick-Connect		—	5
1/2"	\$56.00	—	5
3/4"	\$80.00	—	5
1"	\$95.00	—	5
With Press			
1/2"	\$ 65.00	—	1-w/Press
3/4"	\$ 78.00	—	1-w/Press
1"	\$ 126.00	—	1-w/Press

Hot Water Tank Capacity Extender

The hot water tank capacity extender increases hot water capacity as much as 133% depending on storage and cold water temperature flow.

	List Price	Weight	Ordering Code
3/4" Inlets & Outlet	\$ 461.00	3.0	LFLM496-HTK



*The wetted surface of this product contacted by consumable water contains less than 0.25% of lead by weight.

A WATTS Brand

LEAD FREE*

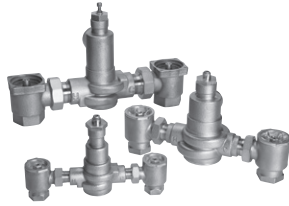

The HydroGuard® XP series LFMM430 is a temperature actuated mixing valve designed for use in hot water distribution system, in compliance with ASSE 1017 standard. Valve features advance paraffin actuation technology, dirt and lime resistant poppet and seat design and vandal resistant locking mechanism. Valve are available in two temperature ranges.

Valve	Rough Bronze		Chrome Plated	
	Standard (90-160°F)	Low (60-90°F)	Standard (90-160°F)	Low (60-90°F)
LFMM431 3/4 x 3/4	LFMM431-10 \$1,445.00	LFMM431-30 \$1,445.00	LFMM431-20 \$2,074.00	LFMM431-40 \$2,074.00
LFMM432 3/4 x 1	LFMM432-10 \$1,726.00	LFMM432-30 \$1,726.00	LFMM432-20 \$2,280.00	LFMM432-40 \$2,280.00
LFMM433 1 1/4 x 1 1/4	LFMM433-10 \$2,029.00	LFMM433-30 \$2,029.00	LFMM433-20 \$2,923.00	LFMM433-40 \$2,923.00
LFMM434 1 1/4 x 1 1/2	LFMM434-10 \$2,561.00	LFMM434-30 \$2,561.00	LFMM434-20 \$2,967.00	LFMM434-40 \$2,967.00
LFMM435 2 x 2	LFMM435-10 \$3,564.00	LFMM435-30 \$3,564.00	LFMM435-20 \$4,086.00	LFMM435-40 \$4,086.00

HydroGuard® XP Series LFMM430 Supply Fixtures

How to specify and order a supply fixture:

Valves (capacity at 45 psi)

- 23 gpm (87 lpm)
- 42 gpm (159 lpm)
- 64 gpm (242 lpm)
- 110 gpm (416 lpm)
- 144 gpm (545 lpm)
- 208 gpm (787 lpm)

Order Code

- LM490
- MM431
- MM432
- MM433
- MM434
- MM435

Valve and Pipe Finish

- Rough Bronze
- Chrome Plated

- A
- C

Piping Inlets/Outlets

- Top/Top
- Bottom/Top
- Bottom/Bottom
- Bottom/Side

- D
- E
- F
- G

Cabinet Style

- Exposed, no cabinet
- Stainless Steel, Recessed
- Stainless Steel, Semi-Recessed
- Stainless Steel, Wall Mounted
- Painted, Recessed
- Painted, Semi-Recessed
- Painted, Wall Mounted

- M
- N
- P
- Q
- R
- T
- U

Temperature Range

- Standard—90°F to 160°F (32°C to 71°C)
- Low**—60°F to 90°F (16°C to 32°C)

- S
- W

Options

- None
- Cold Water Bypass
- Combination T/P Gauge on inlets
- Cold Water Bypass & Combination T/P Gauge on inlets

- 0
- 2
- 4
- 6

Alarm System (Not Installed)

- None
- Aqua Sentry® 2 Alarm System

- 0
- 4

View Port

- None
- Window

- 0
- W



** Not available with LFLM490.

Note: Supply fixtures are made to order (MTO) and are not returnable or subject to credit.

*The wetted surface of this product contacted by consumable water contains less than 0.25% of lead by weight.

A WATTS Brand

LEAD FREE*

HydroGuard® XP Series LFMM430 Supply Fixtures

How to Determine the Price of a Supply Fixture

Determine the base price by looking in the first two columns of this chart, under "Valve and Pipe Finish." This price includes the valve and standard piping kit, dial thermometer, and a standard temperature range motor. If a cabinet, a high or low temperature motor or an optional piping kit is required, add the list price shown below to the base price.

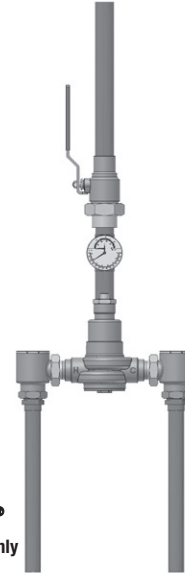

Valve only

Model LFMM432AEMS00

Order Code	Valve and Pipe Finish		Cabinet Style	
	Rough Bronze	Chrome Plated	Stainless Steel	Painted
	A	C	N,P,Q	R,T,U
LFLM490	\$1,706.00	\$1,871.00	\$1,754.00	\$1,169.00
LFMM431	\$2,548.00	\$2,802.00	\$2,178.00	\$1,286.00
LFMM432	\$3,080.00	\$3,250.00	\$2,178.00	\$1,286.00
LFMM433	\$3,577.00	\$4,015.00	\$2,178.00	\$1,286.00
LFMM434	\$4,320.00	\$4,853.00	\$2,178.00	\$1,286.00
LFMM435	\$5,723.00	\$6,862.00	\$2,602.00	\$1,704.00

Order Code	Cold Water Bypass	Combination T/P Gauge on Inlets	Options			Standard Items Available at No Charge
			Cold Water Bypass & Comb. T/P Gauge on Inlets	Aqua Sentry® 2	View Port	
	2	4	6	4	W	D, E, F, G, M, S, W
LFLM490	\$867.00	\$317.00	\$1,180.00	\$3,880.00	\$237.00	N/C
LFMM431	\$1,119.00	\$390.00	\$1,504.00	\$3,910.00	\$237.00	N/C
LFMM432	\$1,294.00	\$390.00	\$1,682.00	\$4,029.00	\$237.00	N/C
LFMM433	\$1,460.00	\$471.00	\$1,922.00	\$4,110.00	\$237.00	N/C
LFMM434	\$1,645.00	\$471.00	\$2,109.00	\$4,187.00	\$237.00	N/C
LFMM435	\$2,051.00	\$586.00	\$2,631.00	\$5,189.00	\$237.00	N/C

Note: Supply fixtures are made to order (MTO) and are not returnable or subject to credit.

*The wetted surface of this product contacted by consumable water contains less than 0.25% of lead by weight.

A WATTS Brand

LEAD FREE*

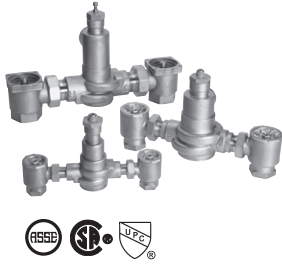

The HydroGuard® XP series LFSH1430 is a temperature actuated mixing valve designed for use in hot water distribution system, in compliance with ASSE 1017 standard. Valve features advanced paraffin actuation technology, dirt and lime resistant poppet and seat design and vandal resistant locking mechanism. Valve is available in two temperature ranges.

Valve	Valve Only			
	Rough Bronze		Chrome Plated	
	Standard (90-160°F)	Low (60-90°F)	Standard (90-160°F)	Low (60-90°F)
LFSH1432 3/4 x 1	LFSH1432-10 \$3,649.00	LFSH1432-30 \$3,649.00	LFSH1432-20 \$3,886.00	LFSH1432-40 \$3,886.00
LFSH1434 1 1/4 x 1 1/2	LFSH1434-10 \$5,214.00	LFSH1434-30 \$5,214.00	LFSH1434-20 \$5,513.00	LFSH1434-40 \$5,513.00
LFSH1435 2 x 2	LFSH1435-10 \$6,255.00	LFSH1435-30 \$6,255.00	LFSH1435-20 \$6,706.00	LFSH1435-40 \$6,706.00

Valve	Valve w/Temperature/Pressure Gauge on Outlet			
	Rough Bronze		Chrome Plated	
	Standard (90-160°F)	Low (60-90°F)	Standard (90-160°F)	Low (60-90°F)
LFSH1432 3/4 x 1	LFSH1432-11 \$3,888.00	LFSH1432-31 \$3,888.00	LFSH1432-22 \$4,172.00	LFSH1432-42 \$4,172.00
LFSH1434 1 1/4 x 1 1/2	LFSH1434-13 \$5,585.00	LFSH1434-33 \$5,585.00	LFSH1434-24 \$5,875.00	LFSH1434-44 \$5,875.00
LFSH1435 2 x 2	LFSH1435-15 \$6,736.00	LFSH1435-35 \$6,736.00	LFSH1435-26 \$7,087.00	LFSH1435-46 \$7,087.00

HydroGuard® XP Series LFSH1430 Supply Fixtures

How to specify and order a supply fixture:



	SH1432	SH1434	SH1435	Order Code
Valve and Piping Finish				
Rough Bronze	\$ 3,835.00	\$ 5,473.00	\$ 7,073.00	A
Chrome Plated.	\$ 4,364.00	\$ 6,144.00	\$ 8,053.00	C
Piping Inlets/Outlet				
Top/Top	N/C	N/C	N/C	D
Bottom/Top	N/C	N/C	N/C	E
Bottom/Bottom	N/C	N/C	N/C	F
Bottom/Side	N/C	N/C	N/C	G
Cabinet Style				
Exposed, no cabinet	N/C	N/C	N/C	M
Stainless Steel, Recessed	\$ 2,176.00	\$ 2,176.00	\$ 2,602.00	N
Stainless Steel, Semi-Recessed	\$ 2,176.00	\$ 2,176.00	\$ 2,602.00	P
Stainless Steel, Wall Mounted	\$ 2,176.00	\$ 2,176.00	\$ 2,602.00	Q
Painted, Recessed	\$ 1,286.00	\$ 1,286.00	\$ 1,704.00	R
Painted, Semi-Recessed.	\$ 1,286.00	\$ 1,286.00	\$ 1,704.00	T
Painted, Wall Mounted	\$ 1,286.00	\$ 1,286.00	\$ 1,704.00	U
Temperature Range				
Standard 90 - 160°F (32 - 71°C)	N/C	N/C	N/C	S
Low 60 - 90°F (16 - 32°C).	N/C	N/C	N/C	W
Option				
None.	N/C	N/C	N/C	0
Cold Water Bypass	\$ 1,294.00	\$ 1,645.00	\$ 2,050.00	2
Combination T/P Gauge on Inlets	\$ 390.00	\$ 469.00	\$ 585.00	4
Cold Water Bypass & Combination T/P Gauge on Inlets	\$ 1,682.00	\$ 2,107.00	\$ 2,631.00	6
Alarm System (Not Installed)				
None.	N/C	N/C	N/C	0
Aqua Sentry® 2 Alarm System	\$ 3,383.00	\$ 4,187.00	\$ 5,189.00	4
View Port				
None.	N/C	N/C	N/C	0
Window.	\$ 237.00	\$ 237.00	\$ 237.00	W

Note: Supply fixtures are made to order (MTO) and are not returnable or subject to credit.

*The wetted surface of this product contacted by consumable water contains less than 0.25% of lead by weight.

LEAD FREE*

The Lead Free HydroGuard® water tempering recirculating loop is an economical way to provide a safe, balanced system for stand alone master tempering valves. The system monitors return line temperature and automatically directs water to the cold side of the tempering valve (if within the set point) or to the hot water source (if below the set point).



HydroGuard® LF Recirculation Loop with Automatic Balancing System

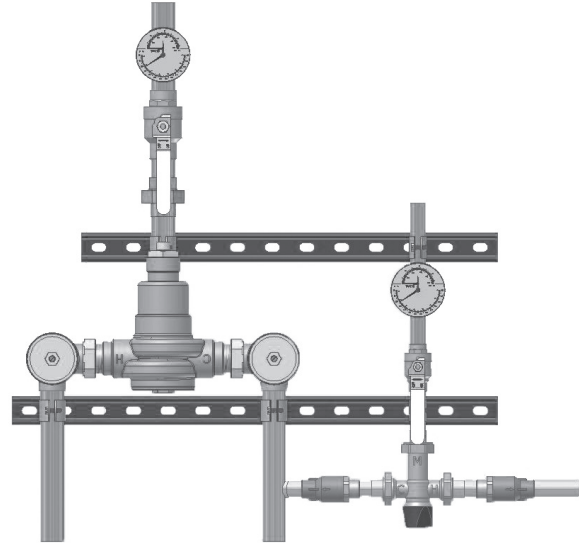

Valve Capacity @ 45 gpm	List Price
42 gpm (159 lpm)	\$ 3,606.00
64 gpm (242 lpm)	\$ 3,959.00
110 gpm (416 lpm)	\$ 4,554.00
144 gpm (545 lpm)	\$ 5,245.00
208 gpm (787 lpm)	\$ 6,392.00
57 gpm (216 lpm)	\$ 4,691.00
127 gpm (481 lpm)	\$ 6,156.00
201 gpm (761 lpm)	\$ 7,300.00

Valve & Piping Finish
 Rough Bronze N/C

Return Size
 3/4" N/C
 1" \$ 261.00

Temperature Range
 Standard (90° - 160° F) N/C
 Low (60° - 90° F) N/C

Alarm System (not installed)

None	N/C
Aqua Sentry® 2 for LFMM431	\$ 3,910.00
Aqua Sentry® 2 for LFMM432	\$ 4,029.00
Aqua Sentry® 2 for LFMM433	\$ 4,110.00
Aqua Sentry® 2 for LFMM434	\$ 4,187.00
Aqua Sentry® 2 for LFMM435	\$ 5,189.00
Aqua Sentry® 2 for LFSH1432	\$ 3,383.00
Aqua Sentry® 2 for LFSH1434	\$ 4,187.00
Aqua Sentry® 2 for LFSH1435	\$ 5,189.00

LF R **A**

Order Code	
MM431	
MM432	
MM433	
MM434	
MM435	
SH1432	
SH1434	
SH1435	
A	
B	
C	
S	
W	
0	
1	
2	
3	
4	
5	
6	
7	
8	

Note: These products are specially made and are not returnable or subject to credit.

*The wetted surface of this product contacted by consumable water contains less than 0.25% of lead by weight.

A WATTS Brand

LEAD FREE*

Hi/Lo Supply Fixtures

Hi/Lo Supply Fixtures include two master mixing valves, a pressure regulating valve, outlet thermometer, shutoff valve, and pressure gauges. Piping configuration is bottom inlets/top outlet. For other configurations, consult Powers Technical Support Department.

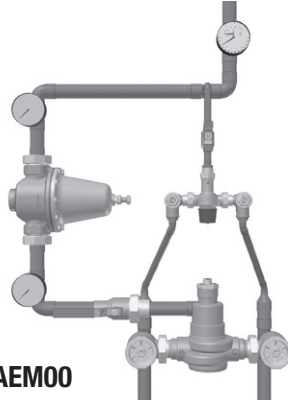

LFMM432HLAEM00

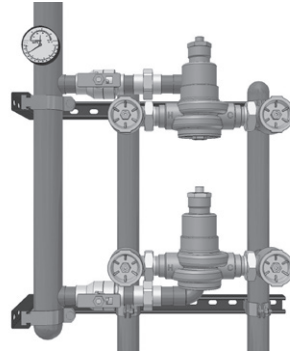

LFSH1434DVAEM00

LF

Valve Configuration	Capacity	Inlets	Outlet	List Price	Order Code
LFLM490/LFMM431	0.5 - 65 gpm	3/4"	3/4"	\$6,628.00	MM431HL
LFLM490/LFMM432	0.5 - 87 gpm	3/4"	1"	\$7,208.00	MM432HL
LFLM490/LFMM433	0.5 - 133 gpm	1-1/4"	1-1/4"	\$7,834.00	MM433HL
LFLM490/LFMM434	0.5 - 167 gpm	1-1/4"	1-1/2"	\$8,458.00	MM434HL
LFMM431/LFMM434	3.0 - 186 gpm	1-1/4"	1-1/2"	\$10,259.00	MM435HL
Larger Size					
LFMM434/LFSH1432	1.0 - 201 gpm	1-1/2"	2"	\$10,574.00	SH1432HL
LFMM434/LFSH1434	1.0 - 271 gpm	2"	2-1/2"	\$11,202.00	SH1434HL
LFSH1432/LFSH1434	2.0 - 184 gpm	1-1/2"	2"	\$9,546.00	SH1432DV
LFSH1434/LFSH1434	2.0 - 251 gpm	2"	2-1/2"	\$10,775.00	SH1434DV
LFSH1435/LFSH1435	10 - 402 gpm	4"	4"	\$20,411.00	SH1435DV

Finish
Rough Bronze N/C

Piping Inlets/Outlet
Bottom/Top N/C
Top/Top \$362.00

Cabinet
Exposed, No Cabinet N/C
Stainless Steel, Recessed \$3,713.00
Stainless Steel, Wall Mounted \$3,713.00
Painted, Recessed \$3,184.00
Painted, Wall Mounted \$3,184.00

Alarm (not installed)**
None N/C
Aqua Sentry® 2 for LFMM431 HL \$3,910.00
Aqua Sentry® 2 for LFMM432 HL \$4,029.00
Aqua Sentry® 2 for LFMM433 HL \$4,110.00
Aqua Sentry® 2 for LFMM434 HL \$4,187.00
Aqua Sentry® 2 for LFMM435 HL \$4,187.00
Aqua Sentry® 2 for LFSH1432DV \$5,189.00
Aqua Sentry® 2 for LFSH1432HL \$5,189.00

View Port
None N/C
Window \$237.00

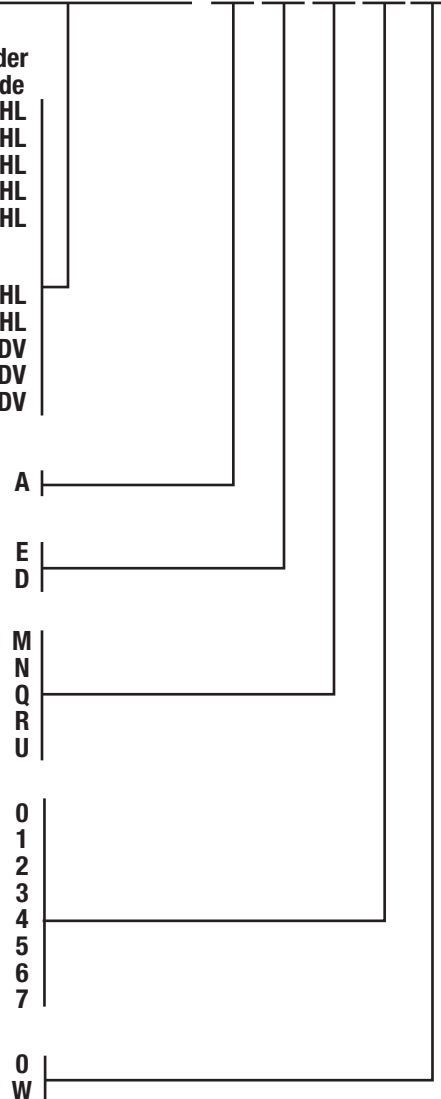

*The wetted surface of this product contacted by consumable water contains less than 0.25% of lead by weight.
**Not available with LFSH1434DV, LFSH1434HL & LFSH1435DV

Note: These products are specially made and are not returnable or subject to credit.

A WATTS Brand

LEAD FREE*

Powers' High Capacity Systems are fully assembled and factory tested. They are designed to provide safe tempered water throughout commercial and institutional facilities. They consist of LFMM434 and LFSH1434 HydroGuard® XP thermostatic tempering valves. Each system includes ball valves, thermometers, pressure gauges, triple-duty check valves and PRV. Each system is supported by heavy-duty welded struts. Piping configuration is bottom inlets and top outlets.

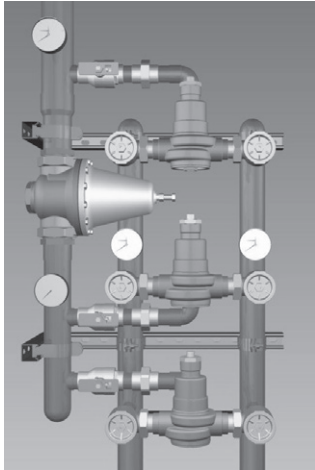

LFSH1434TVAEMO

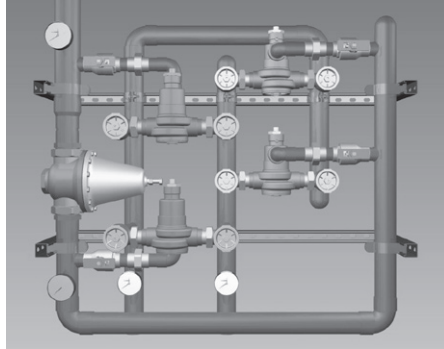

LFSH1434QVAEMO

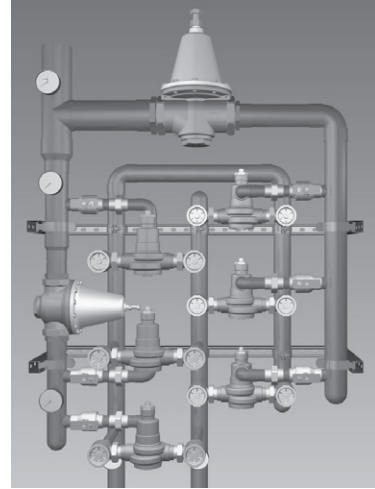

LF14346VAEMO



LF

Valve Configuration	Capacity	Inlets	Outlet	List Price	Order Code
1- LFSH1434 & 2- LFMM434	1.0 - 416 gpm	2-1/2"	3"	Per Application Contact POWERS	SH1434TV
1- LFSH1434 & 3- LFMM434	1.0 - 559 gpm	2-1/2"	3"		SH1434QV
1- LFSH1434 & 5- LFMM434	1.0 - 847 gpm	2-1/2"	4"		SH14346V
Finish					
Rough Bronze				N/C	A
Piping Inlets/Outlet					
Bottom/Top				N/C	E
Cabinet					
Exposed, No Cabinet				N/C	M
Stainless Steel, Wall Mounted				Per Application Contact Powers	Q
Painted, Wall Mounted					U
Alarm (Not Installed)					
None				N/A	0

Note: These products are specially made and are not returnable or subject to credit.

*The wetted surface of this product contacted by consumable water contains less than 0.25% of lead by weight.

A WATTS Brand

LEAD FREE*

The IntelliStation™ is a digital water mixing station and recirculation system providing user-directed control and monitoring of water distribution system. IntelliStation™ includes an electronic control module featuring a color touch screen digital display to select desired outlet water temperature, an electronically actuated valve, temperature sensors (plus a quick response temperature sensor), pressure sensors and check valves. The IntelliStation™ monitors hot supply inlet temperature, hot supply pressure, mixed outlet temperature, mixed outlet pressure, return temperature, and return pressure to help maintain the desired outlet temperature. IntelliStation™ also features a user programmable high temperature Sanitization mode to help limit water-borne bacteria as part of a user-directed and controlled thermal eradication protocol. Each IntelliStation™ is mounted on heavy-duty, welded struts as a complete unit. Optional equipment includes engineer specified circulator, flow/BTU package and strainers. The IntelliStation™ Control Module supports building automation system (BAS) communication with BACnet® IP, BACnet® MSTP, and Modbus® protocols, allowing remote programing and data viewing.

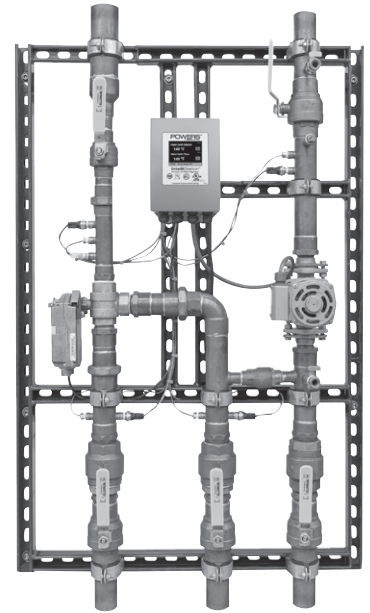

Shown with optional pump

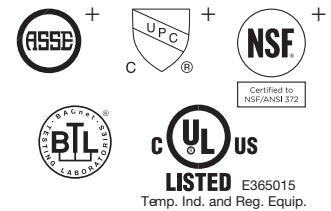

Standard Capacity

Valve	Inlets	Outlet		Order Code
LFIS150	2"	2 1/2"	Per Application Contact Powers	LFIS150
LFIS200	2 1/2"	3"		LFIS200
Return Pipe Size				
1"				C
2"				F
Flow/BTU Package				
None				O
Flow/BTU Package				F
Strainers**				
None				O
On inlets				S
Pump				
Less Pump				LP
Pump Assigned by Factory				--

Must Provide Following Pump Information to Factory to Select the Pump:

Pump Manufacturer: _____
 Their Part/Model # _____
 System Head Loss _____
 Required Flow to Maintain Recirculating Temperature _____

**Strainer ship loose and must be installed by a plumber at the jobsite.

High Capacity

Valve	Inlets	Outlet		Order Code
LFIS150/LFIS150	4"	4"	Per Application Contact Powers	LFIS150DV
LFIS200/LFIS200	6"	6"		LFIS200DV
LFIS200/LFIS200/ LFIS200	6"	6"		LFIS200TV
Return Pipe Size				
3"				H
Flow/BTU Package				
None				O
Flow/BTU Package				F
Strainers				
None				O
On inlets				S
Pump				
Less Pump				LP
Pump Assigned by Factory				--

Must Provide Following Pump Information to Factory to Select the Pump:

Pump Manufacturer: _____
 Their Part/Model # _____
 System Head Loss _____
 Required Flow to Maintain Recirculating Temperature _____

Note: These products are specially made and are not returnable or subject to credit.

*The wetted surface of this product contacted by consumable water contains less than 0.25% of lead by weight.

+ Listed without pump

A WATTS Brand

LEAD FREE*

The IntelliStation Jr. is a digital mixing valve providing user-directed control and monitoring of water distribution system. IntelliStation Jr. includes an electronic control module featuring a color touch screen, an electronically actuated valve and a mixed outlet temperature sensor. IntelliStation Jr. also features a user programmable high temperature Sanitization mode to help limit water-borne bacteria as a part of a user-directed and controlled thermal eradication protocol. The IntelliStation Jr. control module support building automation system (BAS) communication with BACnet MSTP and Modbus protocols, allowing remote programming and data viewing.



Standard Capacity

Valve	Inlets	Outlet
LFIS075VL	3/4"	3/4"
LFIS100VL	1"	1 1/4"
LFIS150VL	1 1/2"	1 1/2"
LFIS200VL	2"	2"

List Price

Contact Powers

Order Code

LFIS075VL
LFIS100VL
LFIS150VL
LFIS200VL



Options Available

Cabinets

Stainless Steel, Wall Mounted
Painted, Wall Mounted

Contact Powers

Q
U

View Port

None
Window

Contact Powers

O
W

IntelliStation® Jr. System

Valve	Inlets	Outlet
LFIS075VL	1"	1"
LFIS100VL	1 1/4"	1 1/2"
LFIS150VL	2"	2"
LFIS200VL	2 1/2"	2 1/2"

List Price

Contact Powers

Order Code

LFIS075VL-SYS075RTN
LFIS100VL-SYS100RTN
LFIS150VL-SYS150RTN
LFIS200VL-SYS200RTN



A **WATTS** Brand

LEAD FREE*

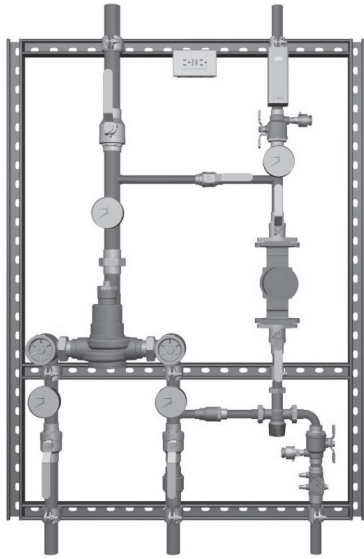

Shown with optional pump

PowerStation is a complete, fully assembled water tempering system, designed to provide safe tempered water throughout commercial and institutional facilities. PowerStation features the HydroGuard® XP LFMM430 or LFSH1430 tempering series valve with advanced thermal actuation technology. Each PowerStation is mounted on heavy-duty, welded struts and is factory tested as a complete system. Each PowerStation includes an engineer specified circulator, GFCI outlet, combination temperature/pressure gauges and Powers' triple-duty checkstops and internal bypass loop for fast and easy set-up. Optional equipment includes an Aquastat and/or Powers' exclusive automatic balancing valve.



Valve	Capacity	Inlet	Outlet
LFSH1432	1 - 57 gpm	3/4"	1"
LFSH1434	1 - 127 gpm	1-1/4"	1-1/2"
LFSH1435	5 - 201 gpm	2"	2"
LFMM431	3 - 42 gpm	3/4"	3/4"
LFMM432	4 - 64 gpm	3/4"	1"
LFMM433	5 - 110 gpm	1-1/4"	1-1/4"
LFMM434	7 - 144 gpm	1-1/4"	1-1/2"
LFMM435	10 - 208 gpm	2"	2"

List Price
Per Application Contract Powers

Controls

None	O
Aquastat	A
Aqua Sentry® 2**	B
Aquastat & Aqua Sentry® 2**	C

Balancing Valves

None	O
Automatic Balancing Valve	B

Return Pipe Size

1/2"	A
3/4"	B
1"	C
1-1/4"	D
1-1/2"	E
2"	F

Assigned by Factory

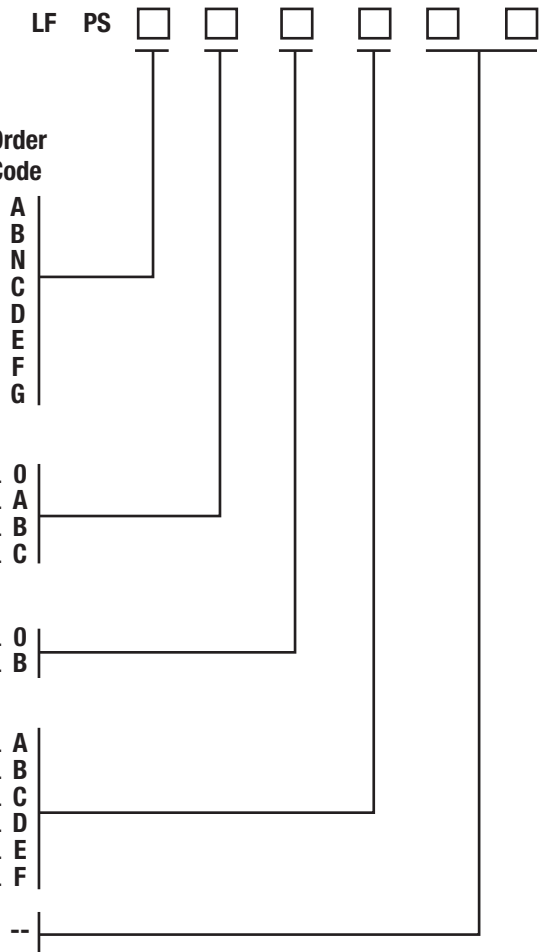

Pump Information:

Call Powers Technical Service at 800-669-5430 for pump selection. You must provide the following information. Pump shall be lead free.

System Head Loss _____

Required Flow to Maintain Recirculating Temp. _____

Note: These products are specially made and are not returnable or subject to credit.

*The wetted surface of this product contacted by consumable water contains less than 0.25% of lead by weight.
**Aqua Sentry® 2 - not installed

A WATTS Brand

LEAD FREE™

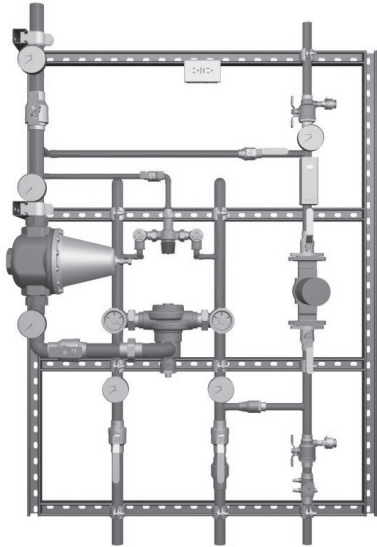

Shown with optional pump

PowerStation™ is a complete, fully assembled water tempering system, designed to provide safe tempered water throughout commercial and institutional facilities. PowerStation™ features the HydroGuard® XP LFLM490, LFMM430 and/or LFSH1430 tempering series valve with advanced thermal actuation technology. Each PowerStation™ is mounted on heavy-duty, welded struts and is factory tested as a complete system. It also includes an engineer specified circulator, GFCI outlet, combination temperature/pressure gauges, Powers' triple-duty checkstops and internal bypass loop for fast and easy set-up. Optional equipment includes an Aquastat and/or Powers' exclusive automatic balancing valve.



Valve	Capacity	Inlets	Outlet	List Price	Order Code	LF	PS	<input type="checkbox"/>	<input type="checkbox"/>	<input type="checkbox"/>	<input type="checkbox"/>	<input type="checkbox"/>	<input type="checkbox"/>	
LFMM431HL	0.5 - 65 gpm	3/4"	3/4"	Per Application Contact POWERS	H									
LFMM432HL	0.5 - 87 gpm	3/4"	1"		J									
LFMM433HL	0.5 - 133 gpm	1-1/4"	1-1/4"		K									
LFMM434HL	0.5 - 167 gpm	1-1/4"	1-1/2"		L									
LFMM435HL	3 - 186 gpm	1-1/4"	1-1/2"		M									
LFSH1432HL	1 - 201 gpm	1-1/2"	2"		P									
LFSH1434HL	1 - 271 gpm	2"	2-1/2"		Q									
LFSH1432DV	2 - 184 gpm	1-1/2"	2"		S									
LFSH1434DV	2 - 251 gpm	2"	2-1/2"		T									
LFSH1434TV	1 - 416 gpm	2-1/2"	3"		W									
LFSH1435DV	10 - 402 gpm	4"	4"		X									
Controls														
None						O								
Aquastat						A								
Aqua Sentry® 2**						B								
Aquastat & Aqua Sentry® 2**						C								
Balancing Valve														
None					O									
Automatic Balancing Valve					B									
Return Pipe Size														
1/2"					A									
3/4"					B									
1"					C									
1-1/4"					D									
1-1/2"					E									
2"					F									
Assigned by Factory														
					--									

Pump Information:

Call Powers Technical Service at 800-669-5430 for pump selection. You must provide the following information. Pump shall be lead free.

System Head Loss _____

Required Flow to Maintain Recirculating Temp. _____

Note: These products are specially made and are not returnable or subject to credit.

*The wetted surface of this product contacted by consumable water contains less than 0.25% of lead by weight.
 **Aqua Sentry® 2 - not installed and not available on LFSH1434HL, LFSH1434DV, LFSH1434TV, LFSH1435DV.

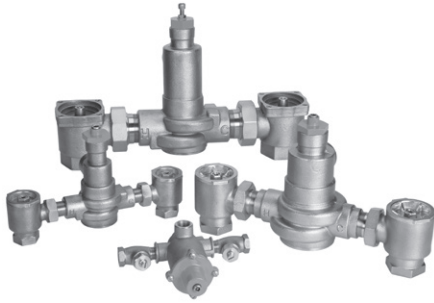

The HydroGuard® XP Emergency Tempering valves, with cold water bypass, are designed to use with emergency fixtures in compliance with ANSI Z358.1 2014 and are ASSE 1071 listed. Valves feature advanced paraffin actuation technology, dirt and lime resistant poppet and seat design and vandal resistant locking mechanism. Valves are available in two finishes.



Valve	Valve Only	
	Rough Bronze	Chrome Plated
ES150 1/2 x 1/2	ES150-10 \$1,084.00	ES150-20 \$1,217.00
ETV200 3/4 x 1	ETV200-10 \$1,706.00	ETV200-20 \$1,908.00
ETV400 1 1/4 x 1 1/2	ETV400-10 \$2,657.00	ETV400-20 \$2,911.00
ETV500 2 x 2	ETV500-10 \$3,628.00	ETV500-20 \$3,960.00

Valve	Valve w/Temperature/Pressure Gauge on Outlet	
	Rough Bronze	Chrome Plated
ES150 1/2 x 1/2	ES150-11 \$1,126.00	ES150-22 \$1,262.00
ETV200 3/4 x 1	ETV200-13 \$1,925.00	ETV200-24 \$1,992.00
ETV400 1 1/4 x 1 1/2	ETV400-15 \$2,779.00	ETV400-26 \$3,170.00
ETV500 2 x 2	ETV500-17 \$3,793.00	ETV500-28 \$4,130.00

A WATTS Brand

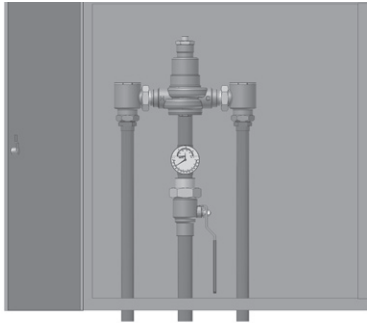

The HydroGuard® XP Emergency Tempering valves, with cold water bypass, are designed to use with emergency fixtures in compliance with ANSI Z358.1 2004 and are ASSE 1071 listed. Valves feature advanced paraffin actuation technology, dirt and lime resistant poppet and seat design and vandal resistant locking mechanism. Valves are available in two finishes.



	ES150	ETV200	ETV400	ETV500	Ordering Code
Valve and Piping Finish					
Rough Bronze	\$ 1,293.00	\$ 2,040.00	\$ 3,115.00	\$ 3,581.00	A
Chrome Plated	\$ 1,478.00	\$ 2,378.00	\$ 3,787.00	\$ 4,209.00	B
Piping Inlets/Outlet					
Top/Top	N/C	N/C	N/C	N/C	D
Top/Bottom	N/C	N/C	N/C	N/C	M
Bottom/Top	N/C	N/C	N/C	N/C	E
Bottom/Bottom	N/C	N/C	N/C	N/C	F
Bottom/Side	N/C	N/C	N/C	N/C	G
Cabinet Style					
Exposed, no cabinet	N/C	N/C	N/C	N/C	O
Stainless Steel, Recessed	\$ 1,264.00	\$ 2,178.00	\$ 2,178.00	\$ 2,601.00	N
Stainless Steel, Semi-Recessed	\$ 1,264.00	\$ 2,178.00	\$ 2,178.00	\$ 2,601.00	P
Stainless Steel, Wall Mounted	\$ 1,264.00	\$ 2,178.00	\$ 2,178.00	\$ 2,601.00	Q
Painted, Recessed	\$ 1,056.00	\$ 1,286.00	\$ 1,286.00	\$ 1,704.00	R
Painted, Semi-Recessed	\$ 1,056.00	\$ 1,286.00	\$ 1,286.00	\$ 1,704.00	T
Painted, Wall Mounted	\$ 1,056.00	\$ 1,286.00	\$ 1,286.00	\$ 1,704.00	U
Option					
None	N/C	N/C	N/C	N/C	0
T/P Gauge on Inlets	\$ 240.00	\$ 296.00	\$ 357.00	\$ 446.00	5
Alarm System (not installed)					
None	N/C	N/C	N/C	N/C	0
Aqua Sentry® 2	\$ 3,854.00	\$ 4,029.00	\$ 4,187.00	\$ 5,189.00	4
View Port					
None	N/C	N/C	N/C	N/C	0
Window	\$ 237.00	\$ 237.00	\$ 237.00	\$ 237.00	W

Note: These products are made to order (MTO) and are not returnable or subject to credit.

Hydropanel II Modular Shower Systems with e700 T/P Series Valve

Hydropanel II Shower Systems are constructed from stainless steel. They feature HydroGuard T/P Series e700 combination mixing valves with ABS or Metal handles, vandal-resistant fasteners, color-coded graphics, end caps, and are factory-tested and pre-assembled.









Model 4507100









Model 4507054 

Hydropanel II with e705 Combination Mixing Valves with ABS Handles

Description	Order Code	Weight (lbs.)	List Price
Fixed Showerhead and Soap Dish	4507050	15.0	\$1,210.00
Fixed Showerhead, less Soap Dish	4507051	14.0	\$1,210.00
Swivel Showerhead and Soap Dish	4507052	15.0	\$1,210.00
Swivel Showerhead, less Soap Dish	4507053	14.0	\$1,210.00
Professional Hand Shower, Glide Rail, VB and Soap Dish 	4507054	17.0	\$1,461.00
Professional Hand Shower, Glide Rail, VB, less Soap Dish 	4507055	16.0	\$1,461.00
Deluxe Hand Shower, Glide Rail, VB and Soap Dish 	4507056	18.0	\$1,506.00
Deluxe Hand Shower, Glide Rail, VB, less Soap Dish 	4507057	17.0	\$1,506.00
Professional Hand Shower, Glide Rail, VB, Fixed Showerhead and Soap Dish 	4507058	18.0	\$2,106.00
Professional Hand Shower, Glide Rail, VB, Swivel Showerhead and Soap Dish 	4507059	19.0	\$2,106.00

Hydropanel II with e710 Combination Mixing Valves with Metal Handles

Description	Order Code	Weight (lbs.)	List Price
Fixed Showerhead and Soap Dish	4507100	15.0	\$1,232.00
Fixed Showerhead, less Soap Dish	4507101	14.0	\$1,232.00
Swivel Showerhead and Soap Dish	4507102	15.0	\$1,232.00
Swivel Showerhead, less Soap Dish	4507103	14.0	\$1,232.00
Professional Hand Shower, Glide Rail, VB and Soap Dish 	4507104	17.0	\$1,483.00
Professional Hand Shower, Glide Rail, VB, less Soap Dish 	4507105	16.0	\$1,483.00
Deluxe Hand Shower, Glide Rail, VB and Soap Dish 	4507106	18.0	\$1,528.00
Deluxe Hand Shower, Glide Rail, VB, less Soap Dish 	4507107	17.0	\$1,528.00
Professional Hand Shower, Glide Rail, VB, Fixed Showerhead and Soap Dish 	4507108	18.0	\$2,128.00
Professional Hand Shower, Glide Rail, VB, Swivel Showerhead and Soap Dish 	4507109	19.0	\$2,128.00

Hydropanel II Modular Shower Systems

Hydropanel II Shower Systems are constructed from stainless steel. They feature a pressure balance or thermostatic mixing valve with metal lever handle, vandal-resistant fasteners, color-coded graphics, end caps, and are factory-tested and pre-assembled.





Model 4504002







Model 4504210E 



Model 4500416P 

Hydropanel II with Biltmore 900 Pressure Balancing Valve	Order Code	Weight (lbs.)	List Price
Hydropanel II with Fixed Showerhead and Soap Dish	4504000	15.0	\$1,153.00
Hydropanel II with Fixed Showerhead, less Soap Dish	4504001	14.0	\$1,153.00
Hydropanel II with Swivel Showerhead and Soap Dish	4504002	15.0	\$1,153.00
Hydropanel II with Swivel Showerhead, less Soap Dish	4504003	14.0	\$1,153.00
Hydropanel II with Professional Hand Shower, Glide Rail, VB and Soap Dish 	4504004	17.0	\$1,397.00
Hydropanel II with Professional Hand Shower, Glide Rail, VB, less Soap Dish 	4504005	16.0	\$1,397.00
Hydropanel II with Deluxe Hand Shower, Glide Rail, VB and Soap Dish 	4504006	18.0	\$1,462.00
Option: Metering Valve Only.....	Suffix M		Add: \$422.00
Metering Valve with Pressure Balancing.....	Suffix MP		Add: \$619.00

Hydropanel II with HydroGuard PB410 Pressure Balancing Valve	Order Code	Weight (lbs.)	List Price
Hydropanel II with Fixed Showerhead and Soap Dish	4500416P	15.0	\$1,377.00
Hydropanel II with Fixed Showerhead, less Soap Dish	4500417P	14.0	\$1,377.00
Hydropanel II with Swivel Showerhead and Soap Dish	4500418P	15.0	\$1,377.00
Hydropanel II with Swivel Showerhead, less Soap Dish	4500419P	14.0	\$1,377.00
Hydropanel II with Hand Shower VB and Soap Dish 	4500420P	17.0	\$1,624.00
Hydropanel II with Hand Shower, VB, less Soap Dish 	4500421P	16.0	\$1,624.00
Hydropanel II with Diverter, Deluxe Hand Shower, VB, Fixed Showerhead, and Soap Dish 	4504104P	17.0	\$2,949.00

Hydropanel II with HydroGuard e420 Thermostatic Mixing Valve	Order Code	Weight (lbs.)	List Price
Hydropanel II with Fixed Showerhead and Soap Dish	4504210E	15.0	\$1,605.00
Hydropanel II with Fixed Showerhead, less Soap Dish	4504211E	14.0	\$1,605.00
Hydropanel II with Swivel Showerhead and Soap Dish	4504212E	15.0	\$1,605.00
Hydropanel II with Swivel Showerhead, less Soap Dish	4504213E	14.0	\$1,605.00
Hydropanel II with Hand Shower VB and Soap Dish 	4504214E	17.0	\$1,856.00
Hydropanel II with Hand Shower, VB, less Soap Dish 	4504215E	16.0	\$1,856.00

	Order Code	Weight (lbs.)	List Price
Hydropanel II Dual Shower with Diverter			
Hydropanel II with Diverter, Deluxe Hand Shower, VB, Fixed Showerhead and 900 Series Pressure Equalizing Valve, Soap Dish 	4504103	22.0	\$2,402.00
Hydropanel II Tub/Shower with Biltmore 900 Pressure Balancing Valve			
Hydropanel II with Fixed Showerhead, Diverter Spout and 900 Series Pressure Equalizing Valve with Soap Dish	4504031	22.0	\$1,859.00
Hydropanel II Modular Shrouding System			
Horizontal Adaptor Kit, 16"	4504040	3.8	\$221.00
Horizontal Adaptor Kit, 24"	4504041	6.9	\$209.00
Horizontal Adaptor Kit, 48"	4504042	13.0	\$300.00
Overlay Shroud Kit, 8"	4504043	1.6	\$146.00
Overlay Shroud Kit, 13"	4504044	2.6	\$153.00
Overlay Shroud Kit, 16"	4504045	3.7	\$165.00
Overlay Shroud Kit, 18"	4504046	4.2	\$175.00
Overlay Shroud Kit, 23"	4504047	6.4	\$188.00
Overlay Shroud Kit, 28"	4504048	5.5	\$200.00
Extension Shroud Kit, 6"	4504050	1.6	\$143.00
Extension Shroud Kit, 24"	4504051	4.2	\$188.00
Corner Shroud Kit, 10"	4504049	2.2	\$152.00
Corner MTG Kit**	4500430	1.0	NLA
Corner End Cap	4504015	0.7	NLA
End Cap Kit	4504011	0.1	\$40.00

See page 31 for ESP™ Infrared and Piezo Proximity Hydropanel Systems.

HydroGuard® ESP Infrared Showers

Powers ESP Infrared Showers are supplied complete with the sensor assembly, 24 VAC solenoid valve, modular junction box and mounting hardware. Optional box mount or plug-in transformer available. Hand showers and diverters are optional as well.

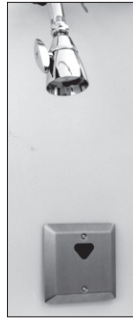

HydroGuard® Piezo Sensor Showers

Powers ESP Piezo Showers are supplied complete with 24 VAC solenoid valve, installation kit, and control box. Optional box-mount or plug-in transformer available. (Piezo shower is also available for multiple shower applications.)



ADA compliant

	List Price
Sensor	
Infrared	\$1,437.00
Piezo	NLA
for wall depth 0-.25"	NLA
for wall depth .26"-1.5"	\$1,120.00
for wall depth 1.6"-4.5"	\$1,133.00
for wall depth 4.6"-6.5"	\$1,178.00
for wall depth 6.6"-8.5"	\$1,202.00
Transformer (Order separately-See below)	
None	N/C
Control Box	
Individual Control (For Piezo)	N/C
Less Box (For Infrared)	N/C
Showerhead	
None	N/C
Adj. Brass/Arm and Flange	\$72.00
Adj. Brass/Arm and Flange	\$98.00
Institutional (141 381)	NLA
Institutional (141 868)	\$301.00
Institutional (141903A)	\$257.00
Institutional (141903B)	\$282.00
Institutional (141903C)	\$25.00
Hand Shower	
None	N/C
Deluxe (141 163) w/VB (141 319)	\$478.00
Standard (141 827) w/VB (141 319)	\$314.00
Diverter	
None	N/C
Concealed (141600B)	\$222.00
Concealed (141600E)	\$237.00
Concealed (141600F)	\$244.00
Transformer	
Box (444 119)	\$133.00

Order Code	447- <input type="text" value="0"/> <input type="text" value="0"/> <input type="text" value=""/> <input type="text" value=""/> <input type="text" value=""/> <input type="text" value=""/> <input type="text" value=""/> <input type="text" value=""/>
1	
3	
4	
5	
6	
7	
00	
IC	
00	
00	
K1	
M1	
NO	
PO	
QO	
RO	
SO	
0	
6	
8	
0	
Y	
A	
B	

Hydropanel ESP Infrared Showers

Powers Hydropanel ESP Infrared Showers are supplied complete with the sensor assembly and 24 VAC solenoid valve pre-piped in a stainless steel shroud. Modular junction box and mounting hardware included, as well as optional box mount or plug-in 24 VAC transformer.



Hydropanel ESP Piezo Showers

Powers Hydropanel ESP Piezo Showers are supplied complete with the assembly, proximity sensor assembly, and 24 VAC solenoid valve, pre-piped in a stainless steel shroud. Control box and mounting hardware included.



ADA compliant

.....List	Price
Sensor	
Infrared.....	\$ 2,618.00
Piezo.....	\$ 2,105.00

Transformer (Order separately-See below)

None.....	N/C
-----------	-----

Control Box

Individual Control (Push Button).....	N/C
Less Box (Infrared only).....	N/C

Showerhead

Fixed Head.....	N/C
Swivel Head.....	N/C
Professional Hand Shower (141 318) w/VB (141 319).....	\$ 321.00
Deluxe Hand Shower (141 163) w/VB (141 319).....	\$ 350.00
Standard Hand Shower (141 827) w/VB (141 319).....	\$ 313.00
Fixed Head, Standard Hand Shower, VB (141 319) and Diverter (141600B).....	\$ 573.00
Fixed Head, Deluxe Hand Shower, VB (141 319) and Diverter (141600B).....	\$ 702.00

Soap Dish

With Soapdish.....	N/C
Less Soapdish.....	N/C

Transformer

Box (444 119).....	\$ 133.00
--------------------	-----------

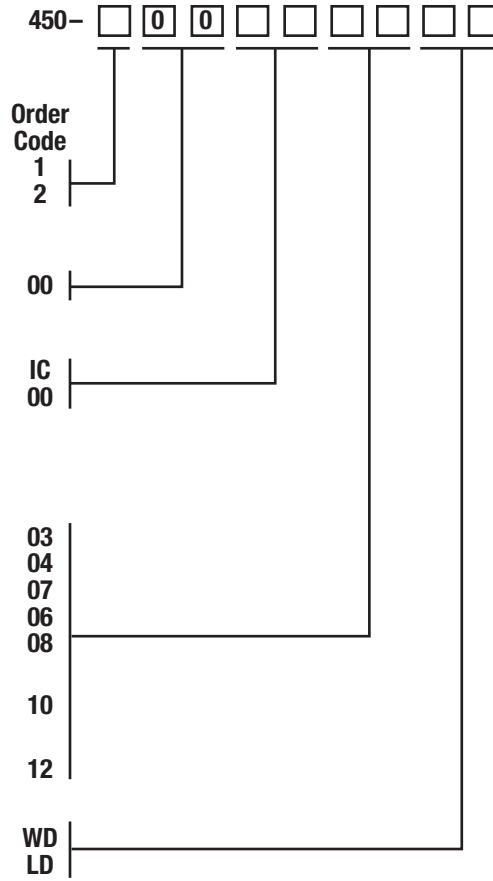

A WATTS Brand

LEAD FREE*

Aqua Sentry® 2 Series LF460 Alarm System

Audibly and visibly warns and shuts down supply if water temperature exceeds high or low set-points.

Aqua Sentry® 2 Alarm System, complete

Includes the Aqua Sentry® 2 control module, temperature sensor with phone-style jack, sensor junction box, 4 x 4 electrical box, UL/CSA approved 24 VAC, class 2 transformer, and 25 feet of station cable.

Order Code	Weight	List Price
LF4600150	8.0 lbs.	\$1,540.00

Motorized Ball Valve, cable, and shock absorber must be ordered separately. See below.

Accessories for Aqua Sentry® 2

Motorized Ball Valves - 24 VAC

	Order Code	Weight	List Price
1/2"	LF460070	9 lbs.	\$1,577.00
3/4"	LF460071	10 lbs.	\$1,607.00
1"	LF460072	11 lbs.	\$1,723.00
1-1/4"	LF460073	11 lbs.	\$1,798.00
1-1/2"	LF460074	12 lbs.	\$1,879.00
2"	LF460075	14 lbs.	\$2,853.00

Cable

Telephone station cable

Order Code	List Price
460 339	\$3.10/foot

Shock Absorber

1" NPT, stainless steel, nitrogen-charged.

Order Code	Weight	List Price
460 353	1.0 lbs.	\$733.00

Components

460 602	Aqua Sentry® 2 Transformer, Class 2, 24 VAC, UL/CSA-approved, 4 lbs.	\$167.00
460 601	Temperature Sensor with Phone Jack	\$384.00

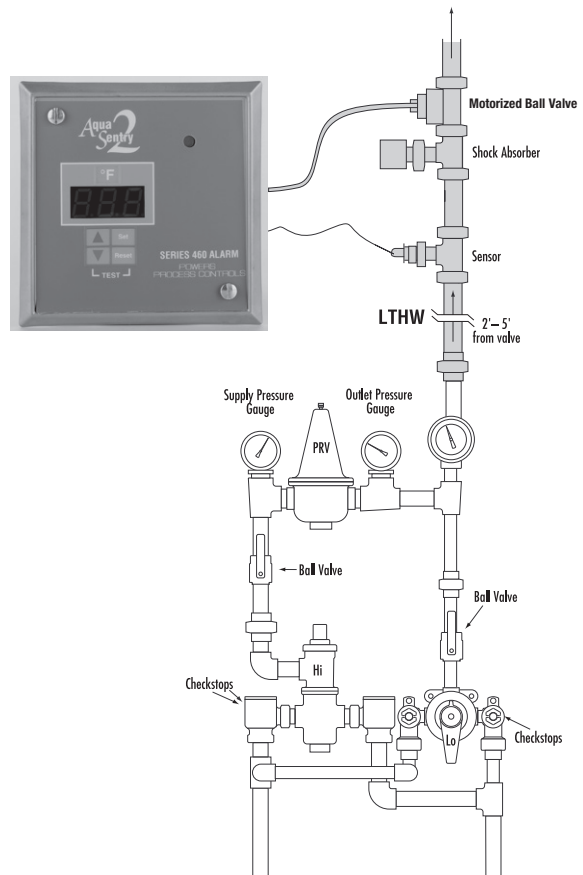

*The wetted surface of this product contacted by consumable water contains less than 0.25% of lead by weight.

Fotoguard and Fotopanel Series 440

For precise control of water temperature for photographic processing.



Fotoguard

Fotopanel



Fotoguard

Description	Order Code	Capacity	Outlets	Weight	List Price
Concealed—Stainless steel faceplate with temperature indication, volume control, inlet strainer checkstops.	4401550	1–6 gpm	1/2"	7.5 lbs.	\$1,427.00
Exposed—Chrome-plated finish, inlet strainer checkstops, volume control.	4401500	1–6 gpm	1/2"	7.8 lbs.	\$1,952.00
	4401510	5–14 gpm	1/2"	9.5 lbs.	\$2,178.00

Fotoguard Supply Fixtures

Chrome-plated finish, inlet strainer checkstops, volume control, shut-off valve, vacuum breaker, and dial thermometer.	1311575	1–6 gpm	1/2"	20.0 lbs.	\$2,804.00
	1311813	5–14 gpm	1/2"	23.0 lbs.	\$3,067.00

Fotopanel

Stainless steel cabinet includes T/P valve, temperature adjustment, inlet strainer checkstops, On/Off valve, volume control, dial thermometer, vacuum breaker.	4401000	1–6 gpm	1/2"	17.0 lbs.	\$3,273.00
	4403000	5–14 gpm	1/2"	21.0 lbs.	\$4,106.00
Same as 440-1000 with recessed cabinet.	4401020	1–6 gpm	1/2"	17.0 lbs.	\$3,962.00
Optional temperature ranges; add appropriate suffix code.	40° to 90°F	Suffix code: W		Add: \$172.00	
	120° to 175°F	Suffix code: V		Add: \$172.00	

A WATTS Brand



High Temperature Shutoff Device

Type	Order Code	Weight (lbs.)	List Price
—	HT115	0.3	\$69.00

Show high temperature shut-off device used between shower arm and shower head
115°F limit. Automatic reset. ASSE 1062 listed.

Checkstops (sold in pairs)



Type	Order Code	Weight (lbs.)	List Price
Straight, 1/2" IPS, Concealed	A	1.1	\$87.00
Straight, 1/2" IPS, Exposed, Polished Chrome	B	1.0	\$257.00
Straight, 1/2" Sweat, Concealed	C	1.1	\$87.00
Angled, 1/2" Sweat, Concealed	D	1.3	NLA
Angled, with Strainer, 1/2" IPS, Concealed	E	2.5	\$235.00
Angled, with Strainer, 1/2" IPS, Exposed, Polished Chrome	F	2.4	\$367.00
Straight, 1/2" IPS, Rough Chrome	G	1.1	NLA

Showerheads



Type	Order Code	Weight (lbs.)	List Price
Economizer, Chrome-Plated ABS, Adjustable	J	0.5	\$20.00
Standard, Chrome-Plated Brass, Adjustable	K	0.7	\$42.00
Large, Chrome-Plated Brass, Adjustable	M	1.1	\$68.00
Low Flow (1.5 gpm) Shower Head, Chrome-Plated	G	2.5	\$106.00
Low Flow (1.5 gpm) Shower Head, Chrome-Plated	H	0.5	\$84.00
Massage Showerhead, Polished Chrome	—	0.9	NLA
Adjustable, Brass Ball Joint Showerhead, Polished Chrome	—	1.5	NLA
Standard, Chrome-Plated Brass, Adjustable, 1/2" Male Thread	—	0.7	\$64.00
Large, Chrome-Plated Brass, Adjustable, 1/2" Male Thread	—	1.1	\$90.00



Institutional Showerheads

Type	Order Code	Weight (lbs.)	List Price
30° Fixed Head with Screwed/Sweat Connections	—	3.1	NLA
Wall-Mounted, 25°, Fixed Head with 5° Adjustment Feature, Vandal-Resistant.	—	2.0	\$301.00
Fixed Showerhead, Adjustable Spray, Chrome-Plated, Brass	—	1.0	\$200.00
Fixed Showerhead, with Adjustable Spray, Chrome Plated, Brass 1.5 gpm	—	1.0	\$200.00
Small Ball Joint Shower Head with Wall Bracket, Anchor Plate, and Adjustable Spray, Chrome Plated, Brass	—	3.0	\$257.00
Large Ball Joint Shower Head with Wall Bracket, Anchor Plate, and Adjustable Spray, Chrome Plated, Brass	—	3.2	\$282.00
Fixed Showerhead with Wall Bracket, Anchor Plate, and Adjustable Spray, Chrome-Plated, Brass	—	2.7	\$257.00
Fixed Showerhead with Wall Bracket, Anchor Plate, and Adjustable Spray, Chrome Plated, Brass 1.5 gpm	—	2.7	\$282.00

A WATTS Brand



Arm and Flange Kits

Type	Order Code	Weight (lbs)	List Price
Standard Arm and Flange	141 399	0.3	\$31.00
Deluxe Arm and Flange (with set screw on flange)	141 198	0.4	\$48.00







Hand Shower Systems

24" Stainless Steel ADA Wall Grab Bar, Regular Hand Shower, Shower System	—	141 180	4.7	NLA
24" Stainless Steel ADA Wall Grab Bar with Shower System1	141 174	4.7	\$442.00
36" Stainless Steel ADA Wall Grab Bar with Shower System2	141 175	5.5	\$455.00
Deluxe, Metal Hose, 30" Glide Rail3	141 919	3.5	\$517.00
Professional, Vinyl Hose, 30" Glide Rail Bar, Push Button4	141 921	2.7	\$432.00
Standard, Metal Hose, Two Wall Hooks5	141 161	2.0	\$205.00
Deluxe, Metal Hose, 24" Glide Rail6	141 163	3.1	\$432.00
Professional, Vinyl Hose, 24" Glide Rail, Push Button7	141 318	2.3	\$276.00
Standard, Metal Hose, 24" Glide Rail8	141 827	2.3	\$268.00
European, Metal Hose, 23" Wall Bar9	141 918	2.0	NLA
Deluxe, Metal Hose, 18" Glide Rail	—	141 849	3.0	\$591.00
Deluxe, Metal Hose, 48" Wall Bar	—	141 757	4.0	\$631.00
Standard, Metal Hose, 30" Glide RailN	141 879	2.8	\$361.00
Low Flow (1.5g pm) Metal Hose, Two Wall HooksK	141 151	4.8	\$284.00
Low Flow (1.5g pm) Massage Metal Hose, 30" Glide RailL	141 150	5.06	\$475.00
Professional, Metal Hose, 48" Glide Rail	—	141 917	4.3	\$469.00
Professional, Stainless Steel Hose, 24" Glide Rail, Push Button	—	141 912	2.3	\$363.00
Professional, Metal Hose, 24" Glide Rail, Push Button	—	141 851	2.3	NLA
Professional, Vinyl Hose, 18" Glide Rail, Push Button	—	141 837	2.2	\$517.00
Standard, Vinyl Hose, 24" Glide Rail	—	141 828	2.8	\$276.00
Professional, 69" Vinyl Hose, 24" Glide Rail, Push Button	—	141 767	2.3	NLA
Standard, Metal Hose, 24" Glide Rail	—	141 887	2.7	\$308.00
Standard, Metal Hose, 30" Glide Rail	—	141 693	4.0	NLA
Deluxe Hand Shower*	—	141163A	1.0	\$224.50
Hand Shower*	—	141161A	0.5	\$69.30
Hand Shower with Push Button*	—	141318A	0.3	\$75.90
24" Glide Rail*	—	141163D	0.9	\$222.40
30" Glide Rail*	—	141 731	1.7	\$275.50
48" Wall Bar*	—	141 745	2.7	NLA
60" Double Spiral Metal Hose*	—	141161B	1.0	\$115.80
60" Reinforced Vinyl Hose*	—	141318B	0.9	\$102.40
Swivel Connector*	—	141161C	0.3	\$62.40
Pin Style Wall Mount with Screw Mount*	—	141161D	0.2	\$43.40
1/2" Chrome-Plated Elbow with Wall Flange*	—	141 320	1.0	\$60.10
Quick-Release Hose Coupling (Quick Disconnect)	—	141804A	0.4	\$104.00

NOTE: All metal hose are expandable from 60 - 80".

*Parts Discount Applies

A WATTS Brand

Tub Spouts	Q 	R 	S 	T 	U 
Diverter, Chrome-Plated Brass, 3/4" IPS	Q				
Non-Diverter, Chrome-Plated, 1/2" IPS.		R			
Diverter, Chrome-Plated, 1/2" IPS			S		
Diverter, Chrome-Plated Brass, 1/2" IPS				T	
Diverter, Chrome-Plated, 1/2" Slip-fit					U
				141 159	1.2 \$101.00
				141 171	0.4 \$45.00
				141 349	0.7 \$54.00
				141 350	1.3 \$93.00
				141 409	1.0 \$59.00



141600B



141600E



141600F

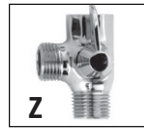

Z

Diverter

Concealed Diverter Valve, 3-Port, 1/2" Sweat, Metal Handle	Y	141600B	2.0	\$222.00
Concealed Diverter Valve, 3-Port, 1/2" Sweat, Deluxe ABS Handle	A	141600E	3.0	\$237.00
Concealed Diverter Valve, 3-Port, 1/2" Sweat, Deluxe Metal Handle	B	141600F	3.0	\$244.00
Exposed Diverter, 3-Port, Shower Arm-Type	Z	141 700	0.5	\$71.00



V



W



043834A

Vacuum Breakers

Wall-Mounted Vacuum Breaker, Chrome-Plated Finish, Elevated	V	131 258	2.0	\$312.00
In-Line Vacuum Breaker	W	141 319	0.4	\$48.00
Vacuum Breaker, 1/2" NPT Outlet, Wall Mount, Polished Chrome	—	131 970	1.8	NLA
Vacuum Breaker, 1/2" NPT Bottom Inlet, 1/2" NPT Side Outlet, Polished Chrome	—	043834A	—	NLA

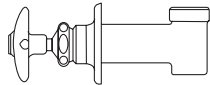

975 170

Volume Control Valves

Concealed, 1/2" IPS		975 170	1.0	\$361.00
Showerhead Volume Regulator*		141 305	0.5	NLA

Dial Thermometers



8943709



8943928



8943897

For mounting with HydroGuard systems:

Flush-mounted Thermometer with 3-Color Dial, Piping Manifold, and Stainless Escutcheon. 0 to 200°F		131 251	2.0	\$488.00
--	--	----------------	-----	----------

Thermometers with Bulb for Liquid Exposure:

3-Color Dial, 1-1/16" Bulb. Scale is 0 to 200°F (-20 to 90°C)		8943709	0.5	\$265.00
3-Color Dial, Horizontal Bulb. Scale is 0 to 200°F (-20 to 90°C)		8943928	1.0	\$276.00
Black Dial, 1-7/8" Bulb. °F Scale. 30 to 130°F.		8943897	1.0	\$265.00
Combination Thermometer, 1/2" T/P Thermometer. 0 to 200 psi, 60 to 320°F		131 123	0.5	\$193.00

Metering Valve

Metering Valve - Shower		141 820	3.6	\$939.00
-----------------------------------	--	----------------	-----	----------

*Parts Discount Applies

A WATTS Brand

To determine the price of a complete #11 Regulator, add the price of the desired lower housing (below) to the price of the desired thermal system (page 37)

595 - -

Lower Housing

Determine the order code from the lower housing assembly code chart (below). Eliminate the 590 prefix when ordering a complete regulator

Thermal system

Determine the order code from the thermal system code chart (page 36). Eliminate the 700 prefix when ordering a complete regulator

#11 Lower Housing Assemblies

590 -

Seat	Packing	Valve Type		Order Code
		Body	Trim	
Single Comp	EP (Heating)	Bronze	Bronze	CD
Single	TFE (H) EP (C)	Bronze	Stainless	ST
Double	EP (H&C)	Bronze	Bronze	DB
Double	TFE (H) EP (C)	Bronze	Stainless	DS
Mixing	EP (Mixing)	Bronze	Bronze	WM

Size	Style					Order Code
	CD	ST	DB	DS	WM	
1/2" A	-	-	-	-	-	A50
1/2" B	-	-	-	-	-	B50
1/2" C	-	-	-	-	-	C50
1/2" D	-	-	-	-	-	D50
1/2"	\$1,194.00	\$1,339.00	-	-	-	50
3/4"	\$1,266.00	\$1,359.00	-	-	\$1,450.00	75
1"	\$1,553.00	\$1,700.00	\$1,980.00	\$2,479.00	\$1,565.00	100
1-1/4"	\$1,807.00	-	\$2,120.00	\$2,412.00	\$1,826.00	125
1-1/2"	\$2,089.00	-	\$2,443.00	\$3,204.00	\$2,106.00	150
2"			\$3,312.00	\$4,337.00	\$2,809.00	200

Pricing: To determine the list price and availability of the selected lower housing, locate the size and style desired in the chart above. The number corresponding to your selection is your list price. If a list price is not shown for your selection, then your selection is not available in the size and style chosen.

Valve Action

Heating (not available in WM body style) H
 Cooling (not available in type CD and WM body style) C
 Mixing (WM only) M

Order Code

Note: These products are made to order and are not returnable or subject to credit.

A WATTS Brand

Bulb and Capillary Material	Price	Order Code
Copper (with 8" capillary)	\$ 1,291.00	C
Stainless Steel (with 8" capillary)	\$ 2,495.00	S

Capillary Length		
8'	N/C	08
15' (copper)	\$ 283.00	15
15' (stainless steel)	\$ 444.00	15
30' (copper)	\$ 404.00	30
30' (stainless steel)	\$ 1,168.00	30

Bulb Style		
Fixed Union	N/C	D
No Pipe Fittings	N/C	J
Adj. Union (N/A in "H" head)	\$ 278.00	A
D Vertical	\$ 193.00	V

• All other bodies		
Non-Indicating	N/C	N
Indicating	\$ 261.00	I

700 -

Range/Bulb Size Code (two-digit codes below)
 All ranges/bulb sizes listed below are **no charge**. Select range with setpoint in **upper third** for best performance. Consult factory for ranges/bulb sizes not listed.

**Temperature Ranges
 Single or Double Seat Valves
 Sizes 1/2" through 2"**

Range/Bulb Size Codes	Heating D.A.	Cooling R.A.	Water Mix 1/2" to 2"
1" x 20" 01	10° to 70°F	0° to 60°F	10° to 60°F
Bulb 02	55° to 115°F	45° to 105°F	55° to 115°F
03	85° to 145°F	70° to 130°F	80° to 140°F
04		90° to 150°F	100° to 160°F
05	110° to 170°F	110° to 150°F	110° to 160°F
06	06 no longer available. Substitute either 05 or 07		
1" x 9" 07	140° to 200°F	120° to 180°F	135° to 195°F
Bulb 08	170° to 230°F	150° to 210°F	160° to 220°F
09	200° to 250°F	180° to 245°F	200° to 250°F
10	230° to 290°F	220° to 280°F	230° to 280°F
11	270° to 330°F	255° to 315°F	260° to 320°F

**Temperature Ranges
 Double Seat
 Valve Sizes 2 -1/2" through 4"**

Range/Bulb Size Codes	Heating D.A.	Cooling R.A.	Water Mix
12	10° to 70°F	0° to 60°F	Not applicable
1-1/4" 13	55° to 115°F	45° to 105°F	
x 24" 14	85° to 145°F	70° to 130°F	
Bulb 44		90° to 150°F	
15	110° to 170°F		
16	16 no longer available. Substitute either 15 or 17		
1" x 20" 17	140° to 200°F	120° to 180°F	Not applicable
Bulb 18	170° to 230°F	150° to 210°F	
19	200° to 250°F	185° to 245°F	
20	230° to 290°F	220° to 280°F	
21	270° to 330°F	225° to 315°F	

#11 Accessories

Wells

Bulb Size	Chrome-Plated Copper		Stainless Steel	
	Part No.	Price	Part No.	Price
1" x 9"	709 193	\$207.00	808 478	\$688.00
1" x 20"	709 075	\$292.00	808 475	\$722.00

Stem Lubricator (not recommended for steam packing)

Part No.	Price
590184A	\$98.00

Note: Thermal systems are made to order (MTO) and are not returnable or subject to credit.

A WATTS Brand

593 –

Valves

- High Performance 2-way **SS**
- Economy 2-way **SD**
- Mixing **WM**
- High Capacity
Balanced 2-way **DB**
- Precision Low Flow **VE**

Size Order Code

- 1/2" (VE only) **A50-D50**
- 1/2" (others)* **050**
- 3/4" **075**
- 1" **100**
- 1 1/4" **125**
- 1 1/2" **150**
- 2" **200**

End Connections

- Screwed **S**

Valve Trim

- Stainless (DB, SS, VE) **S**
- Bronze w/Ep (DB, SD, WM) **B**
- Bronze w/ Teflon (WM) **T**

Action

- Fail Open (Air-to-Close) **X**
- Fail Closed (Air-to-Open) **C**
- Mix **M**

Packing

- Teflon V-Ring **S**
- EP V-Ring **W**

**ACCESSORIES
SELECT CODE**
(refer to next page)

**ACTUATOR
SELECT CODE**
(refer to next page)

*Not available with WM & SD type body.

Note: These products are made to order (MTO) and are not returnable or subject to credit.

A WATTS Brand

Valve Body Prices

SS

Size Code	Body Style/Valve Trim	Price
050	Screwed-NPT, 17-4 SS	\$ 1,133.00
075	Screwed-NPT, 17-4 SS	\$ 1,232.00
100	Screwed-NPT, 17-4 SS	\$ 1,324.00

Size Code	Body Style/Valve Trim	Price
125	Screwed-NPT, 17-4 SS	\$ 1,778.00
150	Screwed-NPT, 17-4 SS	\$ 1,967.00
200	Screwed-NPT, 17-4 SS	\$ 2,981.00

SD

Size Code	Body Style/Valve Trim	Price
075	Screwed-NPT, Bronze	\$ 782.00
100	Screwed-NPT, Bronze	\$ 919.00
125	Screwed-NPT, Bronze	\$ 1,118.00

Size Code	Body Style/Valve Trim	Price
150	Screwed-NPT, Bronze	\$ 1,259.00
200	Screwed-NPT, Bronze	\$ 1,654.00

WM

Size Code	Body Style/Valve Trim	Price
075	Screwed-NPT, Comp. Disc	\$ 918.00
075	Screwed-NPT, Teflon	\$ 918.00
100	Screwed-NPT, Comp. Disc	\$ 918.00
100	Screwed-NPT, Teflon	\$ 918.00
125	Screwed-NPT, Comp. Disc	\$ 1,161.00

Size Code	Body Style/Valve Trim	Price
125	Screwed-NPT, Teflon	\$ 1,161.00
150	Screwed-NPT, Comp. Disc	\$ 1,302.00
150	Screwed-NPT, Teflon	\$ 1,302.00
200	Screwed-NPT, Comp. Disc	\$ 1,716.00
200	Screwed-NPT, Teflon	\$ 1,716.00

DB

Size Code	Body Style/Valve Trim	Price
100	Screwed-NPT, Bronze	\$ 1,556.00
100	Screwed-NPT, 316 SS	\$ 2,049.00
125	Screwed-NPT, Bronze	\$ 1,736.00
125	Screwed-NPT, 316 SS	\$ 2,608.00

Size Code	Body Style/Valve Trim	Price
150	Screwed-NPT, Bronze	\$ 2,094.00
150	Screwed-NPT, 316 SS	\$ 2,940.00
200	Screwed-NPT, Bronze	\$ 3,126.00
200	Screwed-NPT, 316 SS	\$ 4,473.00

VE

Size Code	Body Style/Valve Trim	Price
A-D50	Screwed-NPT, 300/400 SS	\$ 1,124.00

Actuator Select Code

CODE	PNEUMATIC DIAPHRAGM ACTUATORS	PRICE
46	46 Sq. In. 1" Max Valve Stroke w/Standard Springs adjustable start w/6-12 lb. Fixed Span	\$ 819.00
4X	46 Sq. In. 1" Max Valve Stroke w/Extended Springs (Requires Positioner), adjustable start w/22 lb. Span	\$ 1,124.00
4C	46 Sq. In. 1" Max Valve Stroke Extreme Cycle Springs adjustable start w/6-12 lb. Fixed Span	\$ 1,124.00

Accessories Select Code

CODE	DESCRIPTION	PRICE
	Bellofram 1000 I/P'S	
IS	3-15 psi	\$ 1,945.00
TS	1-17 psi	\$ 1,945.00
US	3-27 psi	\$ 1,945.00
	CONTROL/AIR TYPE 900X I/P	
ES	0-30 psi	\$ 2,507.00
	UTILITY POSITIONER AND I/P	
BS	4-20 mA	\$ 3,248.00
	UTILITY POSITIONER	
PS	3-15 psi	\$ 1,663.00
RS	3-9 psi	\$ 1,663.00
SS	9-15 psi	\$ 1,663.00
	NO ACCESSORIES	
OS	No Accessories	N/C

Note: These products are made to order (MTO) and are not returnable or subject to credit.

A WATTS Brand

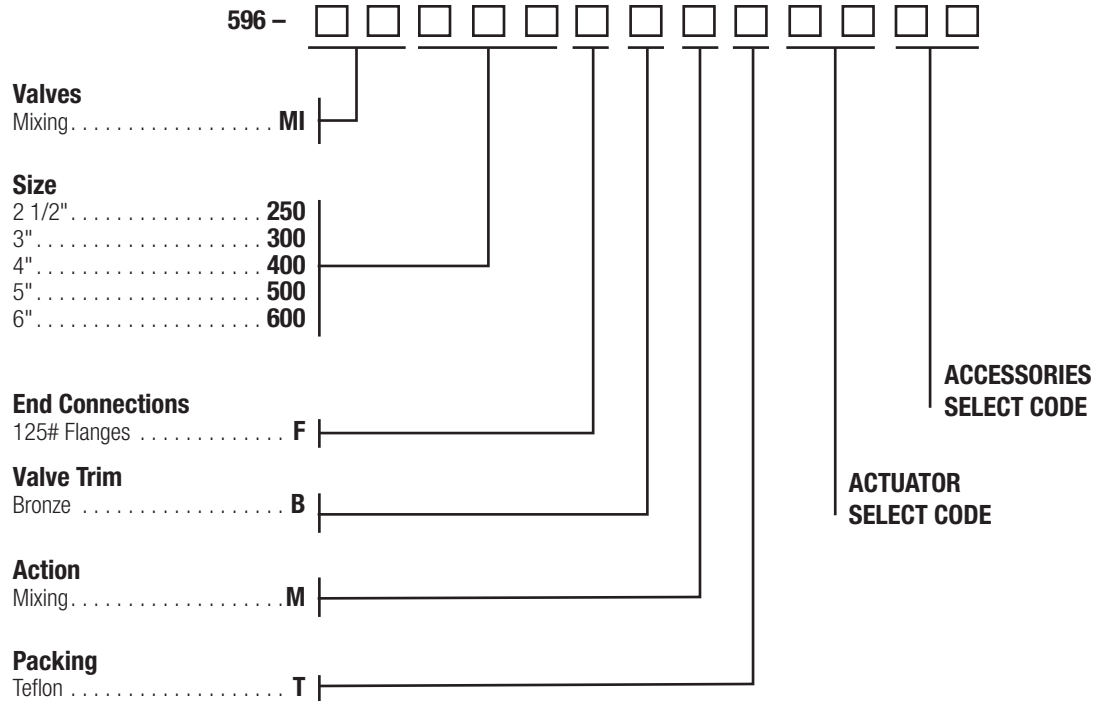

Actuator Compatibility

2-1/2", 3", 4"	46" and 100" Diaphragm
5", 6"	100" Diaphragm

Valve Body Prices

MI

Size Code	Body Style/Valve Trim	Price
250	125 lb. Flanges, Bronze	\$ 2,864.00
300	125 lb. Flanges, Bronze	\$ 3,408.00
400	125 lb. Flanges, Bronze	\$ 4,883.00
500	125 lb. Flanges, Bronze	\$ 7,030.00
600	125 lb. Flanges, Bronze	\$ 8,138.00

Actuator Select Code

CODE	PNEUMATIC DIAPHRAGM ACTUATORS	PRICE
46*	46 Sq. In. 1" Max. Valve Stroke Stainless Steel Springs adjustable start w/6-12 lb. Fixed Span	\$819.00
4X*	46 Sq. In. 1" Max. Valve Stroke w/Extended Stainless Steel Springs (Requires Positioner), adjustable start w/22 lb. Span	\$1,124.00
1M	100 Sq. In; 5-10 psi Spring Range, (Mixing Valves)	\$2,731.00

***Not Available with 5" or 6" valve**

Accessories Select Code

CODE	DESCRIPTION	PRICE
	Bellofram 1000 I/P'S	
IS	3-15 psi	\$ 1,945.00
TS	1-17 psi	\$ 1,945.00
US	3-27 psi	\$ 1,945.00
	CONTROL/AIR TYPE 900X I/P	
ES	0-30 psi	\$ 2,507.00
	UTILITY POSITIONER AND I/P	
BS	4-20 mA	\$3,248.00
	UTILITY POSITIONER	
PS	3-15 psi	\$ 1,663.00
RS	3-9 psi	\$ 1,663.00
SS	9-15 ps	\$ 1,663.00
	NO ACCESSORIES	
OS	No Accessories	N/C

Note: These products are made to order (MTO) and are not returnable or subject to credit.

A WATTS Brand

597 –

Valves

2-Way..... **SI**

Size

2 1/2"..... **250**
 3"..... **300**
 4"..... **400**
 5"..... **500**
 6"..... **600**

End Connections

125# Flanges **F**

Valve Trim

Bronze **B**

Action

Fail Open (Air-to-Close) **X**

Fail Closed (Air-to-Open) **C**

Packing

Teflon **T**

**ACCESSORIES
SELECT CODE**

**ACTUATOR
SELECT CODE**

Valve Body Prices

SI	Size Code	Body Style/Valve Trim	Price
	250	125 lb. Flanges, Bronze	\$ 2,864.00
	300	125 lb. Flanges, Bronze	\$ 3,408.00
	400	125 lb. Flanges, Bronze	\$ 4,883.00
	500	125 lb. Flanges, Bronze	\$ 7,030.00
	600	125 lb. Flanges, Bronze	\$ 8,138.00

Actuator Select Code

CODE	PNEUMATIC DIAPHRAGM ACTUATORS
4C	46 Sq. In., 1" Max Valve Stroke Extreme Cycle Springs, adjustable start w/6-12 lb. fixed span. \$819.00
1U (for 6" valve only)	100 Sq. In; 8-13 psi Spring Range, (Normally Closed Valves) \$2,731.00
1L (for 6" valve only)	100 Sq. In; 3-8 psi Spring Range, (Normally Open Valves) \$2,731.00

Accessories Select Code

CODE	DESCRIPTION	PRICE
	Bellofram 1000 I/P'S	
IS	3-15 psi	\$ 1,945.00
TS	1-17 psi	\$ 1,945.00
US	3-27 psi	\$ 1,945.00
	CONTROL/AIR TYPE 900X I/P	
ES	0-30 psi	\$ 2,507.00
	UTILITY POSITIONER AND I/P	
BS	4-20 mA	\$3,248.00
	UTILITY POSITIONER	
PS	3-15 psi	\$ 1,663.00
RS	3-9 psi	\$ 1,663.00
SS	9-15 ps	\$ 1,663.00
	NO ACCESSORIES	
OS	No Accessories	N/C

Note: These products are made to order (MTO) and are not returnable or subject to credit.

A **WATTS** Brand
Unmounted Valve Accessories

PRODUCT NUMBER	DESCRIPTION	PRICE
UTILITY GRADE PNEUMATIC POSITIONERS		
1473000D	1/8" - 3/16" Stroke Full Range	\$ 1,845.00
1473000C	1/4" - 3/8" Stroke Full Range	\$ 1,845.00
1473000	1/2" - 3/4" Stroke Full Range	\$ 1,845.00
1473000A	1" - 1 1/2" Stroke Full Range	\$ 1,845.00
1473000C	1/8" - 3/16" Stroke Split Range	\$ 1,845.00
1473000	1/4" - 3/8" Stroke Split Range	\$ 1,845.00
1473000A	1/2" - 1" Stroke Split Range	\$ 1,845.00
1420373	Positioner Output Pressure Gauge	\$ 64.00
POSITIONER MTG. KIT		
147301E	46" Act., Fail Open, 1/4" Stem	\$ 117.00
147302E	46" Act., Fail Close, 1/4" Stem	\$ 117.00
147301G	46" Act., 1/2" Stem	\$ 117.00
147301H	100" Act., 1/2" Stem	\$ 117.00

PRODUCT NUMBER	DESCRIPTION	PRICE
UTILITY MTG. KIT I/P & POSITIONER		
593002E	46" Act., Fail Open, 1/4" Stem	\$ 391.00
593003E	46" Act., Fail Close, 1/4" Stem	\$ 391.00
593002G	46" Act., 1/2" Stem	\$ 391.00
593002H	100" Act., 1/2" Stem	\$ 391.00
UTILITY I/P MTG. KIT		
512118E	46" Act., Fail Open, (Dir.Act.)	\$ 255.00
512119E	46" Act., Fail Close (Rev.Act.)	\$ 255.00
590184A	Stem Lubricator (Type "W" Packing Only)	\$ 98.00
512118H	100" Act.	\$ 255.00
BELLOFRAM 1000 I/P'S		
512 015	3-15 I/P Transducer	\$ 1,288.00
512 117	1-17 I/P Transducer	\$ 1,288.00
512 027	3-27 I/P Transducer	\$ 1,288.00
CONTROL/AIR TYPE 900X I/P		
100 127	0-30 psi with Mounting Kit, 46" Act.	\$ 2,111.00
100127H	0-30 psi with Mounting Kit, 100" Act.	\$ 2,172.00

A WATTS Brand

Accritem® Temperature Controller

Adjustable setpoint, 50° to 350°F.

Complete with pressure gauges and fittings.

Rigid Copper Bulb (1/2" NPT Pipe Fitting)

Model	Action	Order Code	Weight (in lbs.)	List Price
Air Operated	Direct	7441213	3	\$ 1,171.00
	Reverse	7441214	3	\$ 1,171.00
Water Operated	Direct	7441217	4	\$ 1,770.00
	Reverse	7441218	4	\$ 1,770.00

Rigid Stainless Bulb (1/2" NPT Pipe Fitting)

Model	Action	Order Code	Weight (in lbs.)	List Price
Air Operated	Direct	7441270	4	\$ 1,636.00
	Reverse	7441271	4	\$ 1,636.00

Accritem® Accessories

Description	Order Code	Weight (in lbs.)	List Price
Accessory Kit for Air or Gas	744 107	2	\$ 640.00
Accessory Kit for Water	744 180	1	NLA
Union Fitting—Brass	744 106	1	\$ 135.00
Socket Well—Copper	744 111	1	\$ 301.00
Socket Well—Stainless Steel	744 082	1	\$ 725.00
Valve and Seat Repair Kit	744 168	1	\$ 90.00

Accritem® II Temperature Controller

Adjustable setpoint, dual scale: 0° to 300°F and 20° to 150°C.

Complete with pressure gauges and fittings.

Remote Copper Bulb (3/8" x 4" bulb, 4 ft. capillary) Includes 3/8" NPT Compression Fitting

Model	Action	Order Code	Weight (in lbs.)	List Price
Air Operated	Direct	7441256	2	\$ 1,302.00
	Reverse	7441258	2	\$ 1,302.00

Remote Stainless Bulb (3/8" x 4" Bulb, 10 ft. capillary) Includes 3/8" NPT Compression Fitting

Model	Action	Order Code	Weight (in lbs.)	List Price
Air Operated	Direct	7441272	2	\$ 1,819.00
	Reverse	7441273	2	\$ 1,819.00

Accritem® II Accessories

Description	Order Code	Weight (in lbs.)	List Price
Accessory Kit for Air or Gas	744 107	2.0	\$ 640.00
Socket Well—Copper	184 119	0.4	\$ 176.00
Socket Well—Stainless	184 118	0.4	NLA

A WATTS Brand

Part No.	Description	List Price	Part No.	Description	List Price
006 379	COPPER TUBING	\$4.70	041 100	NUT, HEX BRS.	\$5.30
030 041	FIL HD BR SCREW	\$4.70	041 119	1/4- 32 X 1/8 X 3/8 HEX NUT	\$5.30
030 061	SCREW, BRASS 8-32 X 3/16"	\$5.30	041 121	NUT 1-1/4 X 20 X 3/16 X 7/16	\$5.30
030 066	SCREW, FIL HD BR	\$5.30	041 125	HEX BRS NUT	\$4.70
030 068	FIL HD BR SCREW	\$4.70	041 127	NUT, LOCK 1/4-28 BR.CHR.PLATE	\$5.30
030 070	FIL HD BR SCREW	\$5.30	041 142	HEX BRS NUT	\$4.70
030 104	SCREW FIL HD BR	\$5.30	041 226	NUT 3/8-16 BRASS OR ST. STL.	\$4.70
030 106	SCREW	\$4.70	041121G	HEX STL NUT	NLA
030 109	FIL HD BR SCREW	\$4.70	041167J	SCREW	\$5.30
030 126	FIL HD BR SCREW	\$4.70	041225K	NUT, SHAKEPROOF 5/16-18	\$4.70
030 211	10-32 X 3/8" SCREW	\$4.70	042 672	BRASS NIPPLE 1/2"	\$15.40
030 884	SCREW, ADJ. STOP 10-32 X 5/16"	\$4.70	042 786	3/4" X 6" BRASS NIPPLE	\$51.00
030 885	SCREW FOR BONNET 10-32 X 1"	\$4.70	042 900	1-1/4" NPT X 6" LG BRASS NIPPLE	\$73.50
030 887	SCREW 10-24 X 9/16" LENGTH	\$5.30	042672A	NIPPLE	\$23.90
030 889	SCREW	\$4.70	042672G	NIPPLE, 1-1/8" X 1/2"	\$20.10
030 890	SCREW 10-24 X 3/4" LENGTH	\$5.30	042676G	NIPPLE (420-100)	\$20.10
030 895	SCREW	\$5.30	043 001	THREAD, PROTECTOR 1/8 I.P.S.	NLA
030061G	SCREW, POLISHED CHR 8-32 X 3/16"	\$4.70	043 202	BUSHING, PIPE 1/4" X 1/8"	NLA
030068G	FIL HD BR SCREW	\$4.70	043 337	PIPE PLUG, 1-1/4" BRASS	\$69.10
030109G	FIL HD BR SCREW	\$4.70	043 339	PIPE PLUG, 1-1/2" BRASS	\$75.90
030126BP	PHILLIPS HEAD BRASS SCREW, QTY= 25	\$33.40	043 342	PIPE PLUG, 2" BRASS	\$153.50
030542J	SCREW	\$5.30	043 351	1/8" FEMALE BRASS PIPE TEE	\$22.00
030546J	SCREW	\$5.30	043 868	1-1/4" NPT BRASS COUPLING	\$78.20
030550J	SCREW, 5/16-18 X 1-1/4"	\$5.30	043 869	COUPLING 3/4" BRASS	\$20.10
030884BP	SCREW, STAINLESS-BULK 50/KIT	\$45.20	043009C	THREAD PROTECTOR	\$5.30
030885BP	SCREW, STAINLESS-BULK 50/KIT	\$67.62	043221G	REDUCING BUSHING	\$28.70
030887BP	SCREW. QTY= 25	\$18.50	043331A	TEE PLUG	\$34.00
030887JP	SCREW, QTY= 500	\$211.90	043401A	PIPE-TEE 1/2" POLISHED CHROME	\$56.00
030889BP	SCREW- BULK 50/KIT	\$69.30	043419A	3/4" THERM TEE ACCORN	\$98.10
032 064	SCREW - BRASS	NLA	043576G	ELBOW (420-100)	\$47.10
032 071	FL HD BR SCREW	\$4.70	043810A	ESCUTCHEON PLATE	\$5.30
032 072	FL HD BR SCREW	\$4.70	043819A	PIPE STRAP, POLISHED CHROME	\$91.40
032465A	SCREW, 3/8-24 X 1/2" LG.	\$11.80	043821A	3/4" PIPE STRAP POLISHED CHR.	\$91.40
034 234	SCREW	\$5.30	043826A	1-1/4" PIPE STRAP POLISHED CHR	\$97.30
034 364	SCREW	\$5.30	044 045	ELBOW, STREET 90 DEGREE	\$5.90
034 377	SCREW, SET 10-32 X 3/8" STEEL	\$4.70	044 227	COUPLING 1/2" FEMALE	\$53.60
034 407	SCREW	\$5.30	046 145	WASHER 463 X 140	\$5.30
034 413	SCREW 8-32 X 3/16"	\$5.30	046007K	LOCKWASHER, SHAKEPROOF	\$5.30
034 432	SET SCREW	\$5.30	046008K	WASHER, SHAKEPROOF STEEL	\$5.30
034047G	SCREW, 6-32 X 5/16"-SERIES 460	\$5.30	046011J	WASHER, SHAKEPROOF	\$4.70
034221G	OVAL PH HD SCREW	\$5.30	046017BP	LOCK WASHER, QTY= 25	\$21.30
034223G	PHILLIPS HEAD SCREW	\$5.30	046164K	WASHER	\$5.30
034224G	SCREW 8-32 X 1-1/4" LG	\$5.30	047 002	O-RING	\$5.30
034413BP	SCREW, 8-32 x 3/16" QTY= 25	\$29.60	047 007	QUAD RING 1/4 X 3/8 X 1/16	\$4.70
034510G	SCREW	\$5.30	047 008	O-RING 5/16 X 7/16 X 1/16	\$5.30
034512K	SCREW, 8-32 X 1-1/4"	\$4.70	047 010	O-RING	\$5.30
034515K	SCREW, 8-32 X 1/2" LG.	\$4.70	047 013	QUAD-RING 3/8 X 1/2 X 1/16	\$5.30
035 316	SQ HD SET SCREW	\$5.30	047 015	O-RING 11/16 X 7/8 X 3/32	\$5.30
041 080	HEX BRS NUT	NLA	047 020	RING	\$5.30
041 092	HEX BRS NUT	\$5.30	047 022	RING	\$5.30

A WATTS Brand

Part No.	Description	List Price
047 025	O-RING 1-3/8 X 1-5/8 X 1/8	\$5.30
047 029	RING	\$5.30
047 031	RING	\$5.30
047 033	O-RING 1/2 X 5/8 X 1/16	\$5.30
047 034	O-RING 5/16 X 7/16 X 1/16	\$5.30
047 035	O-RING 2 X 2-1/4 X 1/8	\$5.30
047 036	RING	\$5.30
047 040	O-RING 3-3/8 X 3-5/8 X 1/8	\$5.30
047 043	QUAD RING 1/8 X 1/4 X 1/16	\$5.30
047 045	O-RING 1/4 X 3/8 X 1/16	\$5.30
047 047	RING	\$5.30
047 049	RING	\$5.00
047 108	O-RING	\$5.00
047 114	O-RING 3/4 X 7/8 X 1/16	\$5.30
047 120	O-RING 7/8 X 1 X 1/16	\$5.30
047 125	QUAD RING	\$5.30
047 126	QUAD RING 3/8 X 1/2 X 1/16	\$5.30
047 128	O-RING 2-1/8 X 2-1/4 X 1/16	\$5.30
047 129	O-RING	\$5.30
047 130	O-RING 2-1/2 X 2-5/8 X 1/16	\$5.30
047 131	O-RING 1-3/16 X 1-5/16 X 1/16	\$5.30
047 132	O-RING 1-7/8 X 2 X 1/16	\$5.30
047002BP	O-RING, QTY= 25	\$19.80
047013BP	O-RING, QTY= 25	\$25.50
047015BP	O-RING, QTY= 25	\$19.30
047020JP	O-RING KIT QTY=. 500	\$87.90
047022BP	RING QTY= 25	\$38.30
047029BP	O-RING, QTY= 25	\$41.90
047029JP	O-RING, JUMBO QTY= 500	\$256.90
047031BP	O-RING, QTY= 25	NLA
047031JP	O-RING, JUMBO, QTY= 500	\$119.00
047035BP	O-RING, QTY= 25	\$43.80
047040BP	O-RING, QTY= 25	\$81.10
047125BP	O-RING, QTY= 25	\$66.80
047126BP	QUAD RING-BULK, QTY= 25, KIT	\$76.40
047126JP	QUAD RING, QTY= 500	\$760.50
047128BP	O-RING- BULK ,QTY= 5, KIT	\$60.10
047130BP	O-RING, QTY= 25	\$28.10
080 008	SCREW 8-32 X 2-1/4 BRASS	\$5.30
080 009	SCREW	\$5.30
080 010	SCREW 8-32 X 2-3/4	\$4.70
080 011	SCREW 8-32 X 2"	\$5.30
080 013	SCREW 8-32 X 1 BRASS FLAT HEAD	\$5.30
080 014	SCREW 1/4-20 X 1/2 ST. STL.	\$5.30
080 015	SCREW 5/16-18 X 3/4 ST. STL.	\$5.30
080 026	SCREW 8-32 X 3-1/2 POL. CHR. PL.	\$5.30
080 029	SCREW,10-32 FLAT HEAD	\$5.30
080 032	SCREW 1/4"-20 X 5/8" LG	\$5.30
080 033	SCREW	NLA
080 034	SCREW 1/4 X 20 X1 STAINLESS	\$4.70
080 037	SCREW, TRIM PLATE	\$5.30

Part No.	Description	List Price
080 041	SCREW 8/32, 1-1/4" LONG	\$5.30
080 042	SCREW 8/32 X 3 1/2 V/PROOF	\$10.10
080 053	6-32 X 1/4 LG ST STL SCREW	\$5.30
080 058	10-32 X 5/8 SCREW	\$4.70
080 064	SCREW, 6 X 1/4" PAN HD,SELF TAP	\$5.30
080 072	SCREW 10-32 X 2" LG	\$5.30
080 076	SET SCREW	\$4.70
080008BP	FLAT HEAD SCREW (25 EACH)	\$73.90
080010BP	SCREW, 8-32 X 2-3/4, QTY= 25	\$40.30
080011BP	SCREW, QTY= 25	\$41.90
080013BP	SCREW, QTY= 25	NLA
080022A	SCREW	\$5.30
080026BP	SCREW, QTY= 25	\$88.00
080042A	V/P SCREW, 8 32 X 3/4	\$5.30
081 003	NUT, TINNERMAN STUD	NLA
081 008	NUT, 5/16 18 X 19/64 X 9/16	\$4.70
081 010	NUT 10/32 X 3/32 X 5/16	\$4.70
082 005	WASHER 1" OD	\$5.30
082005R	WASHER	\$5.30
084 004	O-RING	\$5.30
084 007	O-RING 1 3/8 X 1 1/2 X 1/16	\$5.30
084 008	O-RING 2 X 2 3/16 X 3/32	\$5.30
084 009	O-RING 2 9/16 X 2 3/4 X 3/32	\$5.30
084 010	O-RING 3 1/4 X 3 1/2 X 1/8	\$5.30
084 014	O-RING 5/8 X 3/4 X 1/16	\$5.30
084 015	O-RING	\$5.30
084 016	O-RING, SILICONE	\$5.30
084 020	O-RING	\$5.30
084 027	O-RING #014	\$5.30
084 029	O-RING	\$5.30
084 030	O-RING	\$5.30
084 031	O-RING	\$5.30
084 032	O-RING	\$6.60
084 033	O-RING	\$5.30
084 041	O-RING	\$5.30
084 042	O-RING	\$5.30
084 045	O-RING	\$5.00
084011JP	O-RING, JUMBO QTY= 500	\$481.60
084014BP	O-RING, QTY= 25	\$35.10
084023BP	OVERSIZE O-RING / QTY=.25 PCS	\$73.90
084025BP	O-RING, QTY= 25	\$30.40
084032BP	O-RING, QTY= 25	\$114.20
084033BP	O-RING, QTY= 25	\$114.20
087 126	SILICONE GEL CHEMPLEX 825	\$5.30
087126JP	SILICONE GEL, QTY= 500	\$427.00
084014BP	O-RING, QTY= 25	\$35.10
088 092	INSERTS, ROUGH IN	\$17.50
088 093	ROUGH IN, BOTTOM PAD	\$14.40
088 200	SET SCREW, 10 32 X .25 SS	\$5.30
089 003	WRENCH 3/32" SERVICE CR STL	\$5.30
089 004	WRENCH	\$5.30

A WATTS Brand

Part No.	Description	List Price
0S13738	1/2" STEM EXT & DISC ASSY	NLA
0S13739	1/2" TEFLON DISC	NLA
0S19383	1" STEM EXT & DISK HOLDER ASSY	\$259.00
100 124	C WASHER SPRING TEMPER	\$5.30
100 140	WASHER .031 TH'K BRASS	\$5.30
100034A	WASHER BRIGHT NICKEL PLATE	\$5.30
105 058	HANDLE KIT 4"	\$19.50
105 059	HANDLE KIT 6"	\$38.80
105 060	CARTRIDGE KIT	\$109.70
105 061	BASE PLATE	\$38.80
105 062	BASE PLATE	\$51.70
105 064	SUPPLY TUBES	\$51.70
105 065	AERATOR 2 GPM	\$6.60
105 068	AERATOR 2 GPM	\$6.60
115 072	VALVE BODY	\$174.10
121 061	SPRING, COMPRESSION 10" TOP	\$171.20
131 257	ESCUTCHEON, POLISHED	\$272.50
131 275	ILL. LOCK W/KEYS F/CABINETS FRO	\$153.50
131274A	KEY REPLACEMENT	\$26.30
132 692	VALVE, 1/2" POLISHED CHROME BALL	\$113.40
132320A	TRANSFORMER & TIMER ASSY.	\$2,024.90
132692A	3/4" BALL POLISH	\$171.20
132692B	1" POLISH CHROME BALL VALVE	\$198.00
132692C	1-1/4" BALL VALVE	\$266.40
132692M	BALL VALVE, 1" RB	\$124.90
141 000	KIT, 1/2" CHECKSTOP	\$65.90
141000A	KIT, 1/2" CHECKSTOP, PC	\$77.20
141001BP	SOFT PART & PLUNGER	\$233.70
141 005	SLIDING PIECE FOR #9 HANDSHOWER	\$26.50
141 006	SLIDING PIECE FOR #1 and #2 HANDSHOWER	\$51.40
141 305	FLOW CONTROL, ADJUSTABLE	NLA
141 313	FLANGE FOR 141 198 POL. CHROME	\$18.90
141 320	ELBOW W/FLANGE	\$60.10
141 333	PACKING NUT KIT 1/2" NPT	NLA
141 495	WASHER FOR HANDSHOWER	\$5.30
141 620	HANDLE KIT, INLINE DIVERter	\$23.50
141 621	STEM KIT INLINE DIVERter	\$42.70
141 622	TRIM KIT, INLINE DIVERter	\$69.30
141 651	CHECKSTOP ASSEMBLY	\$8.40
141 741	HANDLE REPAIR KIT, IN LINE DIV	\$29.10
141 808	END CAP & PIN (SINGLE)	\$29.90
141 809	SHOWER MTD W/SPRING (141 163)	\$44.50
141 831	TIMER, SSAC INC SINGLE SHOT	\$630.30
141 832	ILLINOIS LOCK W/2 KEY	\$169.20
141 833	PUSHBUTTON SWITCH W/SCREW CON	\$115.80
141 839	CARTRIDGE ASSY METERING VALVE	\$417.60
141 843	RING, THERMOMETER	\$12.30
141 907	STAND OFF	\$5.30
141166A	HOSE ASSY 18' W/SHAMPOO HEAD	\$673.00

Part No.	Description	List Price
141326B	1/2" ANGLE CHECK (S.J.)	\$70.50
141381E	SCREW	NLA
141381F	SCREW (PKG OF 12)	\$28.40
141381G	WHITE INSERT	NLA
141382A	SHOWERHEAD KIT	NLA
141600A	TRIM KIT INLINE DIVERter	NLA
141612B	INSERT, GRAPHIC	\$30.40
141741A	COLLAR REPAIR KIT DIVERter VLV	\$95.70
141741C	PACKING REPAIR KIT DIVERT VLV.	NLA
141831A	TIMER SOCKET	\$66.80
141901N	SHOWERHEAD KIT	\$202.30
1420229	GAUGE, RECEIVER 1 1/2	\$135.70
1420373	POS. OUTPUT PRESSURE GAUGE	\$64.00
1420431	PRESSURE GAUGE	\$53.60
145 449	PLUG BUTTON ACRYLIC KNOB	\$5.30
145251A	PLUG BUTTON KITCHEN	\$7.20
147 115	SPRING KIT (UP TO 3/4" TRAVEL)	NLA
147 122	TAKE OFF PLATE ST. STL. 46"	\$13.20
147 290	SPRING, 438 O.D. 1.34 LG	NLA
147 291	FEEDBACK SPRING (1" STROKE)	\$5.30
147 330	MOUNTING KIT	NLA
147330C	MOUNTING KIT	NLA
200 046	PIPE PLUG, 1/2" BRASS	\$13.10
200046G	PLUG 1/2" BRASS CHROME PLATE	\$17.10
220 050	METAL HANDLE KIT	\$47.20
220 051	METAL TRIM PLATE	\$75.30
220 052	ABS HANDLE KIT	\$41.40
220 053	ABS TRIM KIT	\$66.00
220 054	SLEEVE KIT	\$33.50
220 060	CARTRIDGE KIT	\$92.20
220 451	METAL UPGRADE KIT	\$186.10
220 452	ABS UPGRADE KIT	\$167.10
220 453	FLAT METAL UPGRADE KIT	\$221.00
225 047	GASKET	\$5.30
225 073	SPRING, VALVE	\$5.30
225 075	DISC, VALVE	NLA
225 253	LIMIT SCREW	NLA
225 349	KEY	\$5.30
225 350	H. CY. WRENCH KIT	\$211.30
225 357	GASKET & PACKING KIT	NLA
225 377	VALVE ASSEMBLY 5 GAL	NLA
225 378	10 GALLON VALVE ASSEMBLY	NLA
225 379	VALVE ASSEMBLY KIT 15 GAL	NLA
225 380	OVERLOAD SPRING ASSEMBLY	NLA
225 386	PISTON CYLINDER	\$69.30
225 387	PISTON CYLINDER	\$69.30
225 388	PISTON CYLINDER	\$69.30
225 389	RETURN SPRING	NLA
225 392	H CYLINDER & VALVE RPLCMT KIT	NLA

A WATTS Brand

Part No.	Description	List Price
225 393	H CYLINDER & VALVE RPLCMNT M3	NLA
225 398	MIXER PISTON 5 & 10 GAL	\$22.60
225 399	MIXER PISTON	\$29.90
225 404	HUVA CUP MODEL 8	\$5.30
225 432	DISC HOLDER	\$11.80
225 433	DISK HOLDER	\$14.50
225 444	BODY 1/2" ROUGH BRZ	\$311.70
225 445	BODY, BRIGHT CHROME 1/2"	\$312.40
225 450	PACKING GLAND 427/428	\$44.40
225050BP	PACKING RING, QTY= 25	\$244.20
225075BP	VALVE DISC, QTY= 25	NLA
225078BP	RETAINER RING, QTY= 25	\$29.60
225152G	MIXER HANDLE	NLA
225238G	ADJUSTMENT STEM	NLA
225257A	SCREW, RETAINING HANDLE	\$5.60
225261A	MIXER CVR	\$75.90
225282A	COVER, MIXER FOR 4401510	NLA
225294A	LOCK RING	\$36.40
225404BP	HUVA CUP, QTY= 25	\$99.60
225404JP	HUVA CUP, QTY= 250	\$838.30
225419N	BONNET, MIXER	NLA
227 063	HOT WATER DISC	NLA
227 109	RETURN SPRING	NLA
227 164	PLUG BUTTON	\$5.90
227 166	RETAINER (DIAL INSERT)	\$18.50
227 188	PACKING GLAND	NLA
227 196	SLEEVE	\$17.50
227 197	WASHER	\$5.30
227 206	SHUT OFF DISC	NLA
227 214	STEM EXT KIT	\$62.20
227 233	SPACER RING	NLA
227 234	ADJUSTMENT STEM MODEL 4 5 6	NLA
227 280	GASKET	NLA
227 291	HOT WTR SEAT ASY	NLA
227 354	CONTROL KNOB	\$19.60
227 388	COMBINATION SEAT ASSEMBLY	NLA
227 389	HOT WTR SEAT ASSY	NLA
227166BP	RETAINER RING, QTY= 15	\$240.30
227166JP	RETAINER RING, QTY= 50	\$678.80
227189BP	TEMPERATURE STOP, QTY= 25	NLA
227190BP	SPACER, QTY= 25	\$34.70
227191S	HANDLE SATIN	NLA
227192JP	RETAINER RING, QTY= 500	\$1,014.00
227233JP	RETAINER RING, QTY= 250	\$682.50
227280BP	GASKET 25 PCS TO KIT	\$18.80
227291BP	HOT WATER SEAT ASSEM. QTY= 15	NLA
227354A	CONTROL KNOB PLASTIC	\$29.90
227354JP	CONTROL KNOB, QTY= 50	\$526.60
230 042	CHECK STOP L.H.	\$184.20

Part No.	Description	List Price
230 045	CHECKSTOP	\$184.20
230 065	GASKET 1 9/16 X 1/32 THK	\$5.30
230 079	STEM	\$21.40
230 081	STEM	\$21.40
230 083	GASKET	\$5.30
230 084	SCREEN	\$5.30
230 094	UNION TAIL PIECE	\$86.90
230 103	POPPET SPRING	\$5.30
230 104	SCREEN	\$15.90
230 116	SCREEN	\$11.90
230 117	UNION NUT	\$34.50
230 119	UNION TAIL PIECE	NLA
230 123	POPPET SPRING	\$5.30
230 127	POPPET SPRING	\$5.30
230 129	1/2" TRIPLE DUTY P	\$41.40
230 130	1/2" TRIPLE DUTY S	NLA
230 131	1/2" TRIPLE DUTY G	\$28.70
230 132	TRIPLE DUTY POPPET K	\$62.20
230 134	3/4" TRI DUTY SCREEN	\$62.20
230 135	3/4" TRIP DUTY POP	\$62.20
230 136	1-1/4" TRI DUTY SCR N	\$93.60
230 137	1-1/4" TRI DUTY POPPET	\$93.60
230 146	CHECKSTOP ASSY RH	NLA
230 147	VOLUME STEM	\$27.30
230 186	POPPET	\$17.10
230 193	RT HND CHECK BODY ROUGH BRONZE	\$71.40
230 223	VOLUME STEM EXTENSION	\$38.60
230 261	CHECK STOP ASSEMBLY	\$161.00
230 262	CHECK STOP ASSEMBLY	\$151.00
230 268	BONNET POLISH CHROME	NLA
230 269	3/4" STEM PLAIN	\$43.40
230 270	3/4" STEM POLISH CHROME	NLA
230 271	3/4" POPPET ASSEMBLY	\$16.40
230 281	CHECK STOP ASSEMBLY	\$165.20
230 287	BONNET	NLA
230 288	BONNET POLISH CHROME	NLA
230 289	STEM ASSEMBLY	\$68.60
230 293	1-1/4" POPPET ASSEMBLY	\$38.30
230 325	1/2" T.D.CHECK STOP ASSY	\$207.00
230011G	STRAINER CAP ASSEMBLY	\$60.40
230067BP	GASKET, QTY= 25	\$130.70
230076A	BONNET	\$29.80
230078A	BONNET	\$38.40
230083BP	GASKET, QTY= 25	NLA
230101BP	GASKET, QTY= 25	\$41.90
230103BP	SPRING, QTY= 25	\$76.40
230104BP	SCREEN, QTY= 15	\$217.70
230261M	3/4" ROUGH BRONZE CHECK STOP	\$287.60
230262G	CHECK STOP	\$325.00

A WATTS Brand

Part No.	Description	List Price	Part No.	Description	List Price
230271JP	POPPET ASSEMBLY, QTY= 50	\$606.30	390 255	ADJUSTMENT KNOB RETAINER	\$24.70
230281M	1-1/4" ROUGH BRONZE CK STOPS	\$490.30	390 256	ADJUSTMENT KNOB RETAINER	\$24.20
230282G	BRT CHROME CHECK STOP	\$546.20	390 257	ADJUSTMENT KNOB RETAINER	\$40.30
230282M	1-1/4" POLYCHROME CHECK STOPS	\$616.40	390 258	ADJ KNOB RETAINER	NLA
230293BP	POPPET ASSY, QTY= 15	\$407.70	390 259	ADJ KNOB RETAINER, CHROME PLATE	NLA
331 266	TUBE, PLASTIC	\$9.20	390 286	N45 HYDRO GASKET KIT	NLA
331 268	PLASTIC TUBE	\$9.70	390 287	N45 HYDRO CHECK VALVE	NLA
331077A	DIAPHRAGM	\$162.40	390 294	431 HYDRO GASKET REP	\$62.20
390 001	MOTOR HOUSING	\$21.40	390 298	432 HYDRO GASKET REP	\$62.20
390 006	431 FUNNEL	\$19.90	390 302	433 HYDRO GASKET REP	\$93.60
390 010	ADAPTER, MOTOR	\$22.70	390 305	433 POPPET KIT, PRIOR KIT '91	\$543.90
390 012	KNOB	NLA	390 306	434 HYDRO GASKET REP	\$99.60
390 016	431 MOTOR REPLACEMENT KIT	\$362.40	390 311	CROSS HANDLE AND ADJ KNOB KIT	NLA
390 017	432 MOTOR REPLACEMENT KIT	\$362.40	390 313	HANDLE, CROSS FOR SERIES 431	NLA
390 018	431 CROSS HANDLE KIT	NLA	390 334	BODY CAP	NLA
390 024	ADAPTER, MOTOR	NLA	390 335	BODY CAP CHROME PLATED	NLA
390 026	ADJUSTMENT LOCKING SCREW	\$5.00	390 336	BODY CAP	NLA
390 036	432 ACTUATOR REPLACEMENT KIT	\$316.60	390 337	BODY CAP, CHROME PLATED	NLA
390 037	431 ACTUATOR REPLACEMENT KIT	\$316.60	390 340	ADJUSTMENT KNOB ASSEMBLY	NLA
390 039	434 ACTUATOR REPLACEMENT	\$475.80	390 342	ADJUSTMENT KNOB, ROUGH BEZ	\$56.00
390 048	COMPRESSION SPRING, HELICAL	\$5.60	390 466	432 POPPET KIT, PRIOR FEB '91	NLA
390 051	GASKET, MOTOR HOUSING	\$5.30	390 468	434 POPPET KIT, PRIOR FEB '91	\$496.50
390 056	BUSHING 1" X 1/2" HEX	\$14.00	390 491	POPPET	\$80.00
390 065	433 ACTUATOR REPLACEMENT KIT	\$395.10	390491JP	POPPET, QTY= 10	\$643.40
390 066	434 ACTUATOR REPLACEMENT KIT	\$467.80	390 500	432 HI/LO MOTOR REPL. KIT	\$291.80
390 067	431 POPPET REPLACEMENT KIT	\$265.00	390 504	MOTOR ADAPTER	\$42.70
390 068	432 POPPET REPLACEMENT KIT	\$295.40	390 505	MOTOR ADAPTER	\$21.40
390 069	433 POPPET REPLACEMENT KIT	\$496.50	390 507	WAX MOTOR	\$60.30
390 070	434 POPPET REPLACEMENT KIT	\$520.40	390 511	433 VALVE UPGRADE KIT	\$543.90
390 072	434 MOTOR HOUSING	NLA	390 512	434 VALVE UPGRADE KIT	\$589.70
390 095	GASKET	\$7.80	390 543	1434 MOTOR REPLACEMENT KIT	\$445.10
390 144	MOTOR HOUSING CAP	\$104.60	390 546	ADJUSTMENT SCREW	\$6.90
390 145	MOTOR HOUSING CAP	\$108.00	390 571	WRENCH	\$21.70
390 151	432 OVERLOAD ASSEM BY	NLA	390 579	ACTUATOR REPLACEMENT KIT	\$66.60
390 155	RETURN SPRING	\$5.30	390 580	CARTRIDGE REPLACEMENT KIT	\$153.30
390 156	CAP, MOTOR HOUSING/PLAIN	NLA	390 581	GASKET'S O-RING KIT	\$14.30
390 157	MOTOR HOUSING CAP	\$358.50	390 582	CARTRIDGE ES150	\$156.40
390 162	RETURN SPRING	\$6.70	390 619	ACTUATOR	\$71.20
390 169	KNOB, ADJUSTMENT, CHROME PLATE	NLA	390 620	SPRING	\$5.10
390 175	MOTOR HOUSING	\$268.80	390 671	ACTUATOR	\$138.50
390 178	MOTOR HOUSING CAP	NLA	390 777	TEMPERATURE ADJUSTMENT SCREW	\$5.30
390 179	MOTOR HOUSING CAP	\$256.50	390 795	ADJUSTMENT LOCKING SCREW	\$5.30
390 198	GASKET, MOTOR HOUSING	\$5.30	390 800	CHECKSTOP REBUILD KIT	\$69.50
390 201	MOTOR FAILURE SPRING	\$5.30	390 801	CHECKSTOP REBUILD KIT	\$80.60
390 225	MOTOR HOUSING CAP	NLA	390 802	PLUNGER KIT	\$19.50
390 226	MOTOR HOUSING CAP	NLA	390 803	PLUNGER KIT	\$21.70
390 239	OVERLOAD SPRING ASSEMBLY	NLA	390 804	SET SCREW	\$9.70
390 243	GASKET, MOTOR HOUSING	\$5.30	390 805	O-RING	\$5.40
390 248	SPRING, MOTOR FAILURE N 125	\$5.30	390 806	O-RING	\$5.40
390 254	ADJUSTMENT KNOB RETAINER	\$17.50	390 807	ACTUATOR	\$84.80

A WATTS Brand

Part No.	Description	List Price
390 808	ACTUATOR	\$84.80
390 809	ACTUATOR	\$148.40
390 810	ACTUATOR	\$135.80
390 811	CHECKSTOP REBUILD KIT	\$69.50
390 812	PLUNGER KIT	\$53.20
390 813	O-RING	\$5.40
390 814	ACTUATOR	\$395.50
390 815	ACTUATOR	\$395.50
390 816	PLUNGER KIT	NLA
390 826	FUNNEL KIT	\$138.40
390 827	FUNNEL KIT	\$155.60
390 828	FUNNEL KIT	\$179.60
390 829	FUNNEL KIT	NLA
390 830	FUNNEL KIT	\$203.40
390 831	FUNNEL KIT	NLA
390035BP	POPPET KIT (10)	\$574.80
390035JP	POPPET, QTY= 15	\$731.20
390046BP	POPPET, QTY= 25	\$134.80
390047JP	COPPER GASKET, QTY= 100	\$525.60
390051BP	GASKET MOTOR HOUSING, QTY= 25	\$76.00
390146JP	POPPET, QTY= 15	\$792.20
390155BP	SPRING, QTY= 25	\$89.30
390166A	SCREW, ADJ	\$9.80
390169G	KNOB, ADJUSTMENT BRIGHT CHROME	\$68.60
390228BP	POPPET, QTY= 10	\$482.60
390228JP	POPPET, QTY= 15	\$643.50
390230JP	POPPET, QTY= 25	\$858.40
390247BP	POPPET STEM. QTY= 25	\$194.60
390248BP	SPRING, QTY= 25	\$45.70
390257G	ADJ. KNOB RETAINER BRIGHT CHROME	\$28.00
390259G	ADJ. KNOB RETAINER BRIGHT CHROME	NLA
390343A	ADJUSTMENT SCREW	\$5.30
390485BP	POPPET	\$186.50
390485JP	POPPET, QTY= 5	\$643.40
390493BP	POPPET, QTY= 5	\$453.40
390493JP	POPPET, QTY= 10	\$770.30
400 023	SHUT OFF DISC	\$5.30
400 062	DIAL ASSEM REPL KIT SERIES 400	NLA
400 065	HARDWARE PACKAGE	\$4.70
400 066	HARDWARE PACKAGE	\$16.00
400 068	HARDWARE PACKAGE	\$11.80
400 070	HARDWARE PACKAGE	NLA
400 078	HARDWARE PKG KIT	\$49.80
400 085	CONVERSION KIT FOR 406 DIVERTER	\$58.00
400023BP	SHUTOFF DISC BULK, QTY= 25	\$41.90
400023JP	SHUTOFF DISC, QTY= 500	\$525.60
400062BP	DIAL ASSEMBLY REPLACEMENT	NLA
401 086	PLASTIC HANDLE	\$38.50

Part No.	Description	List Price
401 087	ESCUTCHEON, PLASTIC	\$35.90
401 088	STEM GUIDE	NLA
401 090	PLUG BUTTON	\$8.70
401 091	COLOR INDICATOR RING	\$16.80
401 093	INDICATOR LABEL	\$5.30
401 100	DIAL ASSEM W/O DIVERTER	NLA
401 146	THROTTLING STEM MOLDED	\$5.30
401 161	RUBBER GASKET	\$5.30
401 162	BONNET MOLDED R/B 401162BP	NLA
401 165	MAX. TEMPERATURE STOP	\$5.30
401 175	BAL CHAMBER REPL KIT 400 & 410	\$109.70
401 176	STEM REPL KIT 400 HYDROGUARD MD4	\$31.50
401 177	SELECTOR DIAL	\$43.80
401 178	ROUGHING IN GUIDE FOR MD4	\$5.50
401 202	BAL. CHAMBER EXTRACTOR KIT	\$28.70
401 210	STRAINER CAP	\$5.30
401 218	MAX. TEMPERATURE STOP	\$5.30
401 229	ADHESIVE GASKET	\$5.30
401 230	DIAL ASSEMBLY	\$80.50
401 231	SELECTOR DIAL	\$32.60
401 253	SLEEVE	\$17.50
401 256	RUBBER GROMMET	NLA
401 267	SLEEVE	\$8.90
401 278	STOP, ADJUSTABLE	\$5.30
401090A	PLUG BUTTON	\$5.30
401090K	PLUG BUTTON KIT	\$34.70
401092BP	NAME PLATE, QTY= 25	\$155.30
401092JP	NAME PLATE, QTY= 100	\$401.80
401100BP	DIAL ASSEMBLY, QTY= 5	NLA
401161BP	RUBBER GASKET BULK 25/KIT	\$42.90
401162BP	BONNET, QTY= 15	\$325.90
401218BP	MAX TEMP STOP BULK 25/KIT	\$91.60
401225BP	RETAINER, QTY= 25	\$114.20
401230A	DIAL ASSEM KIT 400 HYD MD4	\$167.40
401230B	401 COMPLETE DIAL ASSEMBLY	\$201.20
401230JP	DIAL ASSEMBLY, QTY= 10	\$682.50
401267JP	SLEEVE QTY=100	\$585.00
401278BP	STOP KIT, ADJUSTING (QTY= . 25)	\$95.50
403 005	NUT ADJUSTMENT SCREW	\$5.30
403 007	PIPE PLUG BRASS	\$5.30
403005G	ADJUSTING SCREW NUT	\$4.70
410 111	VALVE BODY ASSEMBLY, PE	NLA
410 138	SHUT OFF DISC SPG	\$5.30
410 145	WASHER, WAVY	\$5.30
410 146	GASKET	\$9.50
410 147	LIMIT STOP	\$5.30
410 157	VOLUME VALVE	\$5.30
410 166	SPEED NUT	NLA

A WATTS Brand

Part No.	Description	List Price	Part No.	Description	List Price
410 167	SLEEVE, LEVER SCREW	NLA	410 452	VALVE BODY ASSEM HYDROPANEL	NLA
410 182	SER 410 HYDRO GASKET REPL KIT	\$25.90	410 460	PLUG DIVERTER	\$41.70
410 183	410 BAL CHAMBER REPL	\$105.70	410 473	410 TRIM UPGRADE W/473	NLA
410 191	HANDLE	\$95.25	410 520	410 BODY ASSEMBLY	NLA
410 195	PLUG BUTTON	\$6.70	410 522	3 PORT BODY ASSEMBLY	NLA
410 203	COUPLING	\$6.90	410 565	TRI HANDLE KIT	\$85.10
410 233	STEM EXTENSION KIT	\$28.10	410 570	SEAL KIT, OVER SIZE 410 INLET	\$21.40
410 243	VALVE BODY MACHINED	\$130.60	410138BP	SHUTOFF DISC SPRING BULK, QTY=25	\$69.30
410 248	BAL CHAMBR KIT 440 FOTOPL	\$118.20	410144JP	WASHER, QTY= 500	\$74.40
410 284	GASKET	\$5.30	410145JP	WASHER, QTY= 500	\$331.60
410 330	CHAMBER ASSEMBLY	\$34.50	410146BP	GASKET, QTY= 10	\$81.80
410 339	RETAINER (FOR DIE, CAST DIAL)	\$11.80	410146JP	GASKET, QTY= 500	\$3,869.50
410 346	BONNET	\$34.10	410284BP	GASKETS 410 BULK PK, QTY= 25	\$38.10
410 351	ROUGH IN GUIDE	\$44.50	410374BP	DIAL INSERT, QTY= 15	\$253.60
410 352	BONNET	\$108.00	410374JP	DIAL INSERT, QTY=50	NLA
410 359	HANDLE	NLA	410375BP	STEM ASSY, QTY=15	\$395.80
410 365	LEVER HANDLE SCREW KIT (10)	\$17.10	410375JP	STEM ASSEMBLY, QTY= 25	\$627.70
410 366	O RING KIT, 047 020 QTY=.25	\$13.20	410378A	STEM REPLACEMENT KIT	\$76.50
410 367	RETAINER KIT (10)	\$47.80	410393JP	BONNET, QTY= 50	\$969.10
410 368	WASHER KIT (15 PER KIT)	\$22.70	410413JP	DIAL PLATE, QTY= 25	\$873.60
410 369	WAVY WASHER KIT (10 PER KIT)	\$17.10	410427BP	FLOW RESTRICTOR 410, QTY= 25	\$68.60
410 370	GASKET KIT (10)	\$21.90	410442BP	GRAPHIC INSERT QTY= 15	\$265.90
410 371	SPLINED STOP 400 KIT (6)	\$25.90	410448BP	410 LEVER HANDLE KIT, QTY= 10	\$430.00
410 372	VOLUME VLV KIT 410 (2)	\$21.40	410448JP	LEVER HANDLE KIT, QTY= 15	NLA
410 374	DIAL INSERT STD	\$21.80	420 034	VALVE ASSEMBLY	\$317.50
410 375	THROTTLING STEM ASSEMBLY	\$29.90	420 102	WASHER KIT	\$26.90
410 377	SUPPORT RING	\$15.20	420 104	EYE BOLT	\$14.20
410 378	STEM REPLACEMENT KIT	\$43.80	420 105	MOUNTING BODY, 420 KNEE OPERA	\$203.30
410 383	LUCITE HANDLE KIT	NLA	420 114	VALVE	\$154.10
410 384	LEVER HANDLE KIT	\$62.20	420 115	PUSH ROD	NLA
410 389	DIAL ASSEMBLY KIT	\$141.00	420 122	ADJUSTMENT STEM	NLA
410 393	PLASTIC BONNET (410 111)	\$24.60	420 124	TEMP STOP	\$5.00
410 396	BONNET KIT	\$68.60	420 128	VALVE ASSEMBLY	\$465.60
410 398	LIMIT STOP	NLA	420 130	GASKET	\$5.30
410 404	DIAL ASSEMBLY, DELUXE	NLA	420 139	STEM ASSEMBLY	NLA
410 413	DIAL 410	\$44.40	420 143	VALVE ASSEMBLY	\$338.00
410 414	DIAL	NLA	420 145	INSTALLATION TOOL	NLA
410 415	LEVER ASSEMBLY, PLATED	NLA	420 157	ADJUSTMENT STEM ASSEMBLY	NLA
410 417	RETAINER	\$9.30	420 159	FULL UPGRADE KIT	NLA
410 427	SPRING GUIDE FLOW RESTRICTOR	\$5.30	420 166	DIAL POLISHED FINISH	\$43.60
410 430	DIAL INSERT	\$13.10	420 182	DIAL ASSEMBLY KIT	\$141.00
410 437	REDUCER 1/2" X 3/8" WPT BRASS	\$10.90	420 202	ROUGHING IN GUIDE	\$5.30
410 440	BALANCE CHAMBER ASSEMBLY	\$75.90	420 208	BONNET ASSEMBLY	NLA
410 442	410 GRAPHIC INSERT ASSEMBLY	\$21.30	420 212	MAX. TEMP. STOP KIT (5)	\$28.70
410 445	STANDARD 410 DIAL ASSEMBLY GRAY	\$89.30	420 213	LUCITE HANDLE INSERT KIT (2)	\$28.70
410 446	DELUXE 410 DIAL SSS, GREY	NLA	420 214	BONNET SCREW KIT (12)	\$24.70
410 447	410 KNOB ASSEMBLY, ACRYLIC	\$44.00	420 215	HANDLE SCREW (4)	\$14.60
410 448	410 LEVER ASSEMBLY	\$44.00	420 216	DIAL RETAINING SCREW KIT (20)	\$29.80

A WATTS Brand

Part No.	Description	List Price
420 217	MTG SCREW KIT 20 PCS 080 013	\$63.20
420 218	LEVER HANDLE SCREW KIT (10)	\$20.30
420 222	MAX. TEMP. KIT (420) 4 PER KIT	NLA
420 225	PLUG BUTTON KIT (4 PIECES)	\$34.40
420 230	HANDLE ASSEMBLY R/B 420 243	\$68.60
420 232	SLEEVE KIT	\$17.20
420 237	RAINBOW INSERT FOR 420	\$21.70
420 238	DIAL INSERT/CELSIUS, SERIES 420	\$24.50
420 239	MOUNTING KIT	\$91.00
420 242	427 TRI HANDLE KIT	\$87.20
420 243	420 LEVER HANDLE KIT	\$70.50
420 267	VANDAL PROOF HARDWARE 420 410	\$9.70
420 272	TRIM PACKAGE W/STL DIAL	\$76.50
420 300	KNOB ACRYLIC	\$21.70
420 308	GRAPHIC INSERT ASSEM, 420	\$22.00
420 314	PLUG BUTTON W/INSERTS	\$11.30
420 328	NAME PLATE TRIM	\$22.00
420 330	NAME PLATE & BASE PLATE ASSEMBLY	\$45.70
420 335	420 DIAL ASSEMBLY, GREY INSERT	\$89.30
420 336	420 LEVER ASSEMBLY	\$89.30
420 337	KNOB KIT 420, MODEL 8	\$85.30
420 356	420 LEVER ASSEMBLY	\$103.70
420 357	KIT, FULL UPGRADE MODELS 1-10 LCM	\$429.90
420 442	UPGRADE KIT W/BONNET & RUBBER SEAT	NLA
420 443	UPGRADE KIT W/BONNET, RUBBER SEAT, SCREEN	\$333.40
420 445	KIT, CARTRIDGE, W/RUBBER SEAT & SCREEN	\$87.60
e420449	440 FOTOGUARD BODY ASSY	\$434.40
e420450	440 BODY ASY BR CHR MD7	\$641.20
420 451	KIT, FULL UPGRADE STD. MODELS 1-10	\$296.00
420 452	CARTRIDGE MODEL 1-10	\$50.70
420 453	WAX MOTOR KIT,STD. MODELS 1 10	\$66.20
420 454	BONNET KIT, MODELS 1 10	\$211.30
420 456	SEAL KIT, MODELS 1 10	\$12.10
420 481	PLASTIC KNOB KIT	\$62.20
420 485	420 DIAL KIT POLISHED BRASS	\$285.80
420 495	410 LEVER HANDLE KIT	\$49.80
420 508	RING, PACK STOP BRASS MODEL 8	\$5.30
420 517	SEAT HW STD/HI CAP & L HWT	NLA
420 521	COMBINATION SEAT KIT 7 GALLON	NLA
420 524	O-RING KIT UNDER COUNTER MIXER	\$9.70
420 534	VALVE ASSEMBLY	\$265.90
420 552	VALVE ASSEMBLY STD LO CAP	NLA
420 553	VLV ASSEMBLY LOW HW TEMP HI CAP	NLA
420 578	PACKING GLAND	\$10.70
420 610	420 UTC BONNET REPLACEMENT KIT	NLA
420 611	420 UTC UPGRADE KIT, STD. TEMP.	NLA
420 616	UPGRADE KIT, STD. TEMP.	\$191.70
420124JP	TEMPERATURE STOP QTY=100	\$483.50

Part No.	Description	List Price
420125BP	KNOB INSERT, QTY= 25	\$224.20
420125JP	KNOB INSERT QTY= 100	\$585.00
420166BP	DIAL PLATE, QTY= 15	\$545.90
420166JP	DIAL PLATE QTY= 25	\$627.70
420190JP	KNOB & SLEEVE QTY= 25	\$504.50
420230A	419 LEVER HANDLE	\$58.00
420231BP	LEVER HANDLE QTY= 15	\$351.10
420231JP	LEVER HANDLE, QTY= 50	\$861.80
420232JP	SLEEVE, QTY= 50	\$624.00
420237BP	DIAL INSERT, QTY= 15	\$257.50
420237JP	DIAL INSERT QTY= 50	\$731.20
420265BP	STOP RING QTY= 25	\$72.70
420301E	HANDLE, LEVER CHROME PLATED	\$44.50
420308BP	GRAPHIC INSERT QTY= 15	\$269.10
420451C	KIT, HIGH CAPACITY CONVERSION, MOD. 1-10	\$296.00
420451H	KIT, FULL UPGRADE, HIGH TEMP. MOD. 1-10	\$296.00
420451L	KIT, FULL UPGRADE, LOW TEMP. MOD. 1-10	\$296.00
420452C	CARTRIDGE ASSEMBLY TYPE "H" CAP	\$50.70
420453H	WAX MOTOR HIGH TEMP. MOD. 1-10	\$66.20
420453L	WAX MOTOR LOW TEMP. MOD. 1-10	\$66.20
420508BP	PACKING RING, QTY= 25	\$99.60
420508JP	PACKING RING QTY= 250	\$779.80
420518A	SEAT, COMB STD/HI CAP	\$11.80
420615C	UPGRADE KIT, UTC, HIGH CAP.	NLA
420615L	UPGRADE KIT, UTC, LOW TEMP.	\$191.70
420616H	UPGRADE KIT, HIGH TEMP.	\$191.70
420616L	UPGRADE KIT, LOW TEMP.	NLA
427 017	CARTRIDGE ASSY.	\$76.40
H427017	CARTRIDGE ASSY.	\$101.00
427 019	BONNET ASSY.	\$110.80
427 200	UPGRADE KIT 427	\$310.00
427 201	UPGRADE KIT - LOW TEMP, 427	\$373.10
427 202	UPGRADE KIT - HIGH TEMP, 427	\$373.10
427 250	MOTOR KIT - STANDARD TEMP	\$131.60
427 251	MOTOR KIT - LOW TEMP	\$131.60
427 252	MOTOR KIT - HI TEMP	\$131.60
H427200	e427 UPGRADE KIT MODEL 1-3	\$310.00
H427201	e427 UPGRADE KIT LOW TEMP.	\$347.30
H427202	e427 UPGRADE KIT HI TEMP.	\$347.30
430 016	TEMP ADJ LOCK SCREW KIT (10)	\$24.70
430 017	431 TEMP. ADJ. LOCKSCREW KIT	\$24.70
430 020	MAX. TEMP. ADJ. KIT	\$25.90
430 021	SPRING KIT	\$25.90
436 036	WASHER	\$5.30
436031G	RETAINING SCREW	NLA
440 017	ELBOW ASSEMBLY 1/2" X 1/2"	\$126.30
440 034	VOLUME KNOB	\$38.60
440 035	VOLUME KNOB	\$27.70

A WATTS Brand

Part No.	Description	List Price	Part No.	Description	List Price
440 041	DIAL	\$56.00	444 183	SOLENOID REPAIR KIT	\$207.80
440 059	DIAL INSERT FOR FOTOGUARD	\$78.20	444 199	CABLE EXTENSION MODIFIED	\$72.70
440 103	CONNECTOR	\$65.00	444 254	SOLENOID ADAPTER	\$35.00
440 121	VOLUME STEM EXTENSION	\$93.60	444 260	SWITCH PIEZO	\$184.40
440 125	SHUT OFF VALVE STEM EXT	\$22.60	444 308	LOCK NUT, 1-3/8" 18	\$16.20
440 145	ON OFF VALVE REPAIR KIT MDL5	\$41.20	444 416	SWITCH PIEZO	\$188.90
440 151	SHUT OFF DISC	\$8.60	444 424	ANCHOR PLATE	\$66.80
440 152	SHUT OFF DISC SPRING	\$5.30	445 102	BODY, STEAM & WATER MIXER	\$559.80
440 154	SHUT OFF MANIFOLD	\$45.70	445 105	BONNET PLAIN	\$211.30
440 157	ADAPTOR	\$11.60	445 125	CHECK STOP	NLA
440 158	SPRING GUIDE	\$5.40	445 126	CHECK STOP ASSY, 1/2" BRT CHR.M.	NLA
440 159	SHUT OFF STEM ASSEMBLY	\$72.70	445 130	DISC HOLDER	\$9.50
440 160	SHUT OFF STEM ASSEMBLY	\$172.60	445 131	CARTRIDGE ASSEMBLY	\$730.30
440 167	HANDLE SCREW	\$9.70	445 134	STEM	NLA
440 168	HANDLE SCREW	\$11.90	445 135	STEM	NLA
440 169	SHUT OFF HANDLE	\$22.60	445 136	BONNET	NLA
440 170	VOLUME STEM EXTENSION	\$36.40	445 137	BONNET, STEAM WATER MIXER BR.	NLA
440 171	VOLUME STEM EXTENSION	\$86.90	445 138	POPPET SPRING	NLA
440 172	VOLUME HANDLE	\$34.50	445 141	REPAIR KIT STEAM WATER MIXER	NLA
440 173	KNOB INSERT	\$75.90	450 135	MOUNTING BRACKET	\$53.60
440 175	440 CABINET	\$708.00	450 136	PIPE STRAPS	\$5.90
440 176	CABINET FOR FOTOPANEL	\$634.00	450 149	MOUNTING NUT	NLA
440 177	CONNECTOR	\$140.20	450 268	SOAP DISH HYDRO II	\$91.40
440 178	THERMOMETER MANIFOLD MOLD	\$69.30	450 270	DIAL INSERT	\$27.70
440 205	ON OFF VALVE REPLACEMENT UNIT	\$229.60	450 271	SCREW. 8-32 X 1/2" POLISHED	\$5.30
440 207	DIAL POL FOR 440 208	\$87.20	450 272	SCREW DIAL INSERT V/P	\$14.20
440 212	NAME PLATE	\$10.90	450 273	SCREW, ST STL 10-32 X 3/8"	NLA
440 223	QUAD RING KIT 440 FOTO (7)	\$25.90	450 274	SCREW	\$5.30
440 224	WASHER KIT (8 PC)	\$27.70	450 276	SCREW	\$6.70
440 231	BRACKET MOUNTING	\$86.90	450 277	GASKET, SHOWER HEAD BASE	\$5.30
440 234	BRACKET ASSEMBLY	\$109.00	450 295	BRACKET, MOUNTING	\$34.50
440 235	VALVE REPLCMT UNIT FOR 440 3000	\$321.30	450 327	SHROUD EXTENSION 24" BRACKET	\$160.20
440041A	DIAL WITHOUT LOGO	\$56.00	450 334	BRACKETS, MTG	\$51.90
440174A	FRONT PANEL	\$171.20	450 352	HYDROGUARD ASSEMBLY,EXTENDED	NLA
440181A	PANEL, FRONT	\$204.30	450 353	COVER PLATE	NLA
444 104	AERATOR KIT	\$16.70	450 356	COVER PLATE	\$146.90
444 107	SPOUT HARDWARE KIT	\$58.50	450 447	MOUNTING BRACKET	NLA
444 109	GN SPOUT	\$95.70	450183B	BACK PLATE ASSEMBLY	\$174.10
444 110	GN BASE	NLA	450192RK	SLEEVE KIT	\$38.40
444 118	PLUG-IN TRANSFORMER	NLA	450267G	SHOWER HEAD BASE	\$166.20
444 122	FAUCET SENSOR	\$29.60	450269G	CAP. END CHROME PLATE	\$47.80
444 126	SCREWDRIVER ESP SHOWER	\$9.70	450273A	SCREW	\$5.30
444128A	GN SPOUT INSTALLATION KIT	NLA	450273BP	SCREW BULK PACK KIT (QTY= 25)	\$37.20
444 135	COVER KIT	\$10.90	460 040	KNOB ASSEMBLY, ADJUSTMENT	\$66.60
444 137	HARDWARE	\$13.70	460 041	ADJ KNOB ASSEMBLY	\$261.20
444 142	JUNCTION BOX ASSEM	\$39.50	460 172	RED INDICATOR LIGHT	\$64.20
444 161	CONTROL BOX	NLA	460 173	MINIATURE LAMP	\$13.20
444 174	SOLENOID VALVE	\$345.20	460 231	CABINET DOOR ASSY	\$506.00
444 182	SOLENOID REPAIR KIT	NLA	460 248	SWITCH, SELECTOR	\$213.80

A WATTS Brand

Part No.	Description	List Price
460 323	TIMER W/KNOB & POTENTIOMETER	\$617.10
460 378	REPAIR KIT 1-1/2" SOLENOID	\$285.80
460 454	FITTING 1/2" NPT X 1/4" TUBE	\$25.60
460051R	REPAIR KIT FOR 1" SOLENOID	\$222.40
460053R	REBUILD KIT 1-1/2"	\$437.80
460172A	GREEN INDICATOR LIGHT	\$70.50
460292R	SOLENOID REPAIR KIT	\$969.80
473 015	GROMMET RUBBER	\$5.30
473 010	LEVER HANDLE	\$83.00
473 016	GASKET	\$6.60
473 017	ROUGH IN GUIDE	NLA
473 021	CROSS	\$58.50
473 022	NUT COMP.	\$10.00
473 033	410 3 PORT, BOTTOM OUT W/CROSS	NLA
473 035	HANDLE KIT	\$95.50
473 037	KIT, STEM EXTENSION	\$72.70
473 038	KIT, FACE PLATE	NLA
473 039	KIT, TEMPERATURE DISPLAY	\$240.30
473 042	KIT, POWDER COATED SCREW	\$12.30
473 044	KIT, INSTALLATION	NLA
473 045	INSTALLATION KIT	\$16.20
480 270	MOTOR REPLACEMENT KIT	\$30.40
480016M	480 MOTOR ASSEMBLY	NLA
483 026	LCD TRIM KIT (DEGREE F)	NLA
483 035	HANDLE KIT	\$141.00
490 050	HANDLE KIT LM 490 SERIES	NLA
590 088	VLV PKG KIT 200 PCS 591 490	\$981.70
590 089	3/4" VALVE PKG RING KIT	\$974.20
590 131	BONNET	\$134.60
590 134	BONNET	\$132.70
590 140	BONNET	\$165.10
590 164	MOLYKOTE LUBRICANT	\$100.40
590 203	STEM EXTENSION	\$49.20
590 204	STEM EXT.	\$28.60
590 233	UNION TAIL PIECE	\$113.40
590 234	UNION NUT	\$51.90
590 328	STOP SLEEVE	\$32.70
590 329	STOP SLEEVE	\$153.50
590 402	BONNET	NLA
590 432	THROTTLING DISC	\$550.90
590 434	VLV FLANGE & SEAT ASSEMBLY	\$586.40
590 435	VLV FLANGE & SEAT ASSEMBLY	\$335.70
590 462	STEM EXT SPACER	\$5.80
590 464	STEM EXT SPACER	\$13.20
590 487	1/2" VALVE BODY	\$113.40
590 488	VALVE BODY	\$171.20
590 567	1/2" POPPET	\$215.90
590 568	POPPET	\$242.00
590 569	POPPET	\$295.10

Part No.	Description	List Price
590 575	POPPET	\$171.20
590 584	VALVE BODY	\$171.20
590 585	VALVE BODY	\$171.20
590 604	STEM RETAINER	\$16.70
590 605	STEM RETAINER	\$53.60
590 606	STEM RETAINER	\$36.10
590 607	RETAINING STOP NUT	\$166.00
590 608	VALVE SEAT	\$39.60
590 610	VALVE SEAT	\$49.20
590 612	VALVE SEAT	\$62.40
590 623	DISC GUIDE	\$34.30
590 624	DISC GUIDE	\$13.20
590 650	POPPET	\$65.00
590 651	POPPET	\$53.60
590 664	POPPET	\$47.10
590 665	POPPET	\$69.30
590 666	R.A.POPPET	\$69.30
590 667	R.A.POPPET	\$69.30
590 668	VALVE BODY	\$160.60
590 684	VALVE SEAT	\$111.20
590 690	HLDR & STEM EXT ASY	\$220.40
590 691	HOLDR & STEM EXT ASY	\$220.40
590 692	COMP DISC/HOLDER/STEM EXT ASSY	\$253.20
590 693	STEM EXTENSION	\$42.60
590 743	STEM EXT & HLDR ASY	\$169.60
590 746	VALVE SEAT	\$50.40
590 748	VALVE SEAT	\$98.00
590 749	DISC HOLDER	\$53.60
590 756	DISC HOLDER	\$42.60
590 757	THRUST COLLAR	\$32.70
590 758	DISC GUIDE	\$26.40
590 759	DISC GUIDE	\$23.10
590 760	DISC GUIDE	\$19.50
590 762	SPACER	\$23.10
590 763	PACKING GLAND ASSY	\$24.90
590 775	DISC SLEEVE	\$32.70
590 779	STEM EXT & HLDR ASY	\$233.70
590 807	SPRING ADJM SCREW	\$32.70
590 813	SPG POSITION INDTR	\$5.30
590 814	SPRING GUIDE WASHER	\$13.20
590 815	PISTON PLATE WASHER	\$5.30
590 816	PISTON PL RTNING SCR	\$5.30
590 820	ADJUSTING ROD	\$5.00
590 821	SPRING	\$32.70
590 829	SPRING ADJM NUT ASY	\$39.50
590 859	LOWER HOUSING ASSY	\$159.40
590165A	SEAL	NLA
590404E	STOP SLEEVE 1-7/8" X 1-15/16"	\$29.10
590418A	GUIDE ROD & CAP ASSEMBLY	\$69.30

A WATTS Brand

Part No.	Description	List Price	Part No.	Description	List Price
590418D	GUIDE ROD ASSY	NLA	591 912	DA NUT	\$16.70
590421A	STOP SPACER	\$10.00	591 916	1-1/2" RA NUT	\$82.30
590607A	RETAINING NUT STOP	\$29.60	591 919	WASHER (1/2" TO 1")	\$5.30
590607B	RETAINING STOP NUT	\$29.60	591 920	PACKING SPRING (1/2" TO 1")	\$5.30
590808B	STEM EXTENSION	\$9.80	591 921	PACKING ASSEMBLY (1/2" TO 1")	\$39.60
591 692	3" DISC HOLDER ASSY	\$739.50	591 922	SPACER (1/2" TO 1")	\$8.60
591 732	VALVE ASSEMBLY	\$976.00	591 923	WASHER (1-1/4" TO 2")	\$5.30
591 733	VALVE ASSEMBLY	\$1,010.00	591 924	PACKING SPRING (1-1/4" TO 2")	\$5.30
591 750	BODY, 3/4" VALVE, DIRECT ACTING	\$242.00	591 925	PACKING ASSEMBLY (1-1/4")	\$96.20
591 760	3/4" BONNET	\$148.20	591 926	SPACER (1-1/4" TO 2")	\$5.30
591 762	1-1/4" BONNET	\$165.10	591 927	STEAM SERVICE PKG KIT	\$85.90
591 765	3/4" THROTTLING PLUG	\$49.20	591 928	STEAM SERVICE PACKING KIT	\$96.20
591 766	1" THROTTLING PLUG	\$88.80	591 949	POPPET 1-1/4" S.S.	\$208.10
591 767	1-1/4" THROTTLING PLUG	\$88.80	591 950	1-1/2" S S POPPET DIRECT & REV	\$265.70
591 768	1-1/2" THROTTLING PLUG	\$49.20	591 951	2" S S POPPET DIRECT & REV	\$357.90
591 769	2" THROTTLING PLUG	\$100.40	591 957	PACKING SET FOR FLOWWRITES	\$22.30
591 770	3/4" VALVE DISC HOLDER	\$26.80	591 958	CHEVRON PKG	\$32.70
591 771	1" VALVE DISC HOLDER	\$71.40	591 964	REBUILDING KIT	\$422.30
591 772	1-1/4" VALVE DISC HOLDER	\$16.70	591 974	VALVE REPAIR/REBUILD KIT	\$410.10
591 773	1-1/2" VALVE DISC HOLDER	\$53.60	591 975	REBUILDING KIT	\$723.90
591 774	2" VALVE DISC HOLDER	\$113.40	591 980	VLV REBUILD/REPAIR KIT WM	\$742.00
591 775	3/4" VALVE DISC	\$13.20	591 989	REBUILD KIT 4" FL II	\$3,913.00
591 776	1" VALVE DISC	\$10.40	591 998	REBUILDING KIT 4"	\$1,991.30
591 777	VALVE DISC	\$9.80	591768A	1-1/2" THROTTLING PLUG	\$171.20
591 778	1-1/2" VALVE DISC	\$9.80	591771A	1" VALVE DISC HOLDER	\$128.10
591 779	2" VALVE DISC	\$68.30	591772A	1-1/4" VALVE DISC HOLDER	\$220.20
591 781	1" VALVE CAP	\$111.20	591773A	1-1/2" VALVE DISC HOLDER	\$251.20
591 783	PACKING GLAND ASSEMBLY	\$38.60	591774A	2" VALVE DISC HOLDER	\$291.10
591 786	STEM ASSEM 3/4" & 1" VALVES	\$141.50	591817E	STEM ASSEMBLY	\$215.40
591 789	1-1/4" VALVE STEM ASSEMBLY	\$141.50	591843C	STEM FOR FLOWWRITE 9-1/4" LONG	NLA
591 790	1- 1/2" VALVE STEM	\$141.50	591843D	STEM	\$171.20
591 791	VALVE STEM ASSEMBLY	\$141.50	591922A	SPACER	\$8.25
591 792	1-1/4" VALVE STEM	\$100.40	593002E	MTG.KIT I/P & POS., 46" ACT.	\$391.00
591 793	1-1/2" VALVE STEM	\$71.40	593003F	MTG.KIT I/P & POS., 46" ACT.	NLA
591 795	COLLAR	\$39.60	594 080	PACKING SET TFE 1/4" DIA. STEM	\$49.20
591 796	BEARING	\$9.80	594 081	PACKING SET TFE 3/8" DIA. STEM	\$49.20
591 797	BEARING	\$5.30	594 090	PACKING SET EP 1/4" DIA. STEM	\$19.80
591 798	PACKING SPACER	\$28.30	594 091	PACKING SET EP 3/8" DIA. STEM	\$19.80
591 802	STOP SLEEVE	\$82.30	594 099	BRAIDED GRAPHITE/ZINC PACKING	\$120.30
591 803	STOP SLEEVE	\$42.60	594 104	BONNET 1/2"	\$135.70
591 843	STEM	\$306.50	594 106	CAP 1/2"	\$71.40
591 896	1/2" VALVE DISC HOLDER	NLA	594 107	VALVE SEAT 1/2"	\$100.40
591 898	VALVE DISC 1/2"	\$59.40	594 118	WASHER FOR 1/4" DIA. STEM	\$5.30
591 899	VALVE DISC 3/4"	NLA	594 119	WASHER FOR 3/8" DIA. STEM	\$5.30
591 900	VALVE DISC 1"	NLA	594 126	BONNET, MACHINED 3/4" & 1"	\$135.70
591 901	VALVE DISC	NLA	594 129	VALVE SEAT FOR REPAIR ONLY	\$106.40
591 902	VALVE DISC 1-1/2"	\$151.40	594 137	BONNET	\$162.40
591 903	VALVE DISC 2"	\$151.40	594 140	VALVE SEAT 1-1/4" N.C.	\$109.80
591 907	NUT DA	\$53.70	594 152	BONNET 2"	\$224.50

A WATTS Brand

Part No.	Description	List Price
594 155	VALVE SEAT	\$122.20
594 157	PACKING NUT ASSEM. 1/4" STEM	\$24.90
594 158	PACKING NUT ASSEM. 3/8" STEM	\$28.40
594 170	PACKING RING	\$5.00
594 171	PACKING RING	\$5.30
594 194	CAP 3/4" & 1"	\$75.90
594 195	CAP 1-1/4" & 1-1/2"	\$100.40
594 196	CAP 2"	\$113.40
594 220	WATER SERVICE PACKING KIT 1/4"	\$47.50
594 221	WATER SERVICE PKG KIT 3/8"	\$69.10
594 251	LOCK NUT	\$50.80
594 289	WATER PACKING KIT FOR 1" VALVE	\$39.60
594 290	WATER PACKING KIT 3/8" 4 SETS	\$39.60
594 354	2" BRONZE POPPET ASSEMBLY	\$285.50
594 370	GASKET 5" KECKLEY VALVE	\$162.40
594 451	2" VALVE BODY RA	\$533.00
594 456	2" BONNET	\$159.40
594 457	BONNET	\$212.60
594 466	VALVE CAP 2"	\$111.20
594 467	1" BONNET	\$96.20
594 468	BONNET	\$186.60
594 470	VALVE CAP 1-1/2"	\$88.80
594 472	CAP 1-1/2"	\$47.60
594 475	VALVE SEAT 1-1/2"	\$98.00
594 477	1-1/2" VALVE BODY	\$357.90
594 478	VALVE BODY	\$356.00
594 479	1-1/2" BONNET	\$212.60
594 481	1-1/2" BONNET	\$130.00
594 488	1-1/4" RA 3 WAY VALVE	\$220.20
594 489	VALVE BODY	\$225.30
594 490	1-1/4" D.A. VALVE BODY	\$162.80
594 499	BONNET	\$97.40
594 500	1" VALVE BODY, R.A. 3 WAY	\$160.20
594 501	1" VALVE BODY	\$251.20
594 504	1" CD VALVE BODY	\$224.50
594 505	BODY	\$134.20
594 506	BODY	\$182.00
594 513	VALVE SEAT 1"	\$100.40
594 515	YOKE & BRIDGE ASSEMBLY BLUE	\$49.20
594 542	BODY & SEAT ASSEMBLY	\$495.30
594 549	1-1/4" N.O. STEM ASSEMBLY	\$251.20
594 550	STEM ASSY 1-1/2"	\$268.80
594 551	2" N.O. STEM ASSY	\$271.10
594 558	STEM 1-1/4" NORMALLY CLOSED	NLA
594 559	1-1/2", NORMALLY CLOSED	NLA
594 566	STEM, 2" NORMALLY CLOSED	\$386.60
594 568	BODY & SEAT ASSEMBLY	\$351.10
594 570	1/2" N.O VALVE STEM ASSEMBLY	\$188.90
594 571	VALVE STEM ASSEMBLY N.O.	\$251.20
594 572	N.O. VALVE STEM ASSEMBLY (1")	\$224.50

Part No.	Description	List Price
594 574	VALVE STEM ASSEMBLY, 3/4" N.C	NLA
594 575	N.C. VALVE STEM ASSY 1"	NLA
594 819	STEM ASSEMBLY	\$49.20
594813A	STEM ASSEMBLY	\$71.40
594814D	STEM ASSEMBLY	\$73.50
594814H	STEM ASSEMBLY	\$73.50
594815A	STEM ASSEMBLY	\$71.40
594816E	STEM ASSEMBLY	\$71.40
594816F	STEM	\$71.40
594817A	STEM ASSEMBLY	\$71.40
594817D	STEM ASSEMBLY	\$71.40
594818A	STEM ASSEMBLY	\$71.40
595 496	PARTS KIT #11 REG	\$19.40
595 499	NAME PLATE	\$5.30
595 501	INNER SPRING #11 LOWER HOUSING	\$13.20
595 502	OUTER SPRING #11 LOWER HOUSING	\$19.80
595 503	SPRING GUIDE WASHER #11 REG.	\$5.30
596 150	DIAPHRAGM	\$160.60
596 151	ROLLING DIAPHRAGM	\$366.30
597 030	NUT, SQ. 5/16 18 X 17/64 X 9/16	\$9.80
597015A	STEM EXTENSION FOR 597 REG.	\$88.80
601 004	UNION NUT 1/2"	\$29.80
601 005	UNION TAIL PIECE 1 5/16" DIA.	\$16.70
601 010	SPACER BUSHINGS	\$11.50
601 016	1/2" BODY ASSEM	\$240.20
601 019	STEM HEAD RETAINER 1/2" R.A.	\$65.00
601 090	VALVE STOP REVERSE ACTING	\$42.60
601 091	VALVE STOP REVERSE ACTING	\$29.80
601 092	VALVE STOP REVERSE ACTING	\$32.70
601 093	VALVE STOP REVERSE ACTING	\$69.30
601004A	1/2" CHROME PLATED UNION NUT	\$39.60
601004G	UNION NUT BRIGHT CHROME 1/2"	\$64.60
602 004	UNION NUT FOR 3/4" VALVE R.A	\$26.80
602 005	UNION TAIL PIECE 3/4" VALVE	\$23.10
603 003	1" POPPET	\$235.50
603 012	STEM HEAD RETAINER BALANCED VALVES	\$5.30
604 003	POPPET	\$251.20
605 003	POPPET	\$251.20
609 003	UNION TAIL PIECE 1" BALANCED VALVES	\$49.20
609 004	UNION NUT 1" BALANCED VALVES	\$39.60
609 009	SPACER BUSHING	\$13.20
609 019	SPACER BUSHING	\$13.20
609 021	SPACER BUSHING	\$42.60
609019A	SPACER BUSHING	\$8.60
609019B	SPACER BUSHING	\$18.70
609019C	STOP SLEEVE	\$5.30
610 003	UNION TAIL PIECE 1-1/4" VALVE	\$69.10
610 004	UNION NUT 1-1/4" BAL. VALVE	\$69.30
611 003	UNION TAIL PIECE 1-1/2" VALVE	\$88.80
611 004	UNION NUT	\$71.40

A WATTS Brand

Part No.	Description	List Price	Part No.	Description	List Price
612 049	UPPER POPPET SEAT 2" BAL.VALVE	\$160.60	672 636	FR ACTUATOR STEM, DA, 1/4" TH'D	\$91.40
612 051	LOWER POPPET SEAT 2" BAL.VALVE	\$160.60	672 641	BEARING, STEM	\$5.30
612 100	STEM HEAD RETAINER	\$32.70	672 642	SPRING	\$13.20
628 008	LOCKNUT 1-3/8" HEX.VALVE BONNET	\$15.75	672 645	SPRING	\$40.40
653 002	DISC HOLDER	\$49.20	672 646	SPRING	\$40.40
653 003	DISC HOLDER	\$137.00	672 720	SCALE	\$22.70
653 004	DISC HOLDER	\$137.00	672 721	SCALE 3/4 STROKE	\$26.30
653 005	DISC HOLDER	\$142.30	672 722	SCALE	\$26.30
653 009	DISC 3 EPDM	\$244.50	672 724	YOKE (PAINTED & MACHINED)	\$105.30
653 062	DISK	\$71.40	672559A	FR II START POINT TAG N.O.	\$5.30
653 063	VALVE DISC 3/4" TEFLON	\$171.90	672560A	FR II START POINT TAG N.C.	\$5.30
653 064	DISC	\$151.90	672618E	STEM BUSHING	\$56.00
653 070	DISC 4"	NLA	672632A	TOP HOUSING	\$76.50
653 163	DISC	\$65.90	672633A	BOTTOM HOUSING PAINTED	\$70.50
653 164	DISC	47.10	672634A	FR ACTUATOR STEM, RA, 318 TH'D	NLA
653 212	3/4" TEFLON DISC	NLA	672636A	FR ACTUATOR STEM, RA, 1/4 TH'D	\$91.40
653 213	TEFLON VALVE DISC	\$146.00	672636C	STEM RA	\$113.40
653 214	1-1/4" TEFLON DISC	\$91.40	672638B	WASHER INDICATOR	\$5.30
653 215	TEFLON DISC	\$95.80	672639C	POSITIONER MTG. BRACKET	\$78.20
653 216	TEFLON DISC	\$93.90	672723A	SCALE	\$10.00
653 220	3/4" TEFLON DISC	\$53.80	675 026	HANDLE KIT	NLA
653 225	VALVE DISC, 3/4"	\$7.80	675 028	DIAPHRAGM/FILTER KIT	NLA
653 226	VALVE DISC, 1"	\$9.50	675 031	RETROFIT CARTRIDGE	NLA
653 227	VALVE DISC, 1-1/4"	\$10.90	675 034	FLANGE, 8" WIDESPREAD	\$31.30
653 228	VALVE DISC, 1-1/2"	\$14.60	675 036	CARTRIDGE	NLA
653 229	VALVE DISC, 2"	\$16.20	700 424	GAUGE DIAL	\$9.80
654 009	DISC RETAINER NUT	\$24.60	700 713	HOUSING, #11 REG	\$47.60
654 010	DISC RETAINER NUT	\$59.40	700128A	STEM EXTENSION	NLA
654 011	DISC RETAINER NUT	\$19.90	701 491	TANK FITTING ASSEMBLY	\$489.50
654 012	DISC RETAINER NUT	\$49.20	705 005	1" TANK FTG	\$30.70
654 016	STEM RETAINER	\$10.10	705 006	1-1/4" TANK FTG	\$128.40
654 017	STEM RETAINER	\$7.60	708 036	STEM HEAD RETAINER	\$32.70
654 019	STEM RETAINER	\$8.90	709 075	WELL ASSEMBLY	\$292.00
656 311	STEM HOLDER & DISC ASSEMBLY	\$282.50	709 128	WELL ASSEMBLY	NLA
656 527	CAP	\$59.50	709 166	BELLOWS STOP	\$5.30
656 528	3/4" VALVE CAP	\$49.20	740 018	DRIP PLUG	NLA
656 761	REBUILDING KIT	NLA	744 061	STOP PIN	\$5.30
672 110	SPRING	\$69.30	744 062	GUIDE BUSHING	\$5.30
672 111	SPRING	\$69.30	744 072	RESTRICTION SCREW	\$5.30
672 113	SPRING	\$69.30	744 075	VALVE SPRING	\$5.30
672 114	SPRING	\$69.30	744 078	ADJUSTING KNOB	\$13.20
672 136	COPPER SLUG	\$5.30	744 082	WELL ASSEMBLY	\$725.00
672 520	DIAPHRAGM FOR 12" ACTUATOR	NLA	744 083	GASKET	\$5.30
672 614	FR ACTUATOR STEM, DA, 3/8" TH'D	\$91.40	744 102	ACC KIT FOR ACCRITEM	\$158.30
672 615	FLOWRITE ACTUATOR LARGE SPRING	\$19.80	744 124	SPG RETAINING SCREW	\$5.30
672 626	DIAPHRAGM, ACTUATOR	\$109.20	744 131	VALVE SEAT	\$29.40
672 627	ACTUATOR THRUST PLATE	\$49.20	744 134	RESTRICTOR SCREW	\$56.00
672 634	FR ACTUATOR STEM, DA, 3/8" TH'D	\$91.40	744 151	LEVER	\$38.60

A WATTS Brand

Part No.	Description	List Price
744 154	LEVER PIVOT	\$5.30
744 163	VALVE	\$28.70
744 168	KIT	\$90.00
744 172	SENSITIVE TUBE ASSEMBLY	\$163.70
744 175	ADJUSTMENT SCREW	\$13.20
744 185	PLATE COVER JORDAN	\$38.60
744 191	SENSITIVE TUBE FOR SS ACCRITEM	\$634.10
744 202	BODY	\$148.20
744 205	COVER MOLDING	\$32.70
744 212	FOLLOWERS, POWER ELEMENT	\$8.60
744 213	VALVE SEAT	\$31.20
744 214	VALVE	\$39.60
744 215	SCREW, SPRING RETAINING	\$32.70
744 216	STEM, ADJUSTING	\$16.70
744 218	RESTRICTION SCREW	\$7.80
744 223	NAME PLATE	\$53.60
744 234	ADJ KNOB W/SCREW	\$26.80
744 254	ST BULB & CAP 7441272	\$815.20
744 283	SENSING ELEMENT, COPPER	\$162.40
744170D	COVER PLATE ASSM F&C	NLA
744262A	PICK NAME PLATE	\$32.90
744263A	PICK NAME PLATE	\$33.90
744263B	NAME PLATE, CELSIUS	\$32.70
800 005	BONNET	\$10.10
800 012	STEM ASSEMBLY, THROTTLING	\$7.70
800 020	GASKET	\$5.30
800 024	LIMIT STOP ASSEMBLY	\$27.60
800 030	SOFT COMPONENTS KIT	\$28.70
800 036	LEVER HANDLE KIT (1 SET)	\$38.10
800 040	FACEPLATE KIT, ROUND	\$95.50
800 050	WASHER	\$5.30
800 056	TEFLON GASKET	\$5.30
800 060	PLUNGER	\$5.30
800 061	PLUNGER DISC	\$5.30
800 063	O-RING	\$5.30
800 064	O-RING	\$5.30
800 075	COLOR INSERT FOR 800 ENGLISH	\$22.00
800 080	SCREW 8-32 X 3"	NLA
800 098	BILTMORE MODEL 1 & 2 REPAIR KIT W/LEVER	\$173.30
800 099	BILTMORE MODEL 1 & 2 REPAIR KIT W/KNOB	\$173.30
800 109	STEM EXT KIT FOR 800	\$60.10
800 110	STEM EXT.	\$22.60
800 162	SCREW WITH PATCH	\$5.30
800 163	VALVE REPAIR KIT, SERIES 800	\$105.70
800 164	SCREW 8-32 X 5/8" LG	\$5.30
800 167	SCREW W/PATCH	\$5.30
800 168	SCREW 8-32 W/PATCH	\$5.30
800 183	ROUND DIAL FOR 800 BILTMORE	\$100.40

Part No.	Description	List Price
800 185	REPLACEMENT KIT (BILTMORE)	\$22.70
800 200	KIT, 800 ACRYLIC HANDLE	\$68.60
800005BP	BONNET, QTY= 25	NLA
800005JP	BONNET, QTY= 100	\$507.00
800015H	SLEEVE, POLISHED CHROME PLATE	\$31.70
800015BH	SLEEVE, POLISHED BRASS	\$68.60
800020BP	GASKET, QTY= 25	\$87.20
800032A	BILTMORE 800 STEM/BON REPL KIT	\$70.50
800050BP	WASHER, QTY= 25	\$33.40
800058BP	O-RING, QTY= 25	\$20.70
800060BP	PLUNGER, QTY= 25	\$87.90
800063BP	O-RING, QTY= 25	\$23.60
800064BP	O-RING, QTY= 25	\$23.60
800080BP	SCREWS 8-30 X 3", QTY= 25	NLA
800164BP	SCREW W/PATCH BULK PACKED, QTY= 25	\$39.30
800164JP	SCREW, QTY= 500	\$672.50
800310C	INTERNAL BALANCE CHAMBER KIT	\$85.10
900 012	THROTTLING STEM ASSEMBLY	\$12.30
900 014	WASHER, MIXING PLATE	\$5.30
900 015	BONNET	\$5.40
900 026	SPRING STOP CHECK	\$5.30
900 028	SOFT COMPONENTS KIT, 900 MDL 3	\$29.80
900 030	REPAIR KIT SOFT COMPONENTS	\$29.80
900 031	900 BAL CHAMBER KIT MODEL 2	\$87.50
900 032	INTERNAL KIT	\$85.10
900 033	SPRING, STEM	\$5.30
900 035	KNOB	\$38.40
900 036	LEVER HANDLE, BILTMORE	\$45.70
900 040	ROUND FACEPLATE KIT	\$80.80
900 047	NUT "U" TYPE	\$5.30
900 049	CHECK STOP REPAIR KIT 900	\$58.00
900 050	CHECKSTOP KIT, 900 MODEL 3	\$58.00
900 068	ACRYLIC KNOB KIT, 900 MODEL 3	\$34.40
900 069	LEVER HANDLE KIT, 900 MODEL 3	\$45.70
900 070	LEVER HANDLE	\$41.70
900 075	CARTRIDGE PULLER	\$5.30
900 085	SHUT OFF DISC	\$5.30
900 090	TRIM PLATE, BRIGHT CHROME	\$18.00
900 091	HANDLE, BRIGHT CHROME PLATE	\$21.40
900 092	INSERT HANDLE	NLA
900 093	GASKET FOR SLEEVE	\$5.30
900 094	GASKET, TRIM PLATE	\$5.30
900 095	NAME PLATES, TRIM ENG W/CSA LOG	\$11.90
900 096	HANDLE BUTTON	\$5.30
900 102	FACEPLATE KIT, CHROME FINISH	\$70.50
900 103	HANDLE KIT, CHROME FINISH	NLA
900 105	HANDLE KIT, CHROME W/O STOP	\$49.80
900 107	HANDLE KIT WITHOUT STOP	\$45.70
900 108	KNOB KIT, ACRYLIC W/O STOP	\$34.40

A WATTS Brand

Part No.	Description	List Price
900 109	STEM EXTENSION KIT	\$51.50
900 118	FOR MILWAUKEE FAUCET	\$18.30
900 120	ROUGH IN GUIDE FOR 900	\$5.30
900 123	MOUNTING BRACKET	\$10.20
900 132	SLEEVE FOR 909/910 BILTMORE	\$17.10
900 140	PLUG BUTTON, SERIES 900	\$7.80
900 141	PLUG BUTTON, SERIES 410 & 420	\$5.30
900 149	STEM	NLA
900 152	DIVERTER ASSEMBLY, SWEAT	NLA
900 155	FACEPLATE KIT	NLA
900 156	NAME PLATE	NLA
900 174	CHAMBER REPAIR KIT CITADEL	NLA
900 190	DIVERTER HANDLE KIT	NLA
900 191	DIVERTER STEM KIT	NLA
900 197	OUTLET SEALS	\$5.30
900 216	SPRING, .300 O.D., .375 LG	\$5.30
900 219	BONNET	\$5.30
900 231	THROTTLING STEM ASSEMBLY	\$9.30
900 240	CHAMBER REPAIR KIT, BAL.MDL3	\$54.00
900 259	BALANCE CHAMBER ASSEMBLY KIT	\$54.00
900 268	SLEEVE KIT, LARGE	\$18.10
900 269	BILTMORE SLEEVE KIT FOR MODEL 3	\$35.70
900014BP	WASHER QTY= 25	\$39.30
900015A	BONNET ASSEMBLY	\$35.30

Part No.	Description	List Price
900015B	900 BONNET,MACHINED	\$14.20
900017A	BONNET NUT	\$21.40
900019BP	ACRYLIC KNOB, QTY= 15	\$487.20
900020A	DIAL ROUND W/CSA LOGO	\$71.40
900026JP	SPRING, QTY= 500	\$200.90
900029BP	LEVER HANDLE, QTY= 15	NLA
900031A	BAL CHAMBER REP KIT MODEL 1	\$108.00
900033BP	SPRING, QTY= 25	\$82.30
900059JP	STEM, QTY= 250	\$494.70
900085BP	SHUT OFF DISC QTY= 25	\$55.10
900085JP	SHUTOFF DISC, QTY= 500	\$906.80
900090K	TRIM KIT (900 W/DIV)	NLA
900092BP	HANDLE INSERT QTY= 25	NLA
900093BP	GASKET, QTY= 25	\$89.30
900094BP	GASKET, QTY= 25	\$89.30
900095BP	NAME PLATE, QTY= 25	\$232.00
900096BP	HANDLE BUTTON BP. QTY= 25	\$39.30
900140BP	PLUG BUTTON, SERIES 900 PKG, QTY= 25	NLA
900140JP	BUTTON & INSERT, QTY= 250	\$647.30
975 130	CARTRIDGE, REPLACEMENT	\$95.70
975 181	4" WRIST LEVER HANDLE	\$122.80
975170A	1/2" VOLUME VALVE CONCEALED	\$335.70
SA12135	BONNET ASSEMBLY 428 HYDRO	NLA

IntelliStation™ Replacement Parts

Part No.	Description	List Price
81019060	CONTROLLER	\$724.00
81019061	TEMPERATURE SENSOR W/WIRE	\$23.30
81019285	1 1/2 INCH 3-WAY VALVE	\$538.10
81019286	2 INCH 3-WAY VALVE	\$851.20
81019287	ACTUATOR	\$1050.80
81019288	PRESSURE SENSOR W/WIRE	\$227.20
81019289	HIGH-SPEED TEMPERATURE SENSOR W/WIRE	\$57.40

A WATTS Brand

Part No.	Description	List Price
008 802	ST STL TUBING MAX LENGTH 160FT	NLA
030 011	SCREW, FIL, HD, BR	NLA
030 063	SCREW, BRASS 8-32 X 3/4"	NLA
030 107	SCREW	R/B 080 058
030 190	SCREW 0-80 X 1/8" LENGTH	NLA
030104B	FIL HD BR SCREW	NLA*
032271K	SCREW	R/B 080 008
032281K	SCREW	NLA
034 042	SCREW	NLA
034 063	BINDER HD BR SCREW	NLA
034106KBP	SCREW, 4-40 X 1" LG	NLA
034218G	SCREW	R/B 450 271
034222G	SCREW	R/B 034223G
034224GJP	SCREW, QTY= 500	NLA
035120K	CAP SCREW	NLA
035208G	BOLT 3/8-16 X 2-1/2" W/OUT NUT	NLA
041 132	NUT	R/B 041132GBP
041235J	NUT, LOCK 5/8-18 STEEL	NLA
042 520	NIPPLE	R/B 410 437
043 212	BUSHING	R/B 410 437
043 340	PLUG	NLA
043 834	VACUUM BREAKER, 1/2" NPT BOTTOM INLET	NLA
046 168	WASHER	NLA
046 171	WASHER, 7/8 X 13/64 BRASS	NLA
046021K	WASHER, SHAKEPROOF	NLA
047 009	O-RING	R/B 047 020
047 030	O-RING (N45) 1 3/4 X 2 X 1/8	NLA
047 205	RING, RETAINING - BERYLLIUM CU	NLA
047 210	SPIRAL RETAINING RING	NLA
047009BP	O-RING KIT	R/B 410 366
047009JP	O-RING KIT	R/B 047020JP
047052J	RETAINING RING	NLA
047061J	RING, RETAINING	NLA
047131BP	O-RING	NLA
047131JP	O-RING	NLA
080 001	SCREW	R/B 450 271
080 002	SCREW	R/B 450 273
080 012	SCREW	R/B 420 267
080 069	SCREW KIT, VANDAL PROOF	NLA
081 011	NUT, 9" FLOWRITE	NLA
080012A	SCREW	R/B 080 041
084 028	O-RING	NLA
089 008	SPANNER DRIVER SIZE 8	NLA
100 016	FLAPPER, RIGHT HAND	NLA
100 431	PINION	NLA
115 069	BODY	R/B 594 477
115 071	VALVE BODY	R/B 591 719
115 073	BODY	R/B 594 500
131 274	AMER. LOCK W/KEYS FOR CABINETS	NLA
131 387	BALL VALVE	R/B 132 692

NLA - No Longer Available

Part No.	Description	List Price
131387A	BALL VALVE	R/B 132692A
131387B	BALL VALVE	R/B 132692B
132 760	CABINET	NLA
141 327	PROF. VINLY HOSE, 40" GLIDE RAIL, PUSH BUTTON	NLA
141 387	COMPRESSION RING, HI/CARB STEEL	NLA
141 761	DELUXE 69" METAL HOSE, 24" GLIDE RAIL	NLA
141 805	DUBL BARB CONNECTOR	NLA
141 819	ELBOW W/FLANGE BRASS	R/B 141 320
141 840	DELUXE METAL HOSE, 40" GLIDE RAIL	NLA
141 845	CHECKSTOP PLUNGER KIT TEFLON	R/B 141 000
141 869	PROF. METAL HOSE, 40" GLIDE RAIL	NLA
141 880	DELUXE, METAL HOSE, 24" WALL BAR	R/B141 163
141381H	INSERT KIT	NLA
141741B	SPINDLE	R/B 141 741
1420426	GAUGE, PRESSURE	R/B 1420373
147 116	SPRING KIT (1" & ABOVE TRAVEL)	NLA
147 118	POSITIONER DIAPHRAGM	NLA
147 119	POSITIONER HARDWARE KIT	NLA
147 123	VALVE PLUG	NLA
147116A	SPRING BAUMANN 71486 44 SPLIT	R/B 147 116
147301F	MOUNTING KIT	NLA
160 039	LOCK SCREW	NLA
181 338	COIL	NLA
225 045	BAFFLE CYLINDER	NLA
225 137	RING	NLA
225 258	BONNET	R/B 225 419
225 286	BODY CASTING RH	R/B 225 444
225 372	MOTOR ASSEMBLY	R/B 225 395
225 382	DISC HOLDER	R/B 225 433
225 383	SCREW	R/B 225 432/443
225 390	H MIXER KIT 10 GAL. 65/115F.	R/B 427 200/201/202
225 391	H MIXER KIT 5 GAL. 65/115F.	R/B 427 200/201/202
225 394	H CYLINDER & VALVE RPLCMT KIT	R/B 427 200/201/202
225 395	H MOTOR REPLACEMENT KIT M3	R/B 427 200
225 396	H MOTOR REPLACEMENT KIT M3	R/B 427 202
225 397	H MOTOR REPLACEMENT KIT M3	R/B 427 201
225 403	PACKING GLAND	R/B 225 450
225 419	BONNET	R/B 225419N
225051G	PACKING GLAND	R/B 225 450
225286G	BODY	R/B 225 445
227 038	COMBINATION SEAT	R/B 227038A
227 039	COMBINATION SEAT	R/B 227039A
227 049	MOTOR STEM	NLA
227 050	SHUT OFF DISC RTNR	R/B 420 220
227 157	DIAL INSERT	R/B 420 237
227 173	STEM SLEEVE	R/B 420 256
227 187	STOP RING	R/B 420 221
227 190	SPACER, SLEEVE	R/B 420 223
227 192	PACKING RING	NLA
227 195	KNOB KIT	R/B 420 481

R/B - Replaced By

A WATTS Brand

Part No.	Description	List Price
227 161	KNOB INSERT	NLA
227 290	VALVE & HOT WATER SEAT KIT	R/B 420 451/616
227 338	HYDRO DISC REPL KIT	NLA
227 339	MOTOR REPLACEMENT KIT 65-115°F	R/B 420 451/616
227 340	VALVE & H WATER SEAT	R/B 420 451/616
227 341	COMB SEAT REPL KIT	R/B 420 451/616
227 342	MOTOR REPL KIT 120-175°F	R/B 420451H/616H
227 343	MOTOR REPL KIT 40-90°F	R/B 420451L/451L
227 344	TAMPER PROOF CAP ASY	NLA
227 346	END PLATE	NLA
227 377	BONNET REPAIR KIT	R/B 420 451/616
227 351	SEAT	R/B 420 452/616
227063BP	HOT WTR DISC, QTY= 25	NLA
227192BP	PKG RING 25 PCS TO KIT	NLA
227 430	PLG.BUTN.	R/B 420 225
227 431	VALVE KIT	R/B 420 556
227 445	VALVE KIT	R/B 420 555
227 561	SHUTTLE & HW SEAT	R/B 420 451/616
227038A	COMBINATION SEAT	NLA
227039A	COMBINATION SEAT	NLA
227206BP	SHUTOFF DISC, QTY= 25	NLA
227233BP	SPACER RING BULK 25/KIT	NLA
227339JJP	VALVE ASSEMBLY, QTY= 200	R/B 420 451JJP
227340JJP	VALVE HOT WATER SEATS, QTY= 200	R/B 420 451JJP
227341JJP	COMBINATION SEAT, QTY= 200	R/B 420 451JJP
227430BP	PLUG BUTTON	R/B 227 164
230 041	CHECKSTOP LH 1/2" BRT CHROME	R/B 230 042
230 047	CHECKSTOP ANGLED 1/2" IPS BRT CHROME	R/B 230 048
230 060	GASKET	R/B 230 065
230 076	BONNET	R/B 230076A
230 077	BONNET	R/B 230077A
230 078	BONNET	R/B 230078A
230 080	STEM	NLA
230 096	UNION NUT	NLA
230 120	TAIL PIECE	NLA
230 128	1/2" TRIPLE DUTY C	NLA
230 154	CHECK STOP LEFT HAND PC	NLA
230 190	LT. HAND CHECK STOP BODY	NLA
230 196	BODY CASTING RH	R/B 230 146
230 199	BODY, LEFT HAND (PLAIN)	NLA
230 217	BODY 3/4" CHECK STOP	NLA
230 290	STEM ASSEMBLY POLISH CHROME	NLA
230 329	BONNET KIT 1/2" TD POL CHR	NLA
230 330	BONNET KIT 1/2" TD RGH BRZ	NLA
230 335	CHECKSTOP REPAIR KIT SPECIAL	R/B 141 000
230 305	PLUNGER DISC	NLA
230336BP	SPRING KIT, QTY= 25	NLA
230077A	BONNET	NLA
230 262M	3/4" POLYCHROME CHECK STOP	NLA
331 077	DIAPHRAGM	R/B 331077A
390 052	GASKET, FLANGE	NLA

NLA - No Longer Available

(Prices Effective 10/08/18)

Part No.	Description	List Price
390 193	SPRING ASSEM OVER TRAVEL	R/B 390 512
390 288	SCREEN REPLACEMENT KIT	NLA
390 290	N 125 HYDRO GASKET K	NLA
390 292	DISC	NLA
390 295	431 MOTOR KIT	R/B 390 016
390 296	431 MOTOR KIT	R/B 390 016
390 297	431 POPPET KIT	R/B 390 067
390 299	432 MOTOR KIT	R/B 390 017
390 300	432 MOTOR KIT	R/B 390 017
390 301	POPPET KIT	R/B 390 466
390 303	433 MOTOR KIT	R/B 390 511
390 304	433 MOTOR KIT	R/B 390 511
390 307	434 MOTOR KIT	R/B 390 512
390 308	434 MOTOR KIT	R/B 390 512
390 310	CROSS HANDLE AND ADJ. KIT	NLA
390 329	431 MOTOR KIT	R/B 390 016
390 330	432 MOTOR KIT	R/B 390 017
390 331	433 MOTOR KIT	R/B 390 511
390 332	434 MOTOR KIT	R/B 390 512
390 338	ADJUSTMENT KNOB	NLA
390 339	ADJUSTMENT KNOB	NLA
390 461	POPPET	R/B 390 491
390 472	SOLDER RING	NLA
390075BP	POPPET, KIT	R/B 390483BP
390151BP	SPRING ASSEMBLY KIT	NLA
390151JP	SPRING ASSEMBLY KIT	NLA
390193JP	SPRING ASSEMBLY KIT	NLA
390239JP	SPRING ASSEMBLY KIT	NLA
390305N	POPPET KIT	NLA
390466N	432 POPPET KIT, AFTER FEB '91	NLA
390468N	434 POPPET KIT, AFTER FEB '91	NLA
390491BP	POPPET, QTY= 5	NLA
400022BP	SPRING KIT	R/B 410427BP
401 120	DIVERTER KNOB	NLA
401 173	DIAL ASSEMBLY	R/B 401173A
401 205	STEM	NLA
401 206	STEM EXT.	NLA
401 228	ADJ. STOP	R/B 401 278
401 232	CHAMBER	R/B 410 330
401 272	DIAL KIT	NLA
401165BP	MAX. TEMP. STOP BULK 25/KIT	NLA
401173A	DIAL ASSY.	NLA
401228BP	STOP KIT	R/B 401278BP
403 004	PACKING GLAND	NLA
410 144	WASHER	R/B 410 368
410 161	DIAL	R/B 410 414
410 163	LEVER ASSEMBLY	R/B 410 415
410 168	GASKET	R/B 410 284
410 360	HANDLE	NLA
410 373	GASKET KIT	R/B 410284BP
410 387	KNOB	R/B 410 383

R/B - Replaced By

A WATTS Brand

Part No.	Description	List Price
410 388	CONVERSION KIT	R/B 410 384
410168BP	GASKET KIT	R/B 410284BP
420 106	KNEE PLATE ASY	NLA
420 140	ASSEMBLY,CARTRIDGE	R/B 420 452
420 153	VALVE ASSEMBLY	R/B 420 034
420 155	SEAT, HOT WATER (HI CAPACITY)	NLA
420 156	SEAT, STANDARD CAP. HOT WATER	NLA
420 161	BONNET REPAIR KIT	R/B 420 451/616
420 184	STEM	R/B 420184A
420 193	VALVE ASSEMBLY	NLA
420 195	OVER RIDE STEM	NLA
420 200	BONNET	R/B 420 209
420 201	BONNET	R/B 420 208
420 203	420 CONV KIT FOR 110F SUPPLY	R/B 420 451/616
420 209	BONNET, MACHINED	NLA
420 219	SCREW KIT, LUCITE SCREW (20)	NLA
420 220	SHUT OFF DISC RET. KIT (6)	NLA
420 221	PACKING STOP RING KIT (5)	NLA
420 223	TEMP STOP SPACER KIT (12)	NLA
420 224	NAME PLATE	NLA
420 227	420 CONV. KIT	RB 420 451/616
420 250	HOT WATER SEAT	R/B 420250A
420 256	STEM SLEEVE	NLA
420 265	STOP RING, PACKING	NLA
420 304	420 BDY ASSY	R/B 420 143
420 305	PACKING GLAND	R/B 420 578
420 321	420 VALVE ASSY 4 PORT	R/B 420 128
420 343	STEM, UTC ROUGH CHROME	NLA
420 441	440 BODY ASSEMBLY	R/B 420 143
420 444	KIT, CARTRIDGE, W/RUBBER SEAT	RB 420 034
420 449	440 FOTOGUARD BODY ASSY	R/B e420 449
420 450	440 BODY ASY BR CHR MD7	R/B e420 450
420 461	420 BODY ASSEMBLY MD 7	R/B 420 143
420 464	HYDROGUARD ASSEMBLY MODEL 8	R/B 420 153
420 470	SEAT ASSEMBLY. H.W COMB 110°F.	NLA
420 498	MOTOR, THERMOSTATIC 65/115°F	NLA
420 499	MOTOR THERMOSTATIC 120 175	NLA
420 519	MOTOR KIT UNDER COUNTER MIXER	R/B 420 611/615
420 520	COMBINATION SEAT KIT	R/B 420 559
420 522	COMBINATION SEAT KIT 1 GALLON	NLA
420 525	VALVE ASSEMBLY KIT STD CAPACITY	NLA
420 531	HYDROGUARD BODY ASSEM	R/B 420 534
420 555	VALVE KIT & H/W SEAT 3 GPM	R/B 420 451/616
420 556	VALVE KIT & HW/COMB H CAP	R/B 420451C/616C
420 557	VALVE KIT HW/COMB SEAT H CAP	R/B 420 451/611
420 558	KIT, COMB STD/HI CAP	R/B 420 451/616
420 559	KIT COMBO SEAT HI TECH	R/B 420611C/615C
420 560	KIT, VALVE ASSY STD/LO CAP UTC	NLA
420 561	KIT, VALVE & HW SEAT STD CAP	NLA
420 562	KIT, INTERNAL REBUILD 5 9	R/B 420 451/616

Part No.	Description	List Price
420 563	VALVE ASSY, KIT	NLA
420 580	VALVE & HOT WATER SEAT	NLA
420 615	UPGRADE KIT, UTC, STD. TEMP	NLA
420122BP	ADJUSTMENT STEM QTY= 15	NLA
20122JP	ADJUSTMENT STEM QTY= 50	NLA
420155BP	HOT WATER SEAT, QTY= 15	NLA
420155JP	HOT WATER SEAT QTY= 25	NLA
420184H	ADJUSTMENT STEM	NLA
420200A	BONNET	R/B 420 209
420200ABP	BONNET	R/B 420209BP
420200JP	BONNET	NLA
420201A	BONNET	R/B 420 208
420209BP	BONNET, QTY= 15	NLA
420250A	HOT WATER SEAT	NLA
420305BP	GLAND KIT	NLA
420305JP	420 GLAND KIT	NLA
420470BP	COMBINATION SEAT QTY= 5	NLA
420470JP	COMBINATION SEAT (10)	NLA
420519V	MOTOR KIT HIGH TEMP	NLA
420519W	MOTOR KIT LOW TEMP	R/B 420 615L
420611C	420 UTC UPGRADE KIT	NLA
420611H	420 UTC, UPGRADE KIT, HIGH TEMP.	NLA
420615H	UPGRADE KIT, UTC, HIGH TEMP.	NLA
420616C	UPGRADE KIT, HIGH CAP.	NLA
430 018	ADJ LOCK SCREW KIT 430 (8)	NLA
430 019	SCREW TRI HANDLE (2)	NLA
433004G	PACKING GLAND NUT	NLA
435 038	VALVE KIT	NLA
436 088	HANDLE	NLA
440 182	CABINET	NLA
440 186	BRACKET	R/B 440 234
440 208	DIAL ASSY	NLA
440 236	BRAIDED CONNECTOR	NLA
4402000	FOTOPANEL	R/B 4401000
4402019	FOTOPANEL	R/B 4401020
4420184A	ADJ STEM FOR 420 HYDRO	NLA
444 115	MICROPHONE & ENC.	DISC.
444 143	SHOWER INST. KIT	NLA
444 153	"H" PANEL INFRARED SENSOR	NLA
445 107	OUTLET SHUT OFF DISC ASSEMBLY	NLA
445 113	STEM	NLA
445 114	STEAM SEAT	NLA
445 116	DISC HOLDER	NLA
445 117	ADAPTER	NLA
445 118	CARTRIDGE SPRING	NLA
445 119	RETAINING WASHER	NLA
445 121	STEAM DIFFUSER	NLA
445 124	LIMIT STOP	NLA
4451000	STEAM AND WATER MIXER RGM BRZ	NLA
4451001	STEAM AND WATER MIXER BRT CHR	NLA

NLA - No Longer Available

R/B - Replaced By

A WATTS Brand

Part No.	Description	List Price	Part No.	Description	List Price
450 154	COUPLING	NLA	591 758	BODY	R/B 594 478
450 169	COVER PLATE	NLA	591 761	BONNET	R/B 594 467
450 192	SLEEVE	R/B 450192RK	591 763	BONNET	R/B 594 479
450 451	TUBE	NLA	591 764	BONNET	R/B 594 459
4504014	CORNER MOUNTING BRACKETS	R/B 4500430	591729A	STEM HEAD RETAINER KIT	NLA
460 011	IND CIR BD ASSEMBLY W/TERM	NLA	591814F	STEM EXTENSION	NLA
460 014	SWITCH, 3 POSITION TOGGLE	NLA	591814H	STEM EXTENSION	NLA
460 015	SWITCH ASSEMBLY TOGGLE	NLA	591814J	STEM EXTENSION	NLA
460 029	MOTOR FOR SHOWER TROL	NLA	591814K	STEM EXTENSION	NLA
460 031	CLUTCH SPRING SHOWER TROL	NLA	591815A	STEM EXTENSION	NLA
460 038	CAPACITOR	NLA	591 818	STEM EXTENSION	R/B 594818A
460 045	ADJ. STOP	NLA	591 819	STEM EXTENSION	R/B 594 819
460 067	TOGGLE SWITCH ASSEMBLY	NLA	591 906	WASHER WAVY	NLA
460 136	PLATE, FRONT FOR SHOWER TROL	NLA	591 908	NUT RA	NLA
460 145	BLANK SWITCH PLATE	NLA	591 917	2" RA NUT	NLA
490 020	LOWERS ASSY STD RANGE 90° - 120°F	NLA	591 967	VALVE REBUILD/REPACK KIT	NLA
490 027	LOWER ASSY WIDE RANGE 110° - 145°F	NLA	591813A	STEM EXTENSION	R/B 594813A
490 028	LOWER ASSY HIGH RANGE 80° - 160°F	NLA	591817A	STEM EXTENSION	R/B 594817A
590 137	BONNET ASSEMBLY	R/B 594 499	591817B	STEM EXTENSION	R/B 594817D
590 143	BONNET	R/B 594 481	591817C	STEM EXTENSION	R/B 594817D
590 146	BONNET	R/B 594 456	591817D	STEM EXTENSION	R/B 594817D
590 166	CUP, GREASE	NLA	591818A	STEM EXTENSION	R/B 594818A
590 405	LOCKNUT	NLA	591843B	STEM	NLA
590 431	THROTTLING DISC	NLA	593002F	MTG.KIT I/P & POS., 46" ACT.	NLA
590 440	VALVE CAP	NLA	593003E	MTG.KIT I/P & POS., 46" ACT.	NLA
590 576	POPPET	NLA	594 011	VALVE ASSEMBLY	NLA
590 577	POPPET	NLA	594 082	STEM EXTENSION	R/B 594 570
590 578	POPPET	NLA	594 083	STEM EXTENSION	R/B 594 571
590 579	POPPET	NLA	594 084	STEM EXTENSION	R/B 594 572
590 582	POPPET	NLA	594 086	STEM EXTENSION	R/B 594 550
590 586	BODY	R/B 594 506	594 087	STEM EXTENSION	R/B 594 551
590 603	LOCK PIN	NLA	594 093	STEM EXTENSION	R/B 594 574
590 670	BODY	R/B 594 504	594 094	STEM EXTENSION	R/B 594 575
590 672	BODY	R/B 594 505	594 095	VALVE STEM	R/B 594 558
590 679	CAP	R/B 594 458	594 096	STEM EXTENSION	R/B 594 559
590 681	SEAT	R/B 594 459	594 097	STEM EXTENSION	R/B 594 560
590 686	VALVE CAP	R/B 594 470	594 130	VALVE SEAT	R/B 594 568
590 750	VALVE CAP	R/B 594 513	594 141	1-1/2" VALVE SEAT	NLA
590 766	PACKING SPACER	NLA	594 207	VALVE STEM	R/B 594 566
590 773	RING	R/B 594 081	594 210	SPRING	NLA
590 817	YOKE/BRIDGE	R/B 594 515	594 295	VALVE SEAT	NLA
590 916	SEAT	R/B 594 474	594 369	DISC	NLA
590808A	STEM EXTENSION	R/B 590808B	594 458	VALVE CAP	NLA
591 502	V RING PKG. KIT (1 SET)	NLA	594 459	VALVE SEAT 2"	NLA
591 693	DISC ASSEMBLY 4"	NLA	594 517	YOKE #11 3 WAY REGULATOR	NLA
591 719	VALVE BODY	NLA	594517A	YOKE	R/B 594 517
591 701	BODY ASSY	R/B 594 489	594 560	2" STEM NORMALLY OPEN	NLA
591 729	RETAINER, STEM HEAD	R/B 591729A	594 573	N.O. VALVE STEM ASSEMBLY	NLA
591 751	BODY	R/B 591 732	595 517	PART KIT	NLA
591 752	BODY	R/B 591 733	601005G	UNION TAIL PC	NLA

NLA - No Longer Available

R/B - Replaced By

(Prices Effective 10/08/18)

A WATTS Brand

Part No.	Description	List Price
604 002	CAP	R/B 591 781
612 055	GASKET	NLA
612 060	POPPET	R/B 594 354/817A
632 004	GASKET	NLA
632 005	GASKET	NLA
633 005	GASKET	NLA
653 068	DISC	NLA
653 069	DISC	NLA
653 160	DISC	R/B 653 062
653 160	DISC	R/B 653 062
653 162	DISC	R/B 653 064
653 166	DISC	R/B 653 068
653 167	DISC	R/B 653 069
653 169	DISC	R/B 591 693
653 172	DISC	NLA
653 198	DISC	R/B 653 226
653 199	DISC	R/B 653 227
653 203	DISC	R/B 653 009
656 511	DISC	NLA
656 740	DISC KIT (10)	NLA
657 220	PLUG	NLA
657 552	DISC	R/B 656 740
657 796	DIAPHRAGM	NLA
672 102	RUBBER DIAPHRAGM	NLA
672 141	HOUSING	NLA
672 145	SCREW	NLA
672 294	SPRING	NLA
672 295	SPRING	NLA
672 365	8" HVY DUTY VALVE DIAPHRAGM	NLA
672 419	STEM	R/B 672 557
672 420	STEM	NLA
672 430	SPRING	NLA
672 436	THRUST WASHER	NLA
672 437	THRUST BEARING RETAINER	NLA
672 557	PLATE & STEM	NLA
672 558	PLATE & STEM	NLA
672 610	YOKE	R/B 672 724
672 625	FLOWRITE II ACTUATOR H/W KIT	NLA
672 632	TOP HOUSING	NLA
672 633	HOUSING	R/B 672633A
672 635	SPRING	R/B 672 642
672 637	POSITION INDICATOR	R/B 672723A
672 640	I/P MTG BRACKET	NLA
672 725	YOKE	NLA
672 614B	STEM	NLA
672 634A	STEM	NLA
672636B	STEM D.A.	NLA
700 125	BRIDGE ASSEMBLY	NLA
700 317	SLEEVE	NLA
700 804	SPRING SEAT	NLA

Part No.	Description	List Price
700 920	SAFETY TYPE PISTON PLATE ASSEMBLY	NLA
703023A	YOKE	R/B 594 517
703 040	ADJ NUT ASSEMBLY	NLA
709 167	HOUSING	R/B 700 713
744 063	SEAT	R/B 744 131
744 155	VALVE	R/B 744 163
744 170	COVER PLATE	R/B 744170D
744 184	ACCRIEM COVER PLATE JORDAN	NLA
744 204	LEVER	R/B 744 151
744 235	SENSING ELEMENT	R/B 744 283
800 015	SLEEVE	R/B 800015H
800 034	SCREW KIT	NLA
800 035	CRYSTAL KNOB KIT	R/B 800 200
800 041	OCTAGONAL ESCUTCHEON	NLA
800 044	BONNET KIT	R/B 800032A
800 049	CHECK STOP	R/B 900 049
800 067	SCREW	NLA
800 078	DIAL	NLA
800 144	INSERT FOR LUCITE HANDLE	NLA
808 517	DUCT FLANGE	NLA
800015B	SLEEVE	NLA
800036B	HANDLE	NLA
800080B	P.B. SCREW	NLA
800098A	REPAIR KIT	R/B 800 098
800099A	KIT	R/B 800 099
8943924	BLACK DIAL, 1-7/8" BULB	NLA
900 010	OCTAGON FACE PLATE	NLA
900 017	BONNET NUT	R/B 900017A
900 019	KNOB	R/B 900 035
900 020	DIAL	R/B 900020A
900 027	O-RING	R/B 800 056
900 029	HANDLE	R/B 900 107
900 039	SCREW	R/B 080 026
900 041	FACEPLATE KIT, OCT.	NLA
900 042	FACEPLATE	NLA
900 044	FACEPLATE	NLA
900 078	DIAL	NLA
900 101	HARDWARE KIT	R/B 900 102/103
900 137	NAME PLATE	NLA
900 165	FACEPLATE, KIT	NLA
900 192	DIVERTER O-RING KIT	NLA
900020K	FACEPLATE W/DIVERTER FOR 929H	NLA
900024A	BUTTON INSERT	R/B 900 140
900024CBP	PLUG BUTTON KIT	R/B 900140BP
900121A	REMODELING PLATE, CHROME-PLATED	R/B 900 121
981 496	SENSITIVITY TUBE	NLA

NLA - No Longer Available

R/B - Replaced By

To locate your nearest Powers representative, please click on our *FIND A REP* locator on PowersControls.com

Represented by:



POWERS™

A WATTS Brand

USA: T: (800) 669-5430 • F: (847) 229-0526 • PowersControls.com

Canada: T: (905) 332-4090 • F: (905) 332-7068 • PowersControls.ca

Latin America: T: (52) 81-1001-8600 • PowersControls.com