

Canadian Price List

Leader in Water Tempering Technology Since 1891

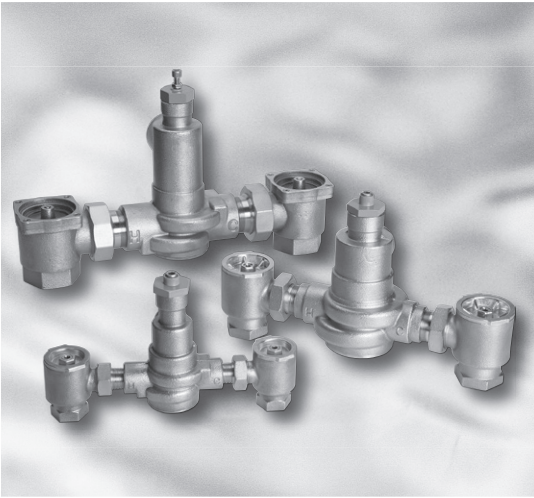

Effective Date August 6, 2018

All prices supersede previous issues, are temporary and subject to change without notice.

Standard Terms and Conditions of Sale	2-3	Accessories	
Pressure Balancing Valves		High Temperature Shutoff Device	33
Series 900 Blitmore®	4	Checkstops	33
Series PB410 HydroGuard®	6-7	Showerheads	33
PressureGuard®	6	Institutional Showerheads	33
Combination T/P Bath, Shower and Lavatory Valves		Arm/Flange Kits	34
HydroGuard® T/P Series e700	5	Hand Showers	34
VisuGuard® Series F727 and C727	8	Tub Spouts	35
HydroGuard® T/P Series e423 Valves	9	Diverter	35
HydroGuard® T/P Series e420	9-10	Vacuum Breakers	35
HydroGuard® T/P Series e427/e428	11	Volume Control Valves	35
Thermostatic Lavatory Valves		Dial Thermometers	35
TempTap™ Faucet	12	Metering Valve Shower	35
HydroGuard® Series LFe480	13	Self Operating Regulators	
HydroGuard® Series LFLM490/LFLM490-10	13	#11 Complete Regulators	36
HydroGuard® Series LFLM495	14	#11 Lower Housing Assemblies	36
Thermostatic Master Mixing Valves		#11 Thermal Systems and Accessories	37
HydroGuard®XP Series LFMM430 & Supply Fixtures	15-16	Flowrite® Valves and Accessories	
HydroGuard®XP Series LFSH1430 & Supply Fixtures	17	Heavy Duty Bronze Series Flowrite® Valves and Accessories	38-39
The Lead Free Tempering Re-circulation Loop	18	Heavy Duty Iron Series Flowrite® Valves and Accessories	40-41
HydroGuard®XP Series LFMM430 & LFSH1430 HiLo Supply Fixtures	19	Flowrite II Unmounted Valve Accessories	42
HydroGuard®XP High Capacity Systems Series LFSH1430	20	Accritem® Controllers and Accessories	43
IntelliStation™	21	Parts	44-50
POWERSTATION™			
Single-Valve Lead Free	22		
Multi-Valve Lead Free	23		
Emergency Tempering Valves, HydroGuard® ES/ETV Series	24-25		
Hydropanel II Modular Systems			
With e700 Valves	26		
With 900, PB410 and e420 Valves	27-28		
HydroGuard® ESP™			
Showers	29		
Shower Systems (Hydropanel II ESP)	30		
Alarm Systems			
Lead Free AquaSentry®2 Series LF460	31		
Thermostatic Specialty Valves			
Fotoguard	32		
Fotopanel	32		

A WATTS Brand

Freight Terms: All shipments are F.O.B. shipping point. Shipments from the factory of less than 500 lbs or \$3,500.00 net are F.O.B. factory. Factory shipments over 500 lbs, \$7,000.00 list or \$3,500.00 net will be prepaid and allowed within Canada when made at the lowest motor carrier transportation rate. Short-shipments and/or damaged goods must be reported within 72 hours.

Terms of Sale: All sales are F.O.B. shipping point.

Payment Terms: Invoices are due and payable 30 days from the date of invoice.

Purchase Order Forms: Orders submitted on the Purchaser's own purchase order forms will be accepted only with the express understanding that no statements, clauses or conditions contained in said order form will be binding on the Seller if they in any way modify the Seller's own terms and conditions of sales.

Minimum Order Requirements: A minimum billing charge of \$75.00 applies to shipments F.O.B. factory.

Special Products: Orders for special or modified products are non-cancelable. In the event that the customer cancels an order for such products, Watts shall charge the customer an amount equal to Watts' costs and expenses incurred in performing the purchase order prior to receipt of notice of cancellation.

Partial Shipment: The Seller reserves the right to make partial shipments from time to time and render invoices therefor which shall be due and payable in accordance with stated payment terms.

Delays: The Seller shall not be liable for any loss, damage, or delay occasioned by any causes beyond the Seller's control, including, but not limited to governmental actions or orders, embargoes, strikes, differences with workmen, fires, floods, accidents, or transportation delays.

Rejection of Shipments: If the Purchaser is unable or unwilling to accept any shipment, the Purchaser shall be liable to the Seller, in addition to any other rights to which the Seller may be entitled, for freight, express, storage, extra cost of handling, and other expenses incurred thereby.

Taxes: The amount of any present or future sales, use, occupancy, excise, or other tax, federal, province or local, which the Seller now, or hereafter shall be legally obligated to pay, either on its own behalf or on behalf of the Purchaser or otherwise, with respect to the material covered by this order or contract, shall (unless the prices contained herein are stated expressly to include such tax) be added to such prices and paid by the Purchaser. Purchaser agrees to report and pay any tax direct on non-exempt transaction, in case Seller's invoices do not indicate a charge therefor.

Limited Warranty: The Seller warrants each HydroGuard T/P e700 series valve to be free from defects in material and workmanship under normal usage for a period of one year from the date of original shipment. The Seller further warrants the internal tempering mechanism to be free from defects in material and workmanship under normal usage for a period of five years from the date of original shipment. The Seller warrants all other equipment manufactured by it to be free from defects in material and workmanship under normal usage for a period of one year from the date of original shipment. In the event of such defects within the applicable warranty period, the Seller will, at its option, repair or replace the product without charge.

The remedy described in the paragraph above shall constitute the sole and exclusive remedy for breach of warranty, and the Seller shall not be responsible for any incidental, special or consequential damages, including without limitation, lost profits or the cost of repairing or replacing other property which is damaged if the product does not work properly, damages or other costs resulting from labor charges, delays, vandalism, negligence, fouling caused by foreign material, damage from adverse water conditions, chemicals, decomposition by galvanic action, or any other circumstances over which the Seller has no control. This warranty shall be invalidated by any abuse, misuse, misapplication or improper installation of this product.

THE WARRANTY SET FORTH HEREIN IS GIVEN EXPRESSLY AND IS THE ONLY WARRANTY GIVEN BY THE SELLER WITH RESPECT TO THE PRODUCTS. THE SELLER MAKES NO OTHER WARRANTIES, EXPRESS OR IMPLIED. THE SELLER SPECIFICALLY DISCLAIMS ALL OTHER WARRANTIES, EXPRESS OR IMPLIED, INCLUDING BUT NOT LIMITED TO THE IMPLIED WARRANTIES OF MERCHANTABILITY AND FITNESS FOR A PARTICULAR PURPOSE.

Some provinces do not allow limitations on how long an implied warranty lasts, and some provinces do not allow the exclusion or limitation of incidental or consequential damages. Therefore the above limitations may not apply to you. This Limited Warranty gives you specific legal rights, and you may have other rights that vary from province to province. You should consult applicable laws to determine your rights. **SO FAR AS IS CONSISTENT WITH APPLICABLE PROVINCE LAW, ANY IMPLIED WARRANTIES THAT MAY NOT BE DISCLAIMED, INCLUDING THE IMPLIED WARRANTIES OF MERCHANTABILITY AND FITNESS FOR A PARTICULAR PURPOSE, ARE LIMITED IN DURATION TO ONE YEAR FROM THE DATE OF ORIGINAL SHIPMENT.**

Purchaser's Remedies: IN NO EVENT SHALL THE SELLER BE LIABLE, IN CONTRACT, TORT, STRICT LIABILITY, OR UNDER ANY OTHER LEGAL THEORY, FOR INCIDENTAL, INDIRECT, SPECIAL OR CONSEQUENTIAL DAMAGES, REGARDLESS OF WHETHER IT WAS INFORMED OF THE POSSIBILITY OF SUCH DAMAGES, AND IN NO EVENT SHALL THE SELLER'S LIABILITY EXCEED AN AMOUNT EQUAL TO THE SALES PRICE OF THE PRODUCTS. THE FOREGOING LIMITATIONS SHALL APPLY TO THE FULLEST EXTENT PERMITTED BY LAW.

Shortage Claims: Claims for shortage or incorrect filling of orders must be made within 15 days from the date of delivery.

Return Goods Policy: No material shall be returned without authorization. When credit is issued it will be at the price charged, or prevailing price if lower, less handling charges based on costs of reconditioning, boxing, etc. However, a minimum 25% handling charge will apply. A minimum handling charge of \$20.00 is applied whenever the 25% handling deduction does not total \$20.00. Products which are obsolete or made to special order are not returnable.

Returned Material Procedure: Customer Service will provide a Return Material Authorization (RMA) number, which must be written on all shipping label(s) of the returned material. Material received without an RMA number may be refused and returned to the sender at the sender's expense. When calling or faxing to request an RMA number, the following information will be necessary:

- Seller invoice number and/or sales order number
- Seller part number
- Seller product description
- Quantity of material to be returned
- Reason for return—be specific
- All returns must be shipped freight prepaid

All returned material is subject to inspection by the Seller and should be returned in original unopened shipping cartons or suitably packed to prevent damage in transit.

Customer Support:

For Customer Service: 1-888-208-8927; Monday through Friday, 8:00 AM to 5:00 PM EST. Fax number 1-888-479-2887.

For Technical Support: 1-800-208-8927; Monday through Friday, 8:00 AM to 5:00 PM CST. Fax number 1-888-479-2887.

Note: Prices and terms are subject to change without notice and supersede all previous quotations. The Seller reserves the right to change or modify product design or construction without prior notice and without incurring any obligation to make such changes and modifications on products previously or subsequently sold. Weights are not guaranteed but are shown only for the Purchaser's reference.

Governing Law: These terms and conditions shall be governed by, construed, and enforced in accordance with the laws of the Commonwealth of Massachusetts, without giving effect to its choice of law rules. All disputes under these terms and conditions shall be resolved exclusively by courts located in the Commonwealth of Massachusetts.







Special order and non-standard material is non-cancelable and not returnable.

ALL MTO PRODUCTS ARE NON-RETURNABLE

A WATTS Brand

All Series 900 Pressure Balancing Mixing Valves include integral check/service stops, adjustable handle rotation limit stop, reversible inlets for back-to-back installation, four-port connections, and reliable poppet/diaphragm cartridge construction.



	Description	Order Code	Weight	List Price
P902 	SS faceplate, metal lever handle. CP finish.			
	 1/2" copper sweat connections 1/2" IPS connections	P902H P902G	3.2 3.2	\$278.00 \$296.00
P905 	ABS faceplate with color-coded graphics, lever handle. CP finish.			
	 1/2" copper sweat connections 1/2" IPS connections	P905H P905G	3.0 3.0	\$235.00 \$252.00
P909 	ABS faceplate with color-coded graphics, acrylic handle. CP finish.			
	1/2" copper sweat connections 1/2" IPS connections	P909H P909G	3.0 3.0	\$262.00 \$249.00
P910 	ABS faceplate with color-coded graphics, metal lever handle. CP finish.			
	 1/2" copper sweat connections 1/2" IPS connections	P910H P910G	3.0 3.0	\$255.00 \$271.00

**To order complete Series 900 systems:
Valves**

See above for selection of valve order code

P

	List Price	Weight (lbs)	Order Code
Showerheads, Arm and flange			
Economizer, Chrome-Plated ABS, Arm & Flange	\$52.00	0.8	J1
Standard Chrome-Plated Brass, Arm & Flange	\$85.00	1.2	K1
Deluxe, Chrome Plated Brass, Arm and Flange	\$121.00	1.6	M1
Low Flow Shower (1.5gpm), Arm & Flange	\$135.00	2.8	G1
Low Flow Shower (1.5gpm), Arm & Flange	\$106.00	0.53	H1
Arm & Flange Only (no showerhead)	\$27.00	0.3	O1
Economizer, Arm & Flange & Hi-Temp Shut-Off	\$124.00	1.1	J4
Standard Arm & Flange & Hi-Temp Shut-Off	\$157.00	1.5	K4
Deluxe Arm & Flange & Hi-Temp Shut-Off	\$192.00	1.9	M4
Low Flow Shower (1.6 gpm), Arm & Flange & Hi-Temp Shut-Off	\$207.00	3.1	G4
Low Flow Shower (1.5 gpm), Arm & Flange & Hi-Temp Shut-Off	\$178.00	1.1	H4
Tub Spouts			
Non-Diverter, Chrome Plated 1/2" IPS.	\$38.00	0.4	R
Diverter, Chrome Plated 1/2" IPS	\$53.00	0.7	S
Diverter, Chrome Plated 1/2" Slip-Fit.	\$46.00	1.0	U
Hand Shower Systems			
24" Chrome ADA Wall Grab Bar System	\$464.00	4.7	1
36" Chrome ADA Wall Grab Bar System	\$488.00	5.5	2
Deluxe, Metal Hose, 30" Glide Rail	\$524.00	3.5	3
Professional, Vinyl Hose, 30" Glide Rail	\$447.00	2.7	4
Standard, Metal Hose, Two Wall Hooks	\$185.00	2.0	5
Deluxe, Metal Hose, 24" Glide Rail	\$427.00	3.1	6
Professional, Vinyl Hose, 24" Glide Rail	\$244.00	2.3	7
Standard Plus, Metal Hose, 24" Glide Rail	\$278.00	3.0	8
European, Metal Hose, 23" Glide Rail	NLA	2.0	9
Low Flow (1.5gpm), Metal Hose, 30" Glide Rail	\$594.00	5.0	L
Professional, Metal Hose, 30" Glide Rail	\$410.00	2.8	N
Miscellaneous Accessories			
Vacuum Breaker, Elevated, Chrome-Plated	\$372.00	2.0	V
Vacuum Breaker, in-Line	\$36.00	1.0	W
Diverter, Concealed, 1/2" IPS Metal Handle	\$222.00	3.0	Y
Diverter, Concealed, Deluxe ABS Handle	\$163.00	3.0	A
Diverter, Concealed, Deluxe Metal Handle	\$177.00	3.0	B
Diverter, Exposed, Showerhead Type	\$46.00	0.5	Z

A WATTS Brand

All e700 Series valves feature advanced thermal actuators, adjustable handle rotation limit stop, integral checkstops, metal or ABS trim and 1/2" sweat connections. The e700 Series meets American with Disabilities Act (ADA) requirements.

5-year Limited Warranty.



e705

e707

e710

	List Price	Weight (lbs)	Order Code
Valves			
ABS Trim	\$352.00	3.5	e705
Metal Trim	\$370.00	3.5	e710
Euro Trim	\$403.00	3.5	e707
Showerheads			
Economizer, Chrome-Plated ABS, Adjustable.....	\$25.00	0.5	J
Standard, Chrome-Plated Brass.....	\$58.00	0.9	K
Deluxe, Chrome-Plated Brass.....	\$94.00	1.3	M
Low Flow (1.5 gpm), Chrome-Plated.....	\$108.00	2.5	G
Low Flow (1.5 gpm), Chrome-Plated.....	\$79.00	0.5	H
Arm and Flange Kits			
Standard Arm and Flange	\$27.00	0.3	1
Deluxe Arm and Flange	\$45.00	0.4	2
Standard Arm/Flange & Hi-Temp. Shut-Off	\$99.00	0.6	4
Deluxe Arm/Flange & Hi-Temp. Shut-Off	\$117.00	0.7	5
Tub Spouts			
Diverter, Chrome-Plated Brass, 3/4" IPS.....	\$111.00	1.2	Q
Non-Diverter, Chrome-Plated, 1/2" IPS	\$38.00	0.4	R
Diverter, Chrome-Plated, 1/2" IPS	\$53.00	0.7	S
Diverter, Chrome-Plated Brass, 1/2" IPS.....	\$119.00	1.3	T
Diverter, Chrome-Plated, 1/2" Slip-fit.....	\$46.00	1.0	U
Hand Shower Systems			
24" Chrome ADA Wall Grab Bar System.....	\$464.00	4.7	1
36" Chrome ADA Wall Grab Bar System.....	\$488.00	5.5	2
Deluxe, Metal Hose, 30" Glide Rail.....	\$524.00	3.5	3
Professional, Vinyl Hose, 30" Glide Rail.....	\$447.00	2.7	4
Standard, Metal Hose, Two Wall Hooks	\$185.00	2.0	5
Deluxe, Metal Hose, 24" Glide Rail.....	\$427.00	3.1	6
Professional, Vinyl Hose, 24" Glide Rail.....	\$244.00	2.3	7
Standard Plus, Metal Hose, 24" Glide Rail.....	\$278.00	3.0	8
European, Metal Hose, 23" Glide Rail.....	NLA	2.0	9
Low Flow (1.5 gpm), Metal Hose, 30" Glide Rail.....	\$594.00	2.8	L
Professional, Metal Hose, 30" Glide Rail	\$410.00	2.8	N
Diverter			
Concealed Diverting Valve, 1/2" IPS, Metal Handle.....	\$222.00	3.0	Y
Diverter, Concealed, Deluxe ABS Handle	\$163.00	3.0	A
Diverter, Concealed, Deluxe Metal Handle	\$177.00	3.0	B
Exposed Diverter, Shower Arm-Type, Chrome-Plated	\$46.00	0.5	Z
Vacuum Breakers			
Vacuum Breaker, Elevated, Chrome-Plated	\$372.00	2.0	V
Vacuum Breaker, In-Line	\$36.00	1.0	W

	Order Code	Weight	List Price
Biltmore™ Series 900 Accessories/Parts			
Vandal-Resistant Screw Kit*	900 034	0.11	NLA
<i>*Parts discount applies</i>			

Series PB410 HydroGuard® Pressure Balancing Valves

The series PB410 HydroGuard® features heavy, cast brass construction, a poppet type equalizing valve which offers a distinct advantage: it will not stick because of lime build-up or foreign particles in the supplies. The adjustable metal-to-metal temperature limit stop prevents accidental scalding caused by our adjustment of the handle. It also features integral checkstops, back to back and shallow installation. PB410 series is listed to ASSE 1016-P and certified to CSA B125 standard.



Model PB413000000

	Order Code	Weight	List Price
3 Port	PB413	4.0	\$672.00
4 Port	PB417	4.6	\$720.00

	Order Code	Weight	List Price
Series PB410 Accessories/Parts			
Stem Extension Accessory*	410 233	0.3	\$73.50

*Parts discount applies

To order complete Series PB410 systems...

Port	List Price	Weight (lbs)	Order Code
3 Port	\$672.00	4.0	PB413
4 Port	\$720.00	4.6	PB417
Showerheads			
Economizer, Chrome-Plated ABS, Adjustable	\$25.00	0.5	J
Standard, Chrome-Plated Brass	\$58.00	0.9	K
Deluxe, Chrome-Plated Brass	\$94.00	1.3	M
Low Flow (1.6 gpm) (Chrome-Plated)	\$108.00	2.5	G
Arm and Flange Kits			
Standard Arm and Flange	\$27.00	0.3	1
Deluxe Arm and Flange	\$45.00	0.4	2
Standard Arm/Flange & High Temp. Shut-Off	\$99.00	0.6	4
Deluxe Arm/Flange & High Temp. Shut-Off	\$117.00	0.7	5
Tub Spouts			
Diverter, Chrome-Plated Brass, 3/4" IPS	\$111.00	1.2	Q
Non-Diverter, Chrome-Plated, 1/2" IPS	\$38.00	0.4	R
Diverter, Chrome-Plated, 1/2" IPS	\$53.00	0.7	S
Diverter, Chrome-Plated Brass, 1/2" IPS	\$119.00	1.3	T
Diverter, Chrome-Plated, 1/2" Slip-fit	\$46.00	1.0	U
Hand Shower Systems			
24" Chrome ADA Wall Grab Bar System	\$464.00	4.7	1
36" Chrome ADA Wall Grab Bar System	\$488.00	5.5	2
Deluxe, Metal Hose, 30" Slide Bar	\$524.00	3.5	3
Professional, Vinyl Hose, 30" Glide Rail	\$447.00	2.7	4
Standard, Metal Hose, Two Wall Hooks	\$185.00	2.0	5
Deluxe, Metal Hose, 24" Glide Rail	\$427.00	3.1	6
Professional, Vinyl Hose, 24" Glide Rail	\$244.00	2.3	7
Standard Plus, Metal Hose, 24" Glide Rail	\$278.00	3.0	8
European, Metal Hose, 23" Glide Rail	NLA	2.0	9
Low Flow (1.5 gpm), Metal Hose, 30" Glide Rail	\$594.00	5.0	L
Professional, Metal Hose, 30" Glide Rail	\$510.00	2.8	N
Diverters			
Concealed Diverting Valve, 1/2" IPS, Metal Handle	\$222.00	3.0	Y
Diverter, Concealed, Deluxe ABS Handle	\$163.00	3.0	A
Diverter, Concealed, Deluxe Metal Handle	\$177.00	3.0	B
Exposed Diverter, Shower Arm-Type, Chrome-Plated	\$46.00	0.5	Z
Vacuum Breakers			
Vacuum Breaker, Elevated, Chrome-Plated	\$372.00	2.0	V
Vacuum Breaker, in-Line	\$36.00	1.0	W

A **WATTS** Brand

VisuGuard LCD features advanced thermal actuator, battery operated LCD temperature readout. Battery enclosure is easily accessible and watertight. ASSE 1016 T/P and cUPC listed.



	List Price	Weight (lbs)	Order Code	□	7	2	7	□	□	□	□	□	□
Temperature Display (factory set)													
Celsius	\$ 852.00	4.8	C										
Fahrenheit	NLA	4.8	F										
Showerheads													
Economizer, Chrome-Plated ABS, Adjustable	\$ 25.00	0.5	J										
Standard, Chrome-Plated Brass	\$ 58.00	0.9	K										
Deluxe, Chrome-Plated Brass	\$ 94.00	1.3	M										
Low Flow (1.6 gpm), Chrome-Plated	\$ 108.00	2.5	G										
Low Flow (1.5 gpm), Chrome-Plated	\$ 79.00	0.5	H										
Arm & Flange Kits													
Standard Arm & Flange	\$ 27.00	0.3	1										
Deluxe Arm & Flange	\$ 45.00	0.4	2										
Standard Arm/Flange & High Temp. Shut-Off	\$ 99.00	0.6	4										
Deluxe Arm/Flange & High Temp. Shut-Off	\$ 117.00	0.7	5										
Tub Spout													
Diverter, Chrome-Plated Brass, 3/4" IPS.	\$ 111.00	1.2	Q										
Non-Diverter, Chrome-Plated, 1/2" IPS	\$ 38.00	0.4	R										
Diverter, Chrome-Plated Brass, 1/2" IPS.	\$ 53.00	0.7	S										
Diverter, Chrome-Plated Brass, 1/2" IPS.	\$ 119.00	1.3	T										
Diverter, Chrome-Plated, 1/2" Slip-fit	\$ 46.00	1.0	U										
Hand Shower System													
24" Chrome ADA Wall Grab Bar System	\$ 464.00	4.7	1										
36" Chrome ADA Wall Grab Bar System	\$ 488.00	5.5	2										
Deluxe, Metal Hose, 30" Glide Rail	\$ 524.00	3.5	3										
Professional, Vinyl Hose, 30" Glide Rail	\$ 447.00	2.7	4										
Standard, Metal Hose, 2 Wall Hooks	\$ 185.00	2.0	5										
Standard, Metal Hose, 24" Glide Rail	\$ 427.00	3.1	6										
Professional, Vinyl Hose, 24" Glide Rail	\$ 244.00	2.3	7										
Standard Plus, Metal Hose, 24" Glide Rail	\$ 278.00	3.0	8										
European, Metal Hose, 23" Glide Rail	NLA	2.0	9										
Low Flow (1.5 gpm), Metal Hose, 30" Glide Rail	\$ 594.00	5.0	L										
Professional, Metal Hose, 30" Glide Rail	\$ 510.00	2.8	N										
Diverter													
Diverter, Concealed, 1/2" IPS, Metal Handle	\$ 222.00	3.0	Y										
Diverter, Concealed, 1/2" IPS, Deluxe ABS Handle	\$ 163.00	3.0	A										
Diverter, Concealed, 1/2" IPS, Deluxe Metal Handle	\$ 177.00	3.0	B										
Exposed Diverter, Shower Arm-Type	\$ 46.00	0.5	Z										
Vacuum Breakers													
Vacuum Breaker, Elevated, Chrome-Plated	\$ 372.00	2.0	V										
Vacuum Breaker, In-Line	\$ 36.00	1.0	W										

POWERS™ HydroGuard® T/P Series e420 Combination Valves

A WATTS Brand

HydroGuard T/P® Series e420 Valves

All HydroGuard T/P® shower valves feature advanced thermal actuator compensate for both temperature and pressure fluctuations. A built-in adjustable metal-to-metal temperature limit stop reduces chance of accidental scalding due to the over adjustment of handle. Heavy cast brass body, integral checkstop, durable brass faceplate, lever-type handles, and corrosion-resistant material provide years of trouble-free service. ASSE 1016 T/P listed and CSA B125 certified.



4 Ports concealed valves, 1/2" NPT inlets/outlets

	Order Code	Weight	List Price
Color coded trim plate, Dome handle	e420T12	5.5	\$837.00
Etched trim plate, Dome handle	e420T22	5.5	\$837.00

4 Ports concealed valves, 1/2" Sweat inlets/outlets

	Order Code	Weight	List Price
Color coded trim plate, Dome handle.	e420S12	5.5	\$837.00
Etched trim plate, Dome handle	e420S22	5.5	\$837.00

Series e423 Thermostatic Valve

HydroGuard Series e423 Valves

Exposed thermostatic water mixing valve features advance thermal actuator, adjustable limit stop, polished chrome-plated lever handle and mounting bracket. ASSE 1016, CSA



Model e423320



Valve	List Price	Weight	Order Code
e42332	\$996.00	5.3	e423
Checkstops (Sold in Pairs)			
Straight, 1/2" IPS, Polished Chrome	NLA	1.0	B
Angled with Strainer, 1/2" IPS, Polished Chrome.	\$444.00	2.4	F
Factory installation of checkstops (add suffix "X" to checkstop code) Min. order 10 . . .	\$50.00	---	X

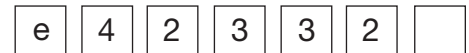

A WATTS Brand

Order	List Price	Weight (lbs)	Code	e420
Connections				
1/2" NPT Inlets/Outlets	\$ 837.00	5.0	T	□
1/2" Sweat Inlets/Outlets	\$ 837.00	5.0	S	□
Trim Plate				
Color Coded	N/C	—	1	□
Etched	N/C	—	2	□
Handle				
Dome	N/C	—	2	□
Showerheads				
Economizer, Chrome-Plated ABS, Adjustable	\$ 25.00	0.5	J	□
Standard, Chrome-Plated Brass	\$ 58.00	0.9	K	□
Deluxe, Chrome-Plated Brass	\$ 94.00	1.3	M	□
Low Flow (1.5 gpm), Chrome-Plated	\$ 108.00	2.5	G	□
Low Flow (1.5 gpm), Chrome-Plated	\$ 79.00	0.5	H	□
Arm & Flange Kits				
Standard Arm & Flange	\$ 27.00	0.3	1	□
Deluxe Arm & Flange	\$ 45.00	0.4	2	□
Standard Arm/Flange & High Temp. Shut-Off	\$ 99.00	0.6	4	□
Deluxe Arm/Flange & High Temp. Shut-Off	\$ 117.00	0.7	5	□
Tub Spouts				
Diverter, Chrome-Plated Brass, 3/4" IPS	\$ 111.00	1.2	Q	□
Non-Diverter, Chrome-Plated, 1/2" IPS	\$ 38.00	0.4	R	□
Diverter, Chrome-Plated, 1/2" IPS	\$ 53.00	0.7	S	□
Diverter, Chrome-Plated Brass, 1/2" IPS	\$ 119.00	1.3	T	□
Diverter, Chrome-Plated, 1/2" Slip-fit	\$ 46.00	1.0	U	□
Hand Shower Systems				
24" Chrome ADA Wall Grab Bar System	\$ 464.00	4.7	1	□
36" Chrome ADA Wall Grab Bar System	\$ 488.00	5.5	2	□
Deluxe, Metal Hose, 30" Glide Rail	\$ 524.00	3.5	3	□
Professional, Vinyl Hose, 30" Glide Rail	\$ 447.00	2.7	4	□
Standard, Metal Hose, Two Wall Hooks	\$ 185.00	2.0	5	□
Deluxe, Metal Hose, 24" Glide Rail	\$ 427.00	3.1	6	□
Professional, Vinyl Hose, 24" Glide Rail	\$ 244.00	2.3	7	□
Standard Plus, Metal Hose, 24" Glide Rail	\$ 278.00	3.0	8	□
European, Metal Hose, 23" Glide Rail	NLA	2.0	9	□
Low Flow (1.6 gpm), Metal Hose, 30" Glide Rail	\$ 594.00	5.0	L	□
Professional, Metal Hose, 30" Glide Rail	\$ 510.00	2.8	N	□
Diverter				
Concealed Diverting Valve, 1/2" IPS, Metal Handle	\$ 222.00	3.0	Y	□
Diverter, Concealed, Deluxe ABS Handle	\$ 163.00	3.0	A	□
Diverter, Concealed, Deluxe Metal Handle	\$ 177.00	3.0	B	□
Exposed Diverter, Shower Arm-Type, Chrome-Plated	\$ 46.00	0.5	Z	□
Vacuum Breakers				
Vacuum Breaker, Elevated, Chrome-Plated	\$ 372.00	2.0	V	□
Vacuum Breaker, In-Line	\$ 36.00	1.0	W	□

A WATTS Brand

e427/e428 HydroGuard® Shower valves features advanced thermal actuator, adjustable handle rotation limit stop, stainless steel dial plate with concealed mounting screws, and color coded temperature graphics. ASSE 1016 listed CSA certified.



Model e427

Model e428

Valves	List Price	Weight (lbs)	Order Code
Concealed	\$1,180.00	5.8	e427*
Exposed Chrome-Plated	\$1,365.00	5.7	e428*
Checkstops (Sold in Pairs)			
Concealed			
Straight, 1/2" IPS	\$84.00	1.1	A
Straight, 1/2" Sweat	\$84.00	1.1	C
Angled, 1/2" Sweat	\$201.00	1.3	D
Angled, with Strainer, 1/2" IPS	\$286.00	2.5	E
Exposed			
Straight, 1/2" IPS, Chrome-Plated	NLA	1.0	B
Angled, with Strainer, 1/2" IPS, Chrome-Plated	\$444.00	2.4	F
Showerheads			
Economizer, Chrome-Plated ABS, Adjustable	\$25.00	0.5	J
Standard, Chrome-Plated Brass	\$58.00	0.9	K
Deluxe, Chrome-Plated Brass	\$94.00	1.3	M
Low Flow (1.5 gpm), Chrome-Plated	\$108.00	2.5	G
Low Flow (1.5 gpm), Chrome-Plated	\$79.00	0.5	H
Arm and Flange Kits			
Standard Arm and Flange	\$27.00	0.3	1
Deluxe Arm and Flange	\$45.00	0.4	2
Standard Arm/Flange & High Temp. Shut-Off	\$99.00	0.6	4
Deluxe Arm/Flange & High Temp. Shut-Off	\$117.00	0.7	5
Tub Spouts			
Diverter, Chrome-Plated Brass, 3/4" IPS	\$111.00	1.2	Q
Non-Diverter, Chrome-Plated, 1/2" IPS	\$38.00	0.4	R
Diverter, Chrome-Plated, 1/2" IPS	\$53.00	0.7	S
Diverter, Chrome-Plated Brass, 1/2" IPS	\$119.00	1.3	T
Diverter, Chrome-Plated, 1/2" Slip-fit	\$46.00	1.0	U
Hand Shower Systems			
24" Chrome ADA Wall Grab Bar System	\$464.00	4.7	1
36" Chrome ADA Wall Grab Bar System	\$488.00	5.5	2
Deluxe, Metal Hose, 30" Glide Rail	\$524.00	3.5	3
Professional, Vinyl Hose, 30" Glide Rail	\$447.00	2.7	4
Standard, Metal Hose, Two Wall Hooks	\$185.00	2.0	5
Deluxe, Metal Hose, 24" Glide Rail	\$427.00	3.1	6
Professional, Vinyl Hose, 24" Glide Rail	\$244.00	2.3	7
Standard Plus, Metal Hose, 24" Glide Rail	\$278.00	3.0	8
European, Metal Hose, 23" Glide Rail	NLA	2.0	9
Low Flow (1.5 gpm), Metal Hose, 32" Glide Rail	\$594.00	5.0	L
Professional, Metal Hose, 30" Glide Rail	\$510.00	2.8	N
Diverter			
Concealed Diverting Valve, 1/2" IPS, Metal Handle	\$222.00	3.0	Y
Diverter, Concealed, Deluxe ABS Handle	\$163.00	3.0	A
Diverter, Concealed, Deluxe Metal Handle	\$177.00	3.0	B
Exposed Diverter, Shower Arm-Type, Chrome-Plated	\$46.00	0.5	Z
Vacuum Breakers			
Vacuum Breaker, Elevated, Chrome-Plated	\$372.00	2.0	V
Vacuum Breaker, In-Line	\$36.00	1.0	W

*For Shower or Bath only application. Not suitable for Combination Bath & Shower application

A **WATTS** Brand

TempTAP™ thermostatic faucets feature solid brass construction and an advanced thermal actuator to provide the latest in thermal protection. TempTAP™ faucets automatically mix hot and cold water and deliver pre-set water within a specific range. TempTAP™ thermostatic faucets are listed to ASSE 1070, IAPMO cJPC and certified to NSF/ANSI 61 Section 9 Annex G. They also meet the activation requirements of ADA.



Description	List Price	Weight (lbs)	Order Code
Lavatory Faucet & 2.0 gpm Aerator	\$467.00	3.5	105
Lavatory Faucet & 2.0 gpm Vandal Resistant Aerator	\$490.00	3.5	105VA
Lavatory Faucet, 6" Lever Handle & 2.0 Aerator	\$491.00	3.7	105-6
Lavatory Faucet, 2.0 gpm Aerator & Pop-Up Waste	\$521.00	3.8	105PW
Lavatory Faucet & 0.5 gpm Outlet	\$495.00	3.5	105A5
Lavatory Faucet & 0.5 gpm Vandal Resistant Outlet	\$492.00	3.5	105V5
Lavatory Faucet & 1.5 gpm Aerator+	\$495.00	3.5	105A15
Lavatory Faucet & 2.0 gpm Laminar flow outlet	\$490.00	3.5	105L
Lavatory Faucet & 2.0 gpm Vandal Resistant Laminar flow outlet	\$492.00	3.5	105VL
Lavatory Faucet & 0.5 gpm Laminar flow outlet	\$510.00	3.5	105L5
Lavatory Faucet & 0.5 gpm Vandal Resistant Laminar flow outlet	\$521.00	3.5	105VL5
Lavatory Faucet, Deck Plate & 2.0 gpm Aerator	\$516.00	4.1	115
Lavatory Faucet, Deck Plate & 2.0 gpm Vandal Resistant Aerator	\$495.00	4.1	115VA
Lavatory Faucet, Deck Plate, 6" Lever Handle & 2.0 Aerator	\$529.00	4.3	115-6
Lavatory Faucet, Deck Plate, 2.0 gpm Aerator & Pop-Up Waste	\$549.00	4.4	115PW
Lavatory Faucet, Deck Plate & 0.5 gpm Outlet	\$498.00	4.1	115A5
Lavatory Faucet, Deck Plate & 0.5 gpm Vandal Resistant Outlet	\$522.00	4.1	115V5
Lavatory Faucet, Deck Plate & 1.5 gpm Aerator+	\$522.00	4.1	115A15
Lavatory Faucet, Deck Plate & 2.0 gpm Laminar flow outlet	\$538.00	4.1	115L
Lavatory Faucet, Deck Plate & 2.0 gpm Vandal Resistant Laminar flow outlet	\$502.00	4.1	115VL
Lavatory Faucet, Deck Plate & 0.5 gpm Laminar flow outlet	\$558.00	4.1	115L5
Lavatory Faucet, Deck Plate & 0.5 gpm Vandal Resistant Laminar flow outlet	\$571.00	4.1	115VL5
Gooseneck Spout & 2.0 gpm Aerator	\$596.00	4.7	205
Gooseneck Spout & 2.0 gpm Vandal Resistant Aerator	\$621.00	4.7	205VA
Gooseneck Spout, 6" Lever Handle & 2.0 Aerator	\$622.00	4.9	205-6
Gooseneck Spout & 0.5 gpm Outlet	\$607.00	4.7	205A5
Gooseneck Spout & 0.5 gpm Vandal Resistant Outlet	\$679.00	4.7	205V5
Gooseneck Spout & 1.5 gpm Aerator+	\$556.00	4.7	205A15
Gooseneck Spout & 2.0 gpm Laminar flow outlet	\$621.00	4.7	205L
Gooseneck Spout & 2.0 gpm Vandal Resistant Laminar flow outlet	\$623.00	4.7	205VL
Gooseneck Spout & 0.5 gpm Laminar flow outlet	\$640.00	4.7	205L5
Gooseneck Spout & 0.5 gpm Vandal Resistant Laminar flow outlet	\$611.00	4.7	205VL5
Gooseneck Spout, Deck Plate & 2.0 gpm Aerator	\$636.00	5.1	215
Gooseneck Spout, Deck Plate & 2.0 gpm Vandal Resistant Aerator	\$660.00	5.1	215VA
Gooseneck Spout, Deck Plate, 6" Lever Handle & 2.0 Aerator	\$661.00	5.3	0215-6
Gooseneck Spout, Deck Plate & 0.5 gpm Outlet	\$642.00	5.1	215A5
Gooseneck Spout, Deck Plate & 0.5 gpm Vandal Resistant Outlet	\$663.00	5.1	215V5
Gooseneck Spout, Deck Plate & 1.5 gpm Aerator+	\$575.00	5.1	215A15
Gooseneck Spout, Deck Plate & 2.0 gpm Laminar flow outlet	\$705.00	5.1	215L
Gooseneck Spout, Deck Plate & 2.0 gpm Vandal Resistant Laminar flow outlet	\$672.00	5.1	215VL
Gooseneck Spout, Deck Plate & 0.5 gpm Laminar flow outlet	\$679.00	5.1	215L5
Gooseneck Spout, Deck Plate & 0.5 gpm Vandal Resistant Laminar flow outlet	\$692.00	5.1	215VL5

+WaterSense applies to 1.5 gpm models only.

A WATTS Brand

LEAD FREE*

HydroGuard® Series LFe480 Lavatory

Thermostatic Tempering Valves

Under the counter thermostatic mixer for lavatory applications. ASSE 1070 listed and cUPC. Integral checks. Solid brass construction. Adjustable temperature with locking feature.

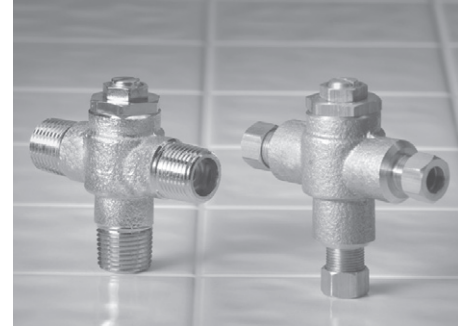

Description	Order Code	Weight	List Price
1/2" NPT inlets and outlet, Minimum Flow 0.25gpm	LFG480-00	1.00	\$264.00
1/2" NPT inlets and outlet, Minimum Flow 0.25gpm, Chrome Plated	LFG480-01	1.00	\$271.00
3/8" Compression inlets & outlet, Minimum Flow 0.25gpm	LFG480-10	1.00	\$264.00
3/8" Compression inlets & outlet, Minimum Flow 0.25gpm, Chrome Plated	LFG480-11	1.00	\$271.00
3/8" Quick Connect, Minimum Flow 0.25gpm	LFG480-50	1.10	\$341.00
3/8" Quick Connect, Minimum Flow 0.25gpm, Chrome plated	LFG480-51	1.10	\$350.00
1/2" NPT inlets and outlet, Minimum Flow 0.5gpm	LFe480-00	1.00	\$264.00
1/2" NPT inlets & outlet, Chrome Plated, Minimum Flow 0.5gpm	LFe480-01	1.00	\$271.00
3/8" Compression inlets & outlet, Minimum Flow 0.5gpm	LFe480-10	1.00	\$264.00
3/8" Compression inlets & outlet, Chrome Plated, Minimum Flow 0.5gpm	LFe480-11	1.00	\$271.00
3/8" Quick Connect, Minimum Flow 0.5gpm	LFe480-50	1.08	\$341.00
3/8" Quick Connect, Chrome Plated, Minimum Flow 0.5gpm	LFe480-51	1.06	\$350.00

LEAD FREE*

HydroGuard® Series LFLM490

HydroGuard® Series LFLM490 Thermostatic Tempering Valves for Hot Water Heaters and Multiple Lavatory Installations

All HydroGuard Series LFLM490 Valves feature advanced thermal actuator, adjustable lock-in handle design, solid brass construction and integral check valves and screens. CSA certified, ASSE 1017, and IAPMO listed.

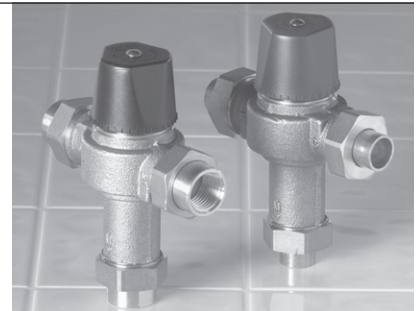

Temperature Range 90° - 160°F (32° - 71°C) Model LFLM49

Temperature Range 60° - 120°F (16° - 49°C) Model LFLM49 -10

Valve	List Price	Weight	Order Code
1/2"	\$ 273.00	1.8	0
3/4"	\$ 273.00	2.3	1
1"	\$ 302.00	2.9	2
302 Inlets/Outlets			
Union NPT Female	N/C	—	1
Union Sweat	N/C	—	2
Union CPVC	N/C	—	3
Union PEX	N/C	—	4
Quick-Connect			
1/2"	\$ 52.00	—	5
3/4"	\$ 77.00	—	5
1"	\$ 83.00	—	5
With Press			
1/2"	\$ 66.00	—	1-w/Press
3/4"	\$ 77.00	—	1-w/Press
1"	\$ 118.00	—	1-w/Press

*The wetted surface of this product contacted by consumable water contains less than 0.25% of lead by weight.

A WATTS Brand

LEAD FREE*

HydroGuard® Series LFLM495 Thermostatic Tempering Valves for Individual Lavatory Installations

All HydroGuard Series LFLM495 valves feature advanced thermal actuator, adjustable lock-in handle design, solid brass construction and integral check valves and screens. CSA certified, ASSE 1069, ASSE 1070 and IAPMO listed.

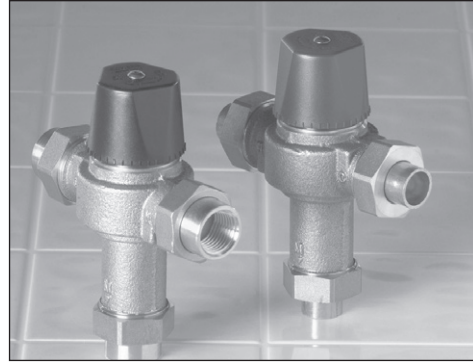

**Temperature Range 80° - 120° F
(27° - 49° C)**

Model LFLM49 -

Valve	List Price	Weight	Order Code
1/2"	\$ 273.00	1.8	5
3/4"	\$ 273.00	2.3	6
1"	\$ 302.00	2.9	7
Inlets/Outlets			
Union NPT Female	N/C	—	1
Union Sweat	N/C	—	2
Union CPVC	N/C	—	3
Union PEX	N/C	—	4
Quick-Connect		—	5
1/2"	\$ 52.00	—	5
3/4"	\$ 77.00	—	5
1"	\$ 83.00	—	5
With Press			
1/2"	\$ 66.00	—	1-w/Press
3/4"	\$ 77.00	—	1-w/Press
1"	\$ 118.00	—	1-w/Press

Hot Water Tank Capacity Extender

The hot water tank capacity extender increases hot water capacity as much as 133% depending on storage and cold water temperature flow.

	List Price	Weight	Ordering Code
3/4" Inlets & Outlet	\$ 399.00	3.0	LFLM496-HTK



*The wetted surface of this product contacted by consumable water contains less than 0.25% of lead by weight.

LEAD FREE*

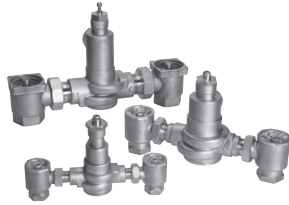

The HydroGuard® XP series LFMM430 is a temperature actuated mixing valve designed for use in hot water distribution system, in compliance with ASSE 1017 standard. Valve features advance paraffin actuation technology, dirt and lime resistant poppet and seat design and vandal resistant locking mechanism. Valve are available in two temperature ranges.

Valve	Rough Bronze		Chrome Plated	
	Standard (90-160°F)	Low (60-90°F)	Standard (90-160°F)	Low (60-90°F)
LFMM431 3/4 x 3/4	LFMM431-10 \$1,313.00	LFMM431-30 \$1,313.00	LFMM431-20 \$1,700.00	LFMM431-40 \$1,700.00
LFMM432 3/4 x 1	LFMM432-10 \$1,420.00	LFMM432-30 \$1,420.00	LFMM432-20 \$1,853.00	LFMM432-40 \$1,853.00
LFMM433 1 1/4 x 1 1/4	LFMM433-10 \$1,945.00	LFMM433-30 \$1,945.00	LFMM433-20 \$2,415.00	LFMM433-40 \$2,415.00
LFMM434 1 1/4 x 1 1/2	LFMM434-10 \$2,450.00	LFMM434-30 \$2,450.00	LFMM434-20 \$2,765.00	LFMM434-40 \$2,765.00
LFMM435 2 x 2	LFMM435-10 \$3,412.00	LFMM435-30 \$3,412.00	LFMM435-20 \$3,793.00	LFMM435-40 \$3,793.00

HydroGuard® XP Series LFMM430 Supply Fixtures

How to specify and order a supply fixture:

Valves (capacity at 45 psi)

23 gpm (87 lpm)	LM490
42 gpm (159 lpm)	MM431
64 gpm (242 lpm)	MM432
110 gpm (416 lpm)	MM433
144 gpm (545 lpm)	MM434
208 gpm (787 lpm)	MM435

Valve and Pipe Finish

Rough Bronze	A
Chrome Plated	C

Piping Inlets/Outlets

Top/Top	D
Bottom/Top	E
Bottom/Bottom	F
Bottom/Side	G

Cabinet Style

Exposed, no cabinet	M
Stainless Steel, Recessed	N
Stainless Steel, Semi-Recessed	P
Stainless Steel, Wall Mounted	Q
Painted, Recessed	R
Painted, Semi-Recessed	T
Painted, Wall Mounted	U

Temperature Range

Standard—90°F to 160°F (32°C to 71°C)	S
Low**—60°F to 90°F (16°C to 32°C)	W

Options

None	0
Cold Water Bypass	2
Combination T/P Gauge on inlets	4
Cold Water Bypass & Combination T/P Gauge on inlets	6

Alarm System (Not Installed)

None	0
AquaSentry2 Alarm System	4

View Port

None	0
Window	W

** Not available with LFLM490.

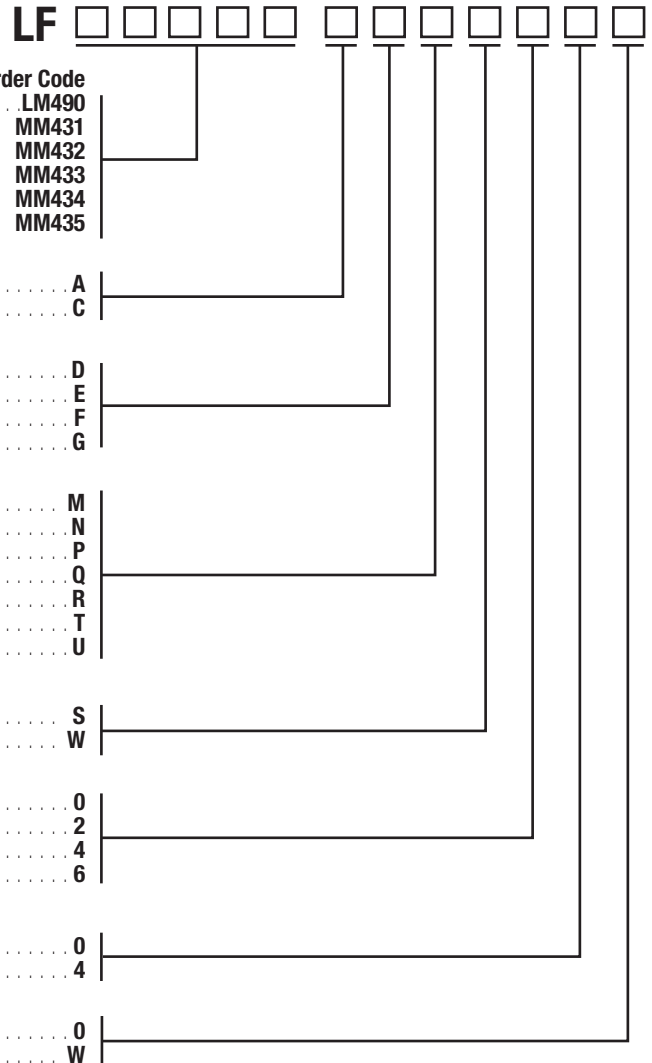

Note: Supply fixtures are made to order (MTO) and are not returnable or subject to credit.

*The wetted surface of this product contacted by consumable water contains less than 0.25% of lead by weight.

A WATTS Brand

LEAD FREE*

HydroGuard® XP Series LFMM430 Supply Fixtures

How to Determine the Price of a Supply Fixture

Determine the base price by looking in the first two columns of this chart, under "Valve and Pipe Finish." This price includes the valve and standard piping kit, dial thermometer, and a standard temperature range motor. If a cabinet, a high or low temperature motor or an optional piping kit is required, add the list price shown below to the base price.

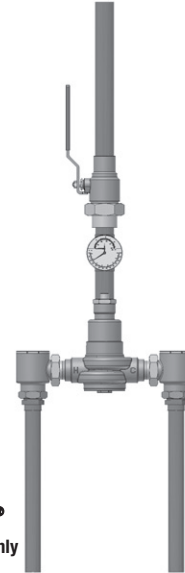

Valve only

Model LFMM432AEMS00

Order Code	Valve and Pipe Finish		Cabinet Style	
	Rough Bronze	Chrome Plated	Stainless Steel	Painted
	A	C	N, P, Q	R, T, U
LFLM490	1,355.00	1,538.00	1,677.00	1,118.00
LFMM431	2,029.00	2,305.00	2,082.00	1,229.00
LFMM432	2,340.00	2,680.00	2,082.00	1,229.00
LFMM433	2,846.00	3,323.00	2,082.00	1,229.00
LFMM434	3,446.00	4,010.00	2,082.00	1,229.00
LFMM435	3,960.00	5,751.00	2,488.00	1,628.00

Order Code	Options						Standard Items
		Cold Water Bypass	Combination T/P Gauge on Inlets	Cold Water Bypass & Comb. T/P Gauge on Inlets	AquaSentry2	View Port	Available at No Charge
	W	2	4	6	4	W	D, E, F, G, M, S
LFLM490	N/A	711.00	261.00	970.00	2,258.00	225.00	N/C
LFMM431	N/C	1,003.00	320.00	1,239.00	2,320.00	225.00	N/C
LFMM432	N/C	1,069.00	320.00	1,384.00	2,487.00	225.00	N/C
LFMM433	N/C	1,069.00	406.00	1,585.00	2,905.00	225.00	N/C
LFMM434	N/C	1,354.00	406.00	1,739.00	3,198.00	225.00	N/C
LFMM435	N/C	1,678.00	507.00	2,171.00	4,518.00	225.00	N/C

Note: Supply fixtures are made to order (MTO) and are not returnable or subject to credit.

*The wetted surface of this product contacted by consumable water contains less than 0.25% of lead by weight.

A WATTS Brand

LEAD FREE*

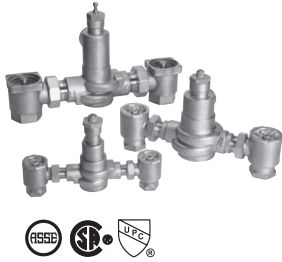

The HydroGuard® XP series LFSH1430 is a temperature actuated mixing valve designed for use in hot water distribution system, in compliance with ASSE 1017 standard. Valve features advanced paraffin actuation technology, dirt and lime resistant poppet and seat design and vandal resistant locking mechanism. Valve is available in two temperature ranges.

Valve	Valve Only			
	Rough Bronze		Chrome Plated	
	Standard (90-160°F)	Low (60-90°F)	Standard (90-160°F)	Low (60-90°F)
LFSH1432 3/4 x 1	LFSH1432-10 \$3,452.00	LFSH1432-30 \$3,452.00	LFSH1432-20 \$3,607.00	LFSH1432-40 \$3,607.00
LFSH1434 1 1/4 x 1 1/2	LFSH1434-10 \$4,711.00	LFSH1434-30 \$4,711.00	LFSH1434-20 \$5,454.00	LFSH1434-40 \$5,454.00
LFSH1435 2 x 2	LFSH1435-10 \$5,921.00	LFSH1435-30 \$5,921.00	LFSH1435-20 \$6,226.00	LFSH1435-40 \$6,226.00

Valve	Valve w/Temperature/Pressure Gauge on Outlet			
	Rough Bronze		Chrome Plated	
	Standard (90-160°F)	Low (60-90°F)	Standard (90-160°F)	Low (60-90°F)
LFSH1432 3/4 x 1	LFSH1432-11 \$3,230.00	LFSH1432-31 \$3,230.00	LFSH1432-22 \$3,874.00	LFSH1432-42 \$3,874.00
LFSH1434 1 1/4 x 1 1/2	LFSH1434-13 \$4,662.00	LFSH1434-33 \$4,662.00	LFSH1434-24 \$5,454.00	LFSH1434-44 \$5,454.00
LFSH1435 2 x 2	LFSH1435-15 \$6,200.00	LFSH1435-35 \$6,200.00	LFSH1435-26 \$6,471.00	LFSH1435-46 \$6,471.00

HydroGuard® XP Series LFSH1430 Supply Fixtures

How to specify and order a supply fixture:



	SH1432	SH1434	SH1435	Order Code
Valve and Piping Finish				
Rough Bronze	\$ 3,667.00	\$ 5,253.00	\$ 6,766.00	A
Chrome Plated	\$ 4,172.00	\$ 5,874.00	\$ 7,703.00	C
Piping Inlets/Outlet				
Top/Top	N/C	N/C	N/C	D
Bottom/Top	N/C	N/C	N/C	E
Bottom/Bottom	N/C	N/C	N/C	F
Bottom/Side	N/C	N/C	N/C	G
Cabinet Style				
Exposed, no cabinet	N/C	N/C	N/C	M
Stainless Steel, Recessed	\$ 2,079.00	\$ 2,079.00	\$ 2,488.00	N
Stainless Steel, Semi-Recessed	\$ 2,079.00	\$ 2,079.00	\$ 2,488.00	P
Stainless Steel, Wall Mounted	\$ 2,079.00	\$ 2,079.00	\$ 2,488.00	Q
Painted, Recessed	\$ 1,228.00	\$ 1,228.00	\$ 1,628.00	R
Painted, Semi-Recessed	\$ 1,228.00	\$ 1,228.00	\$ 1,628.00	T
Painted, Wall Mounted	\$ 1,228.00	\$ 1,228.00	\$ 1,628.00	U
Temperature Range				
Standard—90°F to 160°F (32°F to 71°C)	N/C	N/C	N/C	S
Low—60°F to 90°F (16°F to 32°C)	N/C	N/C	N/C	W
Option				
None	N/C	N/C	N/C	0
Cold Water Bypass	\$ 1,237.00	\$ 1,572.00	\$ 1,960.00	2
Combination T/P Gauge on Inlets	\$ 372.00	\$ 449.00	\$ 558.00	4
Cold Water Bypass & Combination T/P Gauge on Inlets	\$ 1,607.00	\$ 2,012.00	\$ 2,602.00	6
Alarm System (Not Installed)				
None	N/C	N/C	N/C	0
AquaSentry2 Alarm System	\$ 3,236.00	\$ 4,005.00	\$ 4,963.00	4
View Port				
None	N/C	N/C	N/C	0
Window	\$ 225.00	\$ 225.00	\$ 225.00	W

Note: Supply fixtures are made to order (MTO) and are not returnable or subject to credit.

*The wetted surface of this product contacted by consumable water contains less than 0.25% of lead by weight.

LEAD FREE*

The Lead Free HydroGuard® water tempering recirculating loop is an economical way to provide a safe, balanced system for stand alone master tempering valves. The system monitors return line temperature and automatically directs water to the cold side of the tempering valve (if within the set point) or to the hot water source (if below the set point).

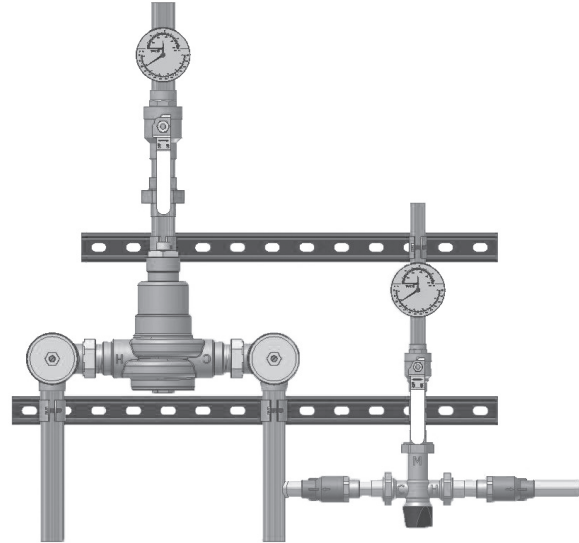

Valve Capacity @ 45 gpm	List Price
42 gpm (159 lpm)	\$ 3,685.00
64 gpm (242 lpm)	\$ 3,785.00
110 gpm (416 lpm)	\$ 4,354.00
144 gpm (545 lpm)	\$ 5,015.00
208 gpm (787 lpm)	\$ 6,113.00
57 gpm (216 lpm)	\$ 5,011.00
127 gpm (481 lpm)	\$ 5,675.00
201 gpm (761 lpm)	\$ 6,981.00

Valve & Piping Finish	
Rough Bronze	N/C

Return Size	
3/4"	N/C
1"	\$ 248.00

Temperature Range	
Standard (90° - 160°F)	N/C
Low (60° - 90°F)	N/C

Alarm System (not installed)	
None	N/C
AquaSentry2 for LFM431	\$ 3,744.00
AquaSentry2 for LFM432	\$ 3,854.00
AquaSentry2 for LFM433	\$ 3,929.00
AquaSentry2 for LFM434	\$ 4,244.00
AquaSentry2 for LFM435	\$ 4,963.00
AquaSentry2 for LFSH1432	\$ 3,263.00
AquaSentry2 for LFSH1434	\$ 4,005.00
AquaSentry2 for LFSH1435	\$ 4,963.00

LF R A

Order Code
MM431
MM432
MM433
MM434
MM435
SH1432
SH1434
SH1435

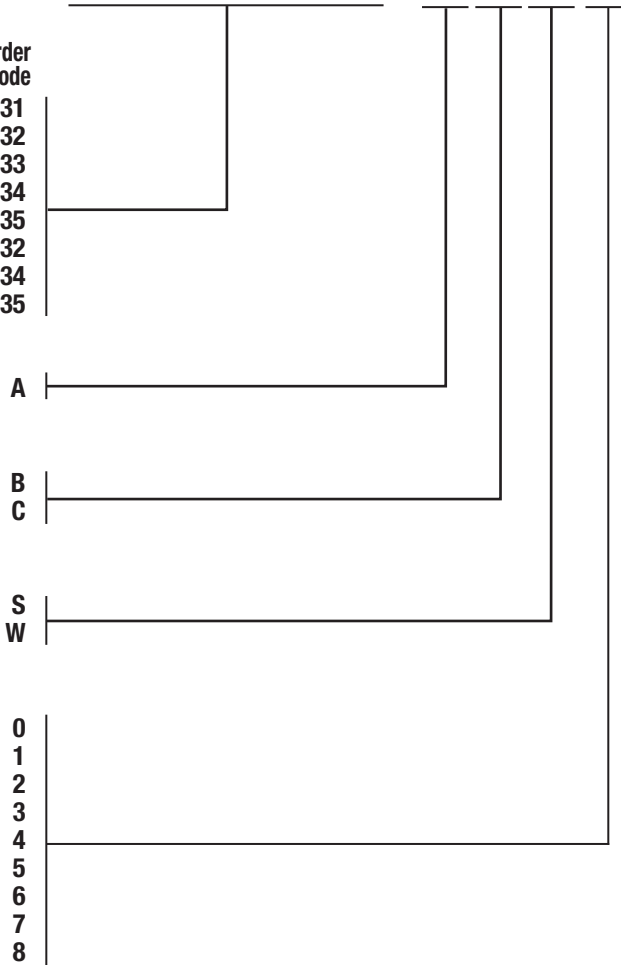

*The wetted surface of this product contacted by consumable water contains less than 0.25% of lead by weight.

Note: These products are specially made and are not returnable or subject to credit.

LEAD FREE*

Hi/Lo Supply Fixtures

Hi/Lo Supply Fixtures include two master mixing valves, a pressure regulating valve, outlet thermometer, shutoff valve, and pressure gauges. Piping configuration is bottom inlets/top outlet. For other configurations, consult Powers Technical Support Department.



LFMM432HLAEM00

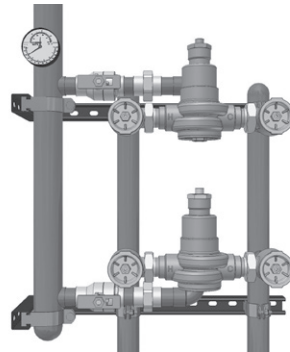

LFSH1434DVAEM00

LF

Valve Configuration	Capacity	Inlets	Outlet	List Price	Order Code
LFLM490/LFMM431	0.5 - 65 gpm	3/4"	3/4"	\$6,338.00	MM431HL
LFLM490/LFMM432	0.5 - 87 gpm	3/4"	1"	\$5,746.00	MM432HL
LFLM490/LFMM433	0.5 - 133 gpm	1-1/4"	1-1/4"	\$7,490.00	MM433HL
LFLM490/LFMM434	0.5 - 167 gpm	1-1/4"	1-1/2"	\$8,088.00	MM434HL
LFMM431/LFMM434	3.0 - 186 gpm	1-1/4"	1-1/2"	\$9,799.00	MM435HL
Larger Size					
LFMM434/LFSH1432	1.0 - 201 gpm	1-1/2"	2"	\$10,115.00	SH1432HL
LFMM434/LFSH1434	1.0 - 271 gpm	2"	2-1/2"	\$10,714.00	SH1434HL
LFSH1432/LFSH1434	2.0 - 184 gpm	1-1/2"	2"	\$9,129.00	SH1432DV
LFSH1434/LFSH1434	2.0 - 251 gpm	2"	2-1/2"	\$10,305.00	SH1434DV
LFSH1435/LFSH1435	10 - 402 gpm	4"	4"	\$19,524.00	SH1435DV

Finish
Rough Bronze N/C

Piping Inlets/Outlet
Bottom/Top N/C
Top/Top \$346.00

Cabinet
Exposed, No Cabinet N/C
Stainless Steel, Recessed \$3,552.00
Stainless Steel, Wall Mounted \$3,552.00
Painted, Recessed \$3,044.00
Painted, Wall Mounted \$3,044.00

Alarm (not installed)**
None N/C
AquaSentry2 for LFMM431 \$3,744.00
AquaSentry2 for LFMM432 \$3,854.00
AquaSentry2 for LFMM433 \$3,929.00
AquaSentry2 for LFMM434 \$4,244.00
AquaSentry2 for LFMM435 \$4,244.00
AquaSentry2 for LFSH1432DV \$4,963.00
AquaSentry2 for LFSH1432HL \$4,963.00

View Port
None N/C
Window \$225.00

A	E	D	M	N	Q	R	U	0	1	2	3	4	5	6	7	0	W
---	---	---	---	---	---	---	---	---	---	---	---	---	---	---	---	---	---

*The wetted surface of this product contacted by consumable water contains less than 0.25% of lead by weight.
**Not available with LFSH1434DV, LFSH1434HL & LFSH1435DV

Note: These products are specially made and are not returnable or subject to credit.

A WATTS Brand

LEAD FREE*

Powers' High Capacity Systems are fully assembled and factory tested. They are designed to provide safe tempered water throughout commercial and institutional facilities. They consist of LFMM434 and LFSH1434 HydroGuard® XP thermostatic tempering valves. Each system includes ball valves, thermometers, pressure gauges, triple-duty check valves and PRV. Each system is supported by heavy-duty welded struts. Piping configuration is bottom inlets and top outlets.

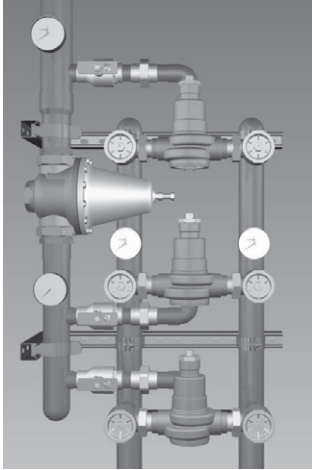

LFSH1434TVAEM0

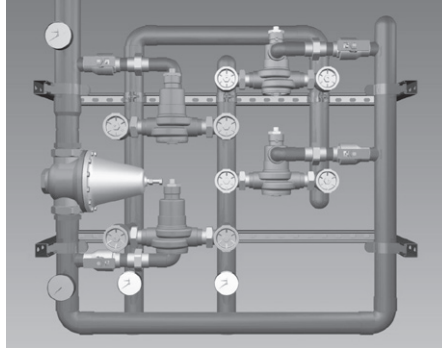

LFSH1434QVAEM0

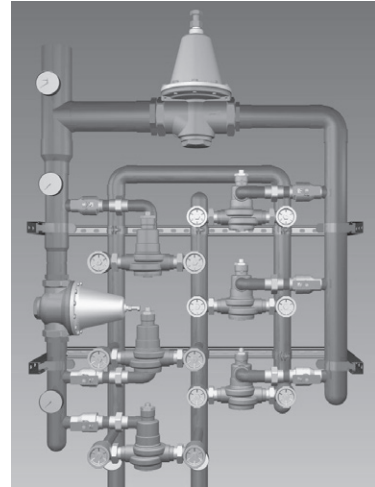

LFSH14346VAEM0



LF

Valve Configuration	Capacity	Inlets	Outlet	List Price	Order Code
1- LFSH1434 & 2- LFMM434	1.0 - 416 gpm	2-1/2"	3"	Per Application Contact POWERS	SH1434TV SH1434QV SH14346V
1- LFSH1434 & 3- LFMM434	1.0 - 559 gpm	2-1/2"	3"		
1- LFSH1434 & 5- LFMM434	1.0 - 847 gpm	2-1/2"	4"		
Finish					
Rough Bronze				N/C	A
Piping Inlets/Outlet					
Bottom/Top				N/C	E
Cabinet					
Exposed, No Cabinet				N/C	M
Stainless Steel, Wall Mounted				Per Application Contact Powers	Q
Painted, Wall Mounted					U
Alarm (Not Installed)					
None				N/A	0

Note: These products are specially made and are not returnable or subject to credit.

*The wetted surface of this product contacted by consumable water contains less than 0.25% of lead by weight.

A WATTS Brand

LEAD FREE*

The IntelliStation™ is an electronic mixing station providing user-directed control and monitoring of water distribution system. IntelliStation™ includes an electronic control module featuring a color touch screen digital display to select desired outlet water temperature, an electronically actuated valve, temperature sensors (plus a quick response temperature sensor), pressure sensors and check valves. The IntelliStation™ monitors hot supply inlet temperature, hot supply pressure, mixed outlet temperature, mixed outlet pressure, return temperature, and return pressure to help maintain the desired outlet temperature. IntelliStation™ also features a user programmable high temperature Sanitization mode to help limit water-borne bacteria as part of a user-directed and controlled thermal eradication protocol. Each IntelliStation™ is mounted on heavy-duty, welded struts as a complete unit. Optional equipment includes engineer specified circulator, flow/BTU package and strainers.

The IntelliStation™ Control Module supports building automation system (BAS) communication with BACnet® IP, BACnet® MSTP, and Modbus® protocols, allowing remote programming and data viewing.

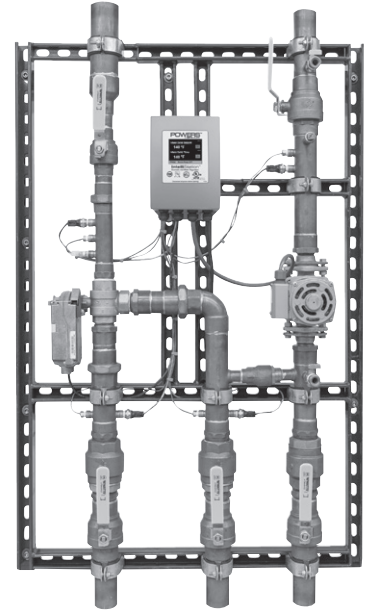

Shown with optional pump

Standard Capacity

Valve	Inlets	Outlet	Order Code
LFS150	2"	2 1/2"	LFS150
LFS200	2 1/2"	3"	LFS200

Per Application Contact Powers

Return Pipe Size	Order Code
1"	C
2"	F

Flow/BTU Package	Order Code
None	O
Flow/BTU Package	F

Strainers*	Order Code
None	O
On inlets	S

Pump	Order Code
Less Pump	LP
Pump Assigned by Factory	--

Must Provide Following Pump Information to Factory to Select the Pump:

Pump Manufacturer: _____
 Their Part/Model # _____
 System Head Loss _____
 Required Flow to Maintain Recirculating Temperature _____

High Capacity

Valve	Inlets	Outlet	Order Code
LFS150/LFS150	4"	4"	LFS150DV
LFS200/LFS200	6"	6"	LFS200DV
LFS200/LFS200/LFS200	6"	6"	LFS200TV

Per Application Contact Powers

Return Pipe Size	Order Code
3"	H

Flow/BTU Package	Order Code
None	O
Flow/BTU Package	F

Strainers*	Order Code
None	O
On inlets	S

Pump	Order Code
Less Pump	LP
Pump Assigned by Factory	--

Must Provide Following Pump Information to Factory to Select the Pump:

Pump Manufacturer: _____
 Their Part/Model # _____
 System Head Loss _____
 Required Flow to Maintain Recirculating Temperature _____

*Strainers to be installed at proper location by plumber at the job site.

LEAD FREE*

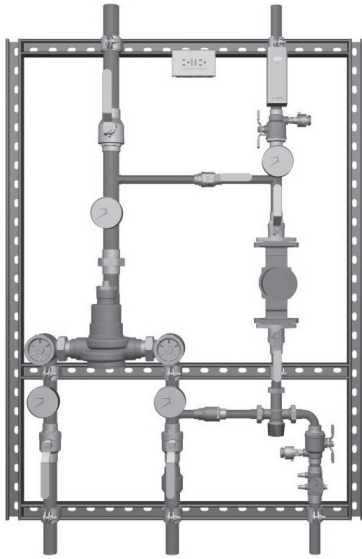

Shown with optional pump

PowerStation™ is a complete, fully assembled water tempering system, designed to provide safe tempered water throughout commercial and institutional facilities. PowerStation™ features the HydroGuard® XP LFMM430 or LFSH1430 tempering series valve with advanced thermal actuation technology. Each PowerStation™ is mounted on heavy-duty, welded struts and is factory tested as a complete system. Each PowerStation™ includes an engineer specified circulator, GFCI outlet, combination temperature/pressure gauges and Powers' triple-duty checkstops and internal bypass loop for fast and easy set-up. Optional equipment includes an Aquastat and/or Powers' exclusive automatic balancing valve.



Valve	Capacity	Inlet	Outlet
LFSH1432	1 - 57 gpm	3/4"	1"
LFSH1434	1 - 127 gpm	1-1/4"	1-1/2"
LFSH1435	5 - 201 gpm	2"	2"
LFMM431	3 - 42 gpm	3/4"	3/4"
LFMM432	4 - 64 gpm	3/4"	1"
LFMM433	5 - 110 gpm	1-1/4"	1-1/4"
LFMM434	7 - 144 gpm	1-1/4"	1-1/2"
LFMM435	10 - 208 gpm	2"	2"

List Price
Per Application Contract Powers

Controls

None	O
Aquastat	A
AquaSentry2**	B
Aquastat & AquaSentry2**	C

Balancing Valves

None	O
Automatic Balancing Valve	B

Return Pipe Size

1/2"	A
3/4"	B
1"	C
1-1/4"	D
1-1/2"	E
2"	F

Assigned by Factory

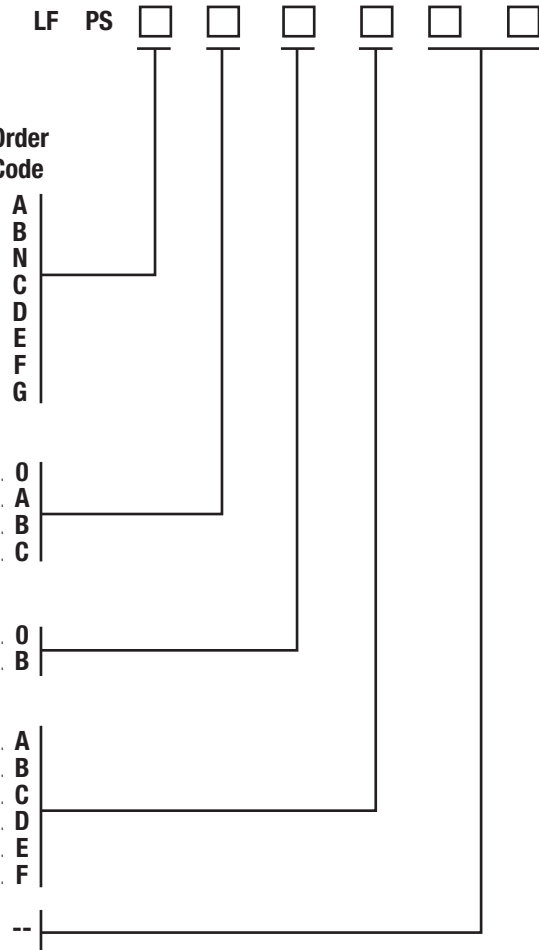

Pump Information:

Call Powers Technical Service at 800-669-5430 for pump selection. You must provide the following information. Pump shall be lead free.

System Head Loss _____

Required Flow to Maintain Recirculating Temp. _____

Note: These products are specially made and are not returnable or subject to credit.

*The wetted surface of this product contacted by consumable water contains less than 0.25% of lead by weight.
**AquaSentry2 - not installed

A **WATTS** Brand

LEAD FREE*

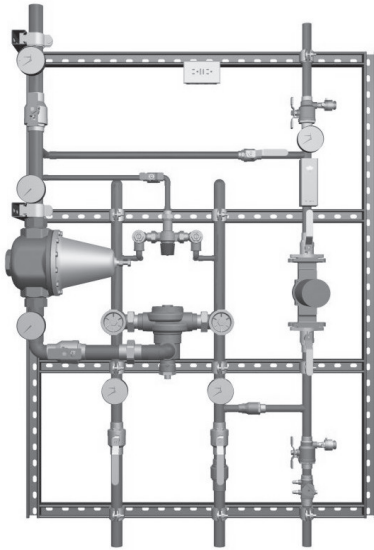

PowerStation™ is a complete, fully assembled water tempering system, designed to provide safe tempered water throughout commercial and institutional facilities. PowerStation™ features the HydroGuard® XP LFLM490, LFMM430 and/or LFSH1430 tempering series valve with advanced thermal actuation technology. Each PowerStation™ is mounted on heavy-duty, welded struts and is factory tested as a complete system. It also includes an engineer specified circulator, GFCI outlet, combination temperature/pressure gauges, Powers' triple-duty checkstops and internal bypass loop for fast and easy set-up. Optional equipment includes an Aquastat and/or Powers' exclusive automatic balancing valve.

Shown with optional pump



Valve	Capacity	Inlets	Outlet
LFMM431HL	0.5 - 65 gpm	3/4"	3/4"
LFMM432HL	0.5 - 87 gpm	3/4"	1"
LFMM433HL	0.5 - 133 gpm	1-1/4"	1-1/4"
LFMM434HL	0.5 - 167 gpm	1-1/4"	1-1/2"
LFMM435HL	3 - 186 gpm	1-1/4"	1-1/2"
LFSH1432HL	1 - 201 gpm	1-1/2"	2"
LFSH1434HL	1 - 271 gpm	2"	2-1/2"
LFSH1432DV	2 - 184 gpm	1-1/2"	2"
LFSH1434DV	2 - 251 gpm	2"	2-1/2"
LFSH1434TV	1 - 416 gpm	2-1/2"	3"
LFSH1435DV	10 - 402 gpm	4"	4"

List Price

Per Application Contact POWERS

Controls

None	O
Aquastat	A
AquaSentry2**	B
Aquastat & AquaSentry2**	C

Balancing Valve

None	O
Automatic Balancing Valve	B

Return Pipe Size

1/2"	A
3/4"	B
1"	C
1-1/4"	D
1-1/2"	E
2"	F

Assigned by Factory

LF	PS	<input type="checkbox"/>	<input type="checkbox"/>	<input type="checkbox"/>	<input type="checkbox"/>	<input type="checkbox"/>	<input type="checkbox"/>
Order Code	H	J	K	L	M	P	Q
	S	T	W	X	O	A	B
	C	O	B	A	B	C	D
	E	F	A	B	C	D	E
	F	A	B	C	D	E	F
	--	A	B	C	D	E	F

Pump Information:

Call Powers Technical Service at 800-669-5430 for pump selection. You must provide the following information. Pump shall be lead free.

System Head Loss _____

Required Flow to Maintain Recirculating Temp. _____

Note: These products are specially made and are not returnable or subject to credit.

*The wetted surface of this product contacted by consumable water contains less than 0.25% of lead by weight.
 **AquaSentry2 - not installed and not available on LFSH1434HL, LFSH1434DV, LFSH1434TV, LFSH1435DV.

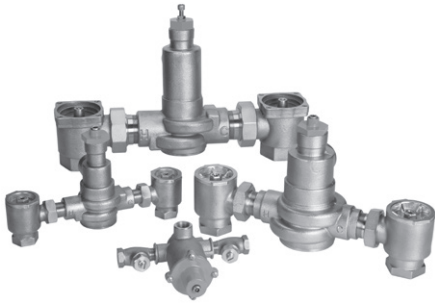

The HydroGuard® XP Emergency Tempering valves, with cold water bypass, are designed to use with emergency fixtures in compliance with ANSI Z358.1 2014 and are ASSE 1071 listed. Valves feature advanced paraffin actuation technology, dirt and lime resistant poppet and seat design and vandal resistant locking mechanism. Valves are available in two finishes.



Valve	Valve Only	
	Rough Bronze	Chrome Plated
ES150 1/2 x 1/2	ES150-10 \$1,455.00	ES150-20 \$1,614.00
ETV200 3/4 x 1	ETV200-10 \$1,564.00	ETV200-20 \$1,737.00
ETV400 1 1/4 x 1 1/2	ETV400-10 \$2,293.00	ETV400-20 \$2,499.00
ETV500 2 x 2	ETV500-10 \$3,415.00	ETV500-20 \$3,702.00

Valve	Valve w/Temperature/Pressure Gauge on Outlet	
	Rough Bronze	Chrome Plated
ES150 1/2 x 1/2	ES150-11 \$1,488.00	ES150-22 \$1,671.00
ETV200 3/4 x 1	ETV200-13 \$1,691.00	ETV200-24 \$2,084.00
ETV400 1 1/4 x 1 1/2	ETV400-15 \$2,837.00	ETV400-26 \$3,178.00
ETV500 2 x 2	ETV500-17 \$3,178.00	ETV500-28 \$4,389.00

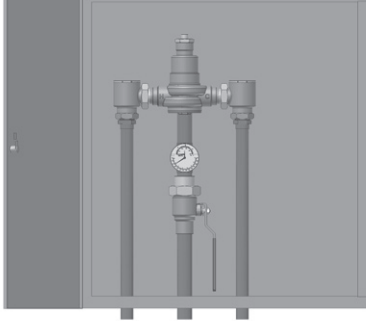

The HydroGuard® XP Emergency Tempering valves, with cold water bypass, are designed to use with emergency fixtures in compliance with ANSI Z358.1 2004 and are ASSE 1071 listed. Valves feature advanced paraffin actuation technology, dirt and lime resistant poppet and seat design and vandal resistant locking mechanism. Valves are available in two finishes.



	ES150	ETV200	ETV400	ETV500	Ordering Code
Valve and Piping Finish					
Rough Bronze	\$ 1,668.00	\$ 1,860.00	\$ 3,120.00	\$ 4,312.00	A
Chrome Plated	\$ 1,882.00	\$ 2,130.00	\$ 3,607.00	\$ 4,909.00	B
Piping Inlets/Outlet					
Top/Top	N/C	N/C	N/C	N/C	D
Top/Bottom	N/C	N/C	N/C	N/C	E
Bottom/Top	N/C	N/C	N/C	N/C	F
Bottom/Bottom	N/C	N/C	N/C	N/C	G
Bottom/Side	N/C	N/C	N/C	N/C	
Cabinet Style					
Exposed, no cabinet	N/C	N/C	N/C	N/C	O
Stainless Steel, Recessed	\$ 1,209.00	\$ 2,141.00	\$ 2,141.00	\$ 2,486.00	N
Stainless Steel, Semi-Recessed	\$ 1,209.00	\$ 2,141.00	\$ 2,141.00	\$ 2,486.00	P
Stainless Steel, Wall Mounted	\$ 1,209.00	\$ 2,141.00	\$ 2,141.00	\$ 2,486.00	Q
Painted, Recessed	\$ 1,110.00	\$ 1,229.00	\$ 1,229.00	\$ 1,629.00	R
Painted, Semi-Recessed	\$ 1,110.00	\$ 1,229.00	\$ 1,229.00	\$ 1,629.00	T
Painted, Wall Mounted	\$ 1,110.00	\$ 1,229.00	\$ 1,229.00	\$ 1,629.00	U
Option					
None	N/C	N/C	N/C	N/C	0
T/P Gauge on Inlets	\$ 219.00	\$ 256.00	\$ 324.00	\$ 405.00	5
Alarm System (not installed)					
None	N/C	N/C	N/C	N/C	0
AquaSentry2	\$ 1,857.00	\$ 1,857.00	\$ 2,324.00	\$ 3,615.00	4
View Port					
None	N/C	N/C	N/C	N/C	0
Window	\$ 225.00	\$ 225.00	\$ 225.00	\$ 225.00	W

Note: These products are made to order (MTO) and are not returnable or subject to credit.

Hydropanel II Modular Shower Systems with e700 T/P Series Valve

Hydropanel II Shower Systems are constructed from stainless steel. They feature HydroGuard T/P Series e700 combination mixing valves with ABS or Metal handles, vandal-resistant fasteners, color-coded graphics, end caps, and are factory-tested and pre-assembled.









Model 4507100









Model 4507054 

Hydropanel II with e705 Combination Mixing Valves with ABS Handles

Description	Order Code	Weight (lbs.)	List Price
Fixed Showerhead and Soap Dish	4507050	15.0	\$1,628.00
Fixed Showerhead, less Soap Dish	4507051	14.0	\$1,628.00
Swivel Showerhead and Soap Dish	4507052	15.0	\$1,628.00
Swivel Showerhead, less Soap Dish	4507053	14.0	\$1,628.00
Professional Hand Shower, Glide Rail, VB and Soap Dish 	4507054	17.0	\$1,922.00
Professional Hand Shower, Glide Rail, VB, less Soap Dish 	4507055	16.0	\$1,922.00
Deluxe Hand Shower, Glide Rail, VB and Soap Dish 	4507056	18.0	\$1,973.00
Deluxe Hand Shower, Glide Rail, VB, less Soap Dish 	4507057	17.0	\$1,973.00
Professional Hand Shower, Glide Rail, VB, Fixed Showerhead and Soap Dish 	4507058	18.0	\$2,028.00
Professional Hand Shower, Glide Rail, VB, Swivel Showerhead and Soap Dish 	4507059	19.0	\$2,028.00

Hydropanel II with e710 Combination Mixing Valves with Metal Handles

Description	Order Code	Weight (lbs.)	List Price
Fixed Showerhead and Soap Dish	4507100	15.0	\$1,625.00
Fixed Showerhead, less Soap Dish	4507101	14.0	\$1,625.00
Swivel Showerhead and Soap Dish	4507102	15.0	\$1,625.00
Swivel Showerhead, less Soap Dish	4507103	14.0	\$1,625.00
Professional Hand Shower, Glide Rail, VB and Soap Dish 	4507104	17.0	\$1,589.00
Professional Hand Shower, Glide Rail, VB, less Soap Dish 	4507105	16.0	\$1,589.00
Deluxe Hand Shower, Glide Rail, VB and Soap Dish 	4507106	18.0	\$1,982.00
Deluxe Hand Shower, Glide Rail, VB, less Soap Dish 	4507107	17.0	\$1,982.00
Professional Hand Shower, Glide Rail, VB, Fixed Showerhead and Soap Dish 	4507108	18.0	\$2,034.00
Professional Hand Shower, Glide Rail, VB, Swivel Showerhead and Soap Dish 	4507109	19.0	\$2,034.00

Hydropanel II Modular Shower Systems

Hydropanel II Shower Systems are constructed from stainless steel. They feature a pressure balance or thermostatic mixing valve with metal lever handle, vandal-resistant fasteners, color-coded graphics, end caps, and are factory-tested and pre-assembled.



Model 4504002





Model 4504210E 





Model 4500416P 



Hydropanel II with Biltmore 900 Pressure Balancing Valve

	Order Code	Weight (lbs.)	List Price
Hydropanel II with Fixed Showerhead and Soap Dish	4504000	15.0	\$1,731.00
Hydropanel II with Fixed Showerhead, less Soap Dish	4504001	14.0	\$1,731.00
Hydropanel II with Swivel Showerhead and Soap Dish	4504002	15.0	\$1,731.00
Hydropanel II with Swivel Showerhead, less Soap Dish	4504003	14.0	\$1,731.00
Hydropanel II with Professional Hand Shower, Glide Rail, VB and Soap Dish 	4504004	17.0	\$1,893.00
Hydropanel II with Professional Hand Shower, Glide Rail, VB, less Soap Dish 	4504005	16.0	\$1,893.00
Hydropanel II with Deluxe Hand Shower, Glide Rail, VB and Soap Dish 	4504006	18.0	\$1,944.00
Option: Metering Valve Only	Suffix M		Add: \$477.00
Metering Valve with Pressure Balancing	Suffix MP		Add: \$607.00

Hydropanel II with HydroGuard PB410 Pressure Balancing Valve

Hydropanel II with Fixed Showerhead and Soap Dish	4500416P	15.0	\$2,058.00
Hydropanel II with Fixed Showerhead, less Soap Dish	4500417P	14.0	\$2,058.00
Hydropanel II with Swivel Showerhead and Soap Dish	4500418P	15.0	\$2,058.00
Hydropanel II with Swivel Showerhead, less Soap Dish	4500419P	14.0	\$2,058.00
Hydropanel II with Hand Shower VB and Soap Dish 	4500420P	17.0	\$2,026.00
Hydropanel II with Hand Shower, VB, less Soap Dish 	4500421P	16.0	\$2,026.00
Hydropanel II with Diverter, Deluxe Hand Shower, VB, Fixed Showerhead, and Soap Dish 	4504104P	17.0	\$3,339.00

Hydropanel II with HydroGuard e420 Thermostatic Mixing Valve

Hydropanel II with Fixed Showerhead and Soap Dish	4504210E	15.0	\$2,266.00
Hydropanel II with Fixed Showerhead, less Soap Dish	4504211E	14.0	\$2,266.00
Hydropanel II with Swivel Showerhead and Soap Dish	4504212E	15.0	\$2,266.00
Hydropanel II with Swivel Showerhead, less Soap Dish	4504213E	14.0	\$2,266.00
Hydropanel II with Hand Shower VB and Soap Dish 	4504214E	17.0	\$2,607.00
Hydropanel II with Hand Shower, VB, less Soap Dish 	4504215E	16.0	\$2,607.00

A WATTS Brand

	Order Code	Weight (lbs.)	List Price
Hydropanel II Dual Shower with Diverter			
Hydropanel II with Diverter, Deluxe Hand Shower, VB, Fixed Showerhead and 900 Series Pressure Equalizing Valve, Soap Dish 	4504103	22.0	\$3,552.00
Hydropanel II Tub/Shower with Biltmore 900 Pressure Balancing Valve			
Hydropanel II with Fixed Showerhead, Diverter Spout and 900 Series Pressure Equalizing Valve with Soap Dish	4504031	22.0	\$2,026.00
Hydropanel II Modular Shrouding System			
Horizontal Adaptor Kit, 16"	4504040	3.8	\$286.00
Horizontal Adaptor Kit, 24"	4504041	6.9	\$329.00
Horizontal Adaptor Kit, 48"	4504042	13.0	\$365.00
Overlay Shroud Kit, 8"	4504043	1.6	\$176.00
Overlay Shroud Kit, 13"	4504044	2.6	\$192.00
Overlay Shroud Kit, 16"	4504045	3.7	\$200.00
Overlay Shroud Kit, 18"	4504046	4.2	\$207.00
Overlay Shroud Kit, 23"	4504047	6.4	\$237.00
Overlay Shroud Kit, 28"	4504048	5.5	\$249.00
Extension Shroud Kit, 6"	4504050	1.6	\$166.00
Extension Shroud Kit, 24"	4504051	4.2	\$235.00
Corner Shroud Kit, 10"	4504049	2.2	\$183.00
Corner MTG Kit	4500430	1.0	NLA
Corner End Cap	4504015	0.7	NLA
End Cap Kit	4504011	0.1	\$46.00

*Parts discount applies

See page 30 for ESP™ Infrared and Piezo Proximity Hydropanel Systems.

HydroGuard® ESP Infrared Showers

Powers ESP Infrared Showers are supplied complete with the sensor assembly, 24 VAC solenoid valve, modular junction box and mounting hardware. Optional box mount or plug-in transformer available. Hand showers and diverters are optional as well.



HydroGuard® Piezo Sensor Showers

Powers ESP Piezo Showers are supplied complete with 24 VAC solenoid valve, installation kit, and control box. Optional box-mount or plug-in transformer available. (Piezo shower is also available for multiple shower applications.)



ADA compliant

	List Price
Sensor	
Infrared	\$1,530.00
Piezo	NLA
for wall depth 0-.25"	NLA
for wall depth .26"-1.5"	\$1,231.00
for wall depth 1.6"-4.5"	\$1,267.00
for wall depth 4.6"-6.5"	\$1,288.00
for wall depth 6.6"-8.5"	\$1,320.00
Transformer (Order separately-See below)	
None	N/C
Control Box	
Individual Control (For Piezo)	N/C
Less Box (For Infrared)	N/C
Showerhead	
None	N/C
Adj. Brass/Arm and Flange (141 377)	\$84.00
Adj. Brass/Arm and Flange (141 376)	\$187.00
Institutional (141 381)	\$382.00
Institutional (141 868)	\$382.00
Institutional (141903A)	\$345.00
Institutional (141903B)	\$345.00
Institutional (141903C)	\$345.00
Institutional (141903D)	\$345.00
Hand Shower	
None	N/C
Deluxe (141 163) w/VB	\$462.00
Standard (141 827) w/VB	\$312.00
Diverter	
None	N/C
Concealed (141600B)	\$222.00
Concealed (141600E)	\$163.00
Concealed (141600F)	\$177.00
Transformer (Powers up to 1 solenoid)	
Box (444 119)	\$94.00
Plug (444 118)	NLA

447-

Order Code

1 |

3 |

4 |

5 |

6 |

7 |

00 |

IC |

00 |

00 |

K1 |

M1 |

NO |

PO |

QO |

RO |

SO |

TO |

0 |

6 |

8 |

0 |

Y |

A |

B |

A **WATTS Brand**

Hydropanel ESP Infrared Showers

Powers Hydropanel ESP Infrared Showers are supplied complete with the sensor assembly and 24 VAC solenoid valve pre-piped in a stainless steel shroud. Modular junction box and mounting hardware included, as well as optional box mount or plug-in 24 VAC transformer.



Hydropanel ESP Piezo Showers

Powers Hydropanel ESP Piezo Showers are supplied complete with the assembly, proximity sensor assembly, and 24 VAC solenoid valve, pre-piped in a stainless steel shroud. Control box and mounting hardware included.

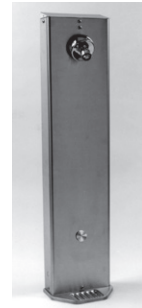

ADA compliant

Sensor	List Price
Infrared	\$ 2,779.00
Piezo	\$ 2,347.00

Transformer (Order separately-See below)

None	N/C
------------	-----

Control Box

Individual Control (Push Button)	N/C
Less Box (Infrared only)	N/C

Showerhead

Fixed Head	N/C
Swivel Head	N/C
Professional Hand Shower (141 318) w/VB	\$ 279.00
Deluxe Hand Shower (141 163) w/VB	\$ 462.00
Standard Hand Shower (141 827) w/VB	\$ 312.00
Fixed Head, Standard Hand Shower, VB and Diverter	\$ 646.00
Fixed Head, Deluxe Hand Shower, VB and Diverter	\$ 760.00

Soap Dish

With Soapdish	N/C
Less Soapdish	N/C

Transformer (Powers up to 1 solenoid)

Box (444 119)	\$ 94.00
Plug (444 118)	N/A

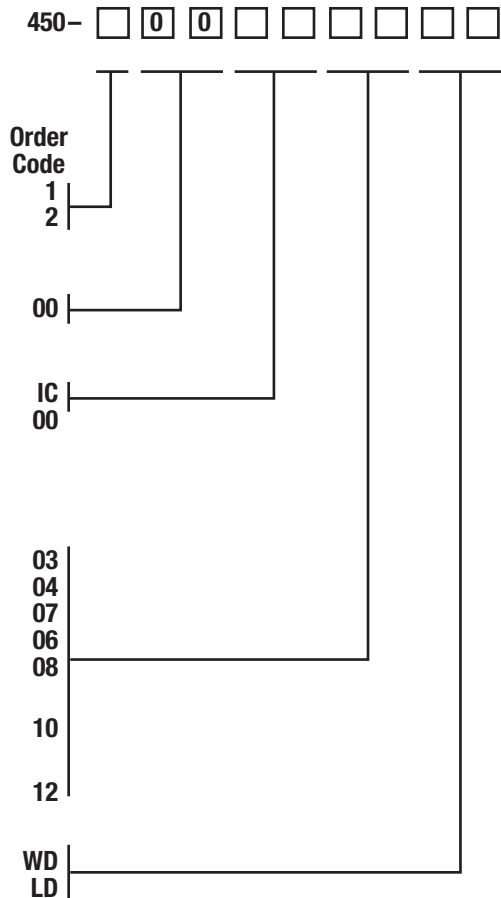

A WATTS Brand

LEAD FREE*

AquaSentry® 2 Series LF460 Alarm System

Audibly and visibly warns and shuts down supply if water temperature exceeds high or low set-points.

AquaSentry 2 Alarm System, complete

Includes the AquaSentry 2 control module, temperature sensor with phone-style jack, sensor junction box, 4 x 4 electrical box, UL/CSA approved 24 VAC, class 2 transformer, and 25 feet of station cable.

Order Code	Weight	List Price
LF4600150	8.0 lbs.	\$1,472.00

Motorized Ball Valve, cable, and shock absorber must be ordered separately. See below.

Accessories for AquaSentry 2

Motorized Ball Valves - 24 VAC

	Order Code	Weight	List Price
1/2"	LF460070	9 lbs.	\$1,545.00
3/4"	LF460071	10 lbs.	\$1,710.00
1"	LF460072	11 lbs.	\$1,720.00
1-1/4"	LF460073	11 lbs.	\$1,761.00
1-1/2"	LF460074	12 lbs.	\$1,841.00
2"	LF460075	14 lbs.	\$2,987.00

Cable

Telephone station cable

Order Code	List Price
460 339	\$2.40/foot

Shock Absorber

1" NPT, stainless steel, nitrogen-charged.

Order Code	Weight	List Price
460 353	1.0 lbs.	\$745.00

Components

460 602	AquaSentry 2 Transformer, Class 2, 24 VAC, UL/CSA-approved, 4 lbs.	\$296.00
460 601	Temperature Sensor with Phone Jack	\$314.00

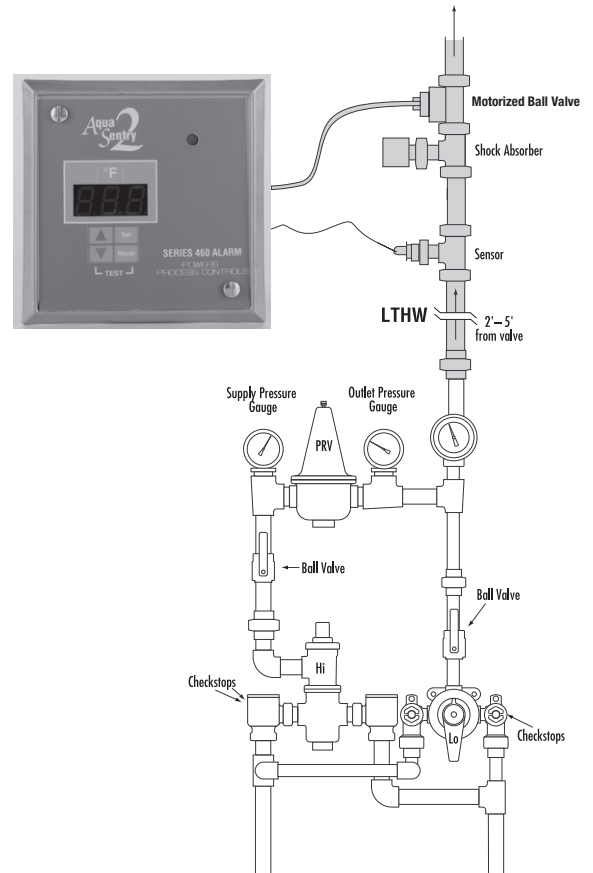

*The wetted surface of this product contacted by consumable water contains less than 0.25% of lead by weight.

Fotoguard and Fotopanel Series 440

For precise control of water temperature for photographic processing.



Fotoguard

Fotopanel



Fotoguard

Description	Order Code	Capacity	Outlets	Weight	List Price
Concealed—Stainless steel faceplate with temperature indication, volume control, inlet strainer checkstops.	4401550	1–6 gpm	1/2"	7.5 lbs.	\$1,455.00
Exposed—Chrome-plated finish, inlet strainer checkstops, volume control.	4401500	1–6 gpm	1/2"	7.8 lbs.	\$1,692.00
	4401510	5–14 gpm	1/2"	9.5 lbs.	\$2,037.00

Fotoguard Supply Fixtures

Chrome-plated finish, inlet strainer checkstops, volume control, shut-off valve, vacuum breaker, and dial thermometer.	1311575	1–6 gpm	1/2"	20.0 lbs.	\$2,900.00
	1311813	5–14 gpm	1/2"	23.0 lbs.	\$3,168.00

Fotopanel

Stainless steel cabinet includes T/P valve, temperature adjustment, inlet strainer checkstops, On/Off valve, volume control, dial thermometer, vacuum breaker.	4401000	1–6 gpm	1/2"	17.0 lbs.	\$3,157.00
	4403000	5–14 gpm	1/2"	21.0 lbs.	\$3,480.00
Same as 440-1000 with recessed cabinet.	4401020	1–6 gpm	1/2"	17.0 lbs.	\$3,411.00
Optional temperature ranges; add appropriate suffix code.	40° to 90°F	Suffix code: W			Add: \$140.00
	120° to 175°F	Suffix code: V			Add: \$140.00



High Temperature Shutoff Device

	Type	Order Code	Weight (lbs.)	List Price
Showers high temperature shut-off device used between shower arm and shower head.	—	HT115	0.3	\$72.00
115°F limit. Automatic reset. ASSE 1062 listed.				

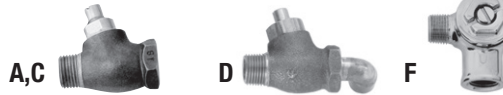

Checkstops (sold in pairs)

Straight, 1/2" IPS, Concealed	A	141 176	1.1	\$84.00
Straight, 1/2" IPS, Exposed, Polished Chrome	B	141 177	1.0	NLA
Straight, 1/2" Sweat, Concealed	C	141 187	1.1	\$84.00
Angled, 1/2" Sweat, Concealed	D	141 326	1.3	\$201.00
Angled, with Strainer, 1/2" IPS, Concealed	E	230 046	2.5	\$286.00
Angled, with Strainer, 1/2" IPS, Exposed, Polished Chrome	F	230 048	2.4	\$444.00
Straight, 1/2" IPS, Rough Chrome	G	141 307	1.1	NLA



Showerheads

Economizer, Chrome-Plated ABS, Adjustable	J	141 371	0.5	\$25.00
Standard, Chrome-Plated Brass, Adjustable	K	141 377	0.7	\$58.00
Large, Chrome-Plated Brass, Adjustable	M	141 376	1.1	\$94.00
Low Flow (1.6 gpm) Shower Head, Chrome-Plated	G	141 800	2.5	\$108.00
Low Flow (1.5 gpm) Shower Head, Chrome-Plated	H	141 801	0.5	\$79.00
Massage Showerhead, Polished Chrome	—	141 803	0.9	NLA
Adjustable, Brass Ball Joint Showerhead, Polished Chrome	—	141 353	1.5	NLA
Standard, Chrome-Plated Brass, Adjustable, 1/2" Male Thread	—	141 378	0.7	\$57.00
Large, Chrome-Plated Brass, Adjustable, 1/2" Male Thread	—	141 379	1.1	\$105.00



Institutional Showerheads

	Type	Order Code	Weight (lbs.)	List Price
30° Fixed Head with Screwed/Sweat Connections	—	141 381	3.1	NLA
Wall-Mounted, 25°, Fixed Head with 5° Adjustment Feature, Vandal-Resistant	—	141 868	2.0	\$382.00
Fixed Showerhead, Adjustable Spray, Chrome-Plated, Brass	—	141 816	1.0	\$192.00
Fixed Showerhead, Adjustable Spray, Chrome-Plated, Brass, 1.5gpm	—	141 817	1.0	\$192.00
Small Ball Joint Shower Head with Wall Bracket, Anchor Plate, and Adjustable Spray, Chrome Plated, Brass	—	141903A	3.0	\$345.00
Large Ball Joint Shower Head with Wall Bracket, Anchor Plate, and Adjustable Spray, Chrome Plated, Brass	—	141903B	3.2	\$345.00
Fixed Showerhead with Wall Bracket, Anchor Plate, and Adjustable Spray, Chrome-Plated, Brass	—	141903C	2.7	\$345.00
Fixed Showerhead with Wall Bracket, Anchor Plate, and Adjustable Spray, Chrome-Plated, Brass, 1.5 gpm	—	141903D	2.7	\$345.00

A WATTS Brand



Arm and Flange Kits

	Code	(lbs)	Price
Standard Arm and Flange 1	141 399	0.3	\$27.00
Deluxe Arm and Flange (with set screw on flange) 2	141 198	0.4	\$45.00

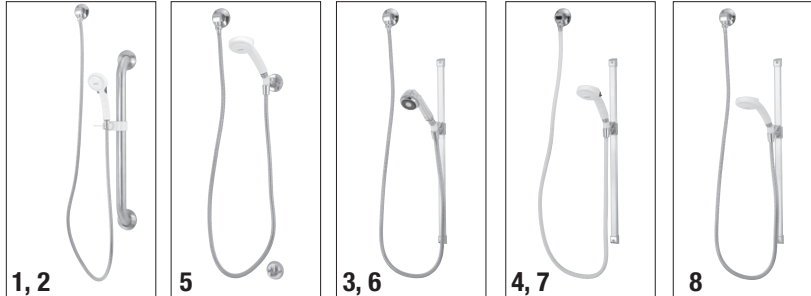

Hand Shower Systems

24" Stainless Steel ADA Wall Grab Bar, Regular Hand Shower, Shower System	—	141 180	4.7	NLA
24" Stainless Steel ADA Wall Grab Bar with Shower System	1	141 174	4.7	\$464.00
36" Stainless Steel ADA Wall Grab Bar with Shower System	2	141 175	5.5	\$488.00
Deluxe, Metal Hose, 30" Glide Rail	3	141 919	3.5	\$524.00
Professional, Vinyl Hose, 30" Glide Rail Bar, Push Button	4	141 921	2.7	\$447.00
Standard, Metal Hose, Two Wall Hooks	5	141 161	2.0	\$185.00
Deluxe, Metal Hose, 24" Glide Rail	6	141 163	3.1	\$427.00
Professional, Vinyl Hose, 24" Glide Rail, Push Button	7	141 318	2.3	\$244.00
Standard, Metal Hose, 24" Glide Rail	8	141 827	2.3	\$278.00
European, Metal Hose, 23" Wall Bar	9	141 918	2.0	NLA
Deluxe, Metal Hose, 48" Wall Bar	—	141 757	4.0	NLA
Standard, Metal Hose, 30" Glide Rail	N	141 879	2.8	\$410.00
Low Flowl (1.5g pm) Massage Metal Hose, , 30" Glide Rail	L	141 150	5.06	\$594.00
Professional, Stainless Steel Hose, 24" Glide Rail, Push Button	—	141 912	2.3	\$450.00
Professional, Metal Hose, 24" Glide Rail, Push Button	—	141 851	2.3	NLA
Standard, Metal Hose, 30" Glide Rail	—	141 693	4.0	NLA
Deluxe Hand Shower*	—	141163A	1.0	\$198.40
Hand Shower*	—	141161A	0.5	\$27.20
Hand Shower with Push Button*	—	141318A	0.3	\$35.40
24" Glide Rail*	—	141163D	0.9	\$138.60
30" Glide Rail*	—	141 731	1.7	\$262.20
60" Double Spiral Metal Hose*	—	141161B	1.0	\$70.70
60" Reinforced Vinyl Hose*	—	141318B	0.9	\$83.00
Swivel Connector*	—	141161C	0.3	\$34.10
Pin Style Wall Mount with Screw Mount*	—	141161D	0.2	\$34.40
1/2" Chrome-Plated Elbow with Wall Flange*	—	141 320	1.0	\$100.80
Quick-Release Hose Coupling (Quick Disconnect)	—	141804A	0.4	\$111.00

NOTE: All metal hose are expandable from 60 - 80".

*Parts Discount Applies

A WATTS Brand

Tub Spouts	Q	R	S	T	U
Diverter, Chrome-Plated Brass, 3/4" IPS	Q				
Non-Diverter, Chrome-Plated, 1/2" IPS		R			
Diverter, Chrome-Plated, 1/2" IPS			S		
Diverter, Chrome-Plated Brass, 1/2" IPS				T	
Diverter, Chrome-Plated, 1/2" Slip-fit					U
				141 159	1.2 \$111.00
				141 171	0.4 \$38.00
				141 349	0.7 \$53.00
				141 350	1.3 \$119.00
				141 409	1.0 \$46.00

Diverter	141600B	141600E	141600F	Z	
Concealed Diverter Valve, 3-Port, 1/2" Sweat, Metal Handle	Y				
Concealed Diverter Valve, 3-Port, 1/2" Sweat, Deluxe ABS Handle		A			
Concealed Diverter Valve, 3-Port, 1/2" Sweat, Deluxe Metal Handle			B		
Exposed Diverter, 3-Port, Shower Arm-Type				Z	
				141600B	2.0 \$222.00
				141600E	3.0 \$163.00
				141600F	3.0 \$177.00
				141 700	0.5 \$46.00

Vacuum Breakers	V	W	043834A		
Wall-Mounted Vacuum Breaker, Chrome-Plated Finish, Elevated	V				
In-Line Vacuum Breaker		W			
Vacuum Breaker, 1/2" NPT Bottom Inlet, 1/2" NPT Side Outlet, Polished Chrome			—		
				131 258	2.0 \$372.00
				141 319	0.4 \$36.00
				043834A	— NLA

Volume Control Valves			
Concealed, 1/2" IPS	975 170	1.0	\$244.00
Showerhead Volume Regulator*	141 305	0.5	NLA

Dial Thermometers	8943709	8943928	8943897	
Thermometers with Bulb for Liquid Exposure:				
3-Color Dial, 1-1/16" Bulb. Scale is 0 to 200°F (-20 to 90°C)	8943709			
3-Color Dial, Horizontal Bulb. Scale is 0 to 200°F (-20 to 90°C)		8943928		
Black Dial, 1-7/8" Bulb. °F Scale. 30 to 130°F			8943897	
Combination Thermometer, 1/2" T/P Thermometer. 0 to 200 psi, 60 to 320°F	131 123			
				0.5 \$93.00

Metering Valve			
Metering Valve - Shower	141 820	3.6	\$909.00

*Parts Discount Applies

A WATTS Brand

To determine the price of a complete #11 Regulator, add the price of the desired lower housing (below) to the price of the desired thermal system (page 37)

595 - -

Lower Housing

Determine the order code from the lower housing assembly code chart (below). eliminate the 590 prefix when ordering a complete regulator

Thermal system

Determine the order code from the thermal system code chart (page 36). Eliminate the 700 prefix when ordering a complete regulator

#11 Lower Housing Assemblies

590 -

Seat	Packing	Valve Type		Order Code
		Body	Trim	
Single Comp	EP (Heating)	Bronze	Bronze	CD
Single	TFE (H) EP (C)	Bronze	Stainless	ST
Double	EP (H&C)	Bronze	Bronze	DB
Double	TFE (H) EP (C)	Bronze	Stainless	DS
Mixing	EP (Mixing)	Bronze	Bronze	WM

Size	Style					Order Code
	CD	ST	DB	DS	WM	
1/2" A	-	-	-	-	-	A50
1/2" B	-	-	-	-	-	B50
1/2" C	-	-	-	-	-	C50
1/2" D	-	-	-	-	-	D50
1/2"	1,122.00	1,221.00	-	-	-	50
3/4"	1,188.00	1,276.00	-	-	-	75
1"	1,459.00	1,596.00	1,859.00	2,329.00	1,472.00	100
1-1/4"	1,698.00	-	1,991.00	2,539.00	1,715.00	125
1-1/2"	1,962.00	-	2,295.00	2,579.00	1,980.00	150
2"	-	-	3,114.00	4,078.00	2,640.00	200

Pricing: To determine the list price and availability of the selected lower housing, locate the size and style desired in the chart above. The number corresponding to your selection is your list price. If a list price is not shown for your selection, then your selection is not available in the size and style chosen.

Valve Action

Heating (not available in WM body style) H
 Cooling (not available in type CD and WM body style) C
 Mixing (WM only) M

Order Code

Note: These products are made to order and are not returnable or subject to credit.

A WATTS Brand

Bulb and Capillary Material	Price
Copper (with 8" capillary)	\$ 1,212.00
Stainless Steel (with 8" capillary)	\$ 2,346.00

Capillary Length	
8'	N/C
15' (copper)	\$ 250.00
15' (stainless steel)	\$ 418.00
30' (copper)	\$ 375.00
30' (stainless steel)	\$ 1,097.00

Bulb Style	
Fixed Union	N/C
No Pipe Fittings	N/C
Adj. Union (N/A in "H" head)	\$ 260.00
D Vertical	\$ 180.00

• All other bodies	
Non-Indicating	N/C
Indicating	\$ 245.00

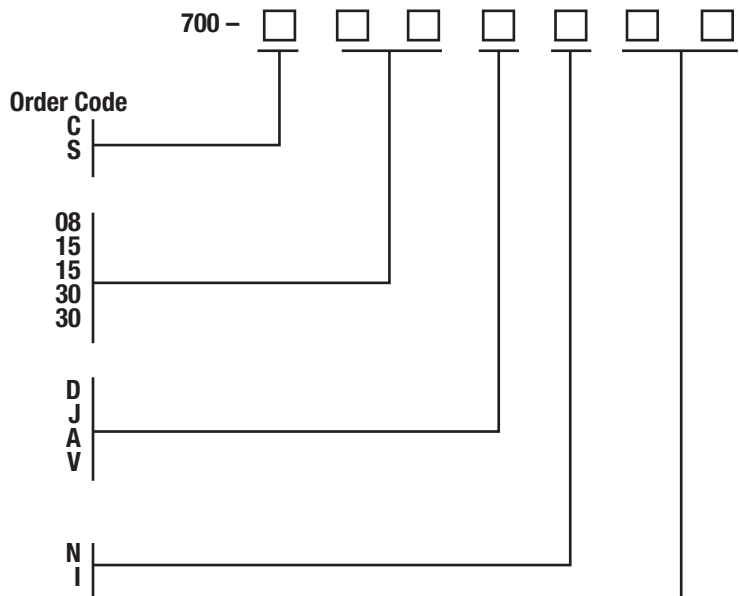

Range/Bulb Size Code (two-digit codes below)

All ranges/bulb sizes listed below are **no charge**. Select range with setpoint in **upper third** for best performance. Consult factory for ranges/bulb sizes not listed.

**Temperature Ranges
Single or Double Seat Valves
Sizes 1/2" through 2"**

Range/Bulb Size Codes	Heating D.A.	Cooling R.A.	Water Mix 1/2" to 2"
01	10° to 70°F	0° to 60°F	10° to 60°F
1" x 20" Bulb 02	55° to 115°F	45° to 105°F	55° to 115°F
03	85° to 145°F	70° to 130°F	80° to 140°F
04		90° to 150°F	100° to 160°F
05	110° to 170°F	110° to 150°F	110° to 160°F
06	06 no longer available. Substitute either 05 or 07		
1" x 9" Bulb 07	140° to 200°F	120° to 180°F	135° to 195°F
08	170° to 230°F	150° to 210°F	160° to 220°F
09	200° to 250°F	180° to 245°F	200° to 250°F
10	230° to 290°F	220° to 280°F	230° to 280°F
11	270° to 330°F	255° to 315°F	260° to 320°F

**Temperature Ranges
Double Seat
Valve Sizes 2 - 1/2" through 4"**

Range/Bulb Size Codes	Heating D.A.	Cooling R.A.	Water Mix
12	10° to 70°F	0° to 60°F	Not applicable
1-1/4" Bulb 13	55° to 115°F	45° to 105°F	
x 24" Bulb 14	85° to 145°F	70° to 130°F	
15		90° to 150°F	
16	110° to 170°F		
16	16 no longer available. Substitute either 15 or 17		
1" x 20" Bulb 17	140° to 200°F	120° to 180°F	Not applicable
18	170° to 230°F	150° to 210°F	
19	200° to 250°F	185° to 245°F	
20	230° to 290°F	220° to 280°F	
21	270° to 330°F	225° to 315°F	

#11 Accessories

Wells

Bulb Size	Chrome-Plated Copper		Stainless Steel	
	Part No.	Price	Part No.	Price
1" x 9"	709 193	\$ 159.00	808 478	\$471.00
1" x 20"	709 075	247.00	808 475	\$586.00

Stem Lubricator (not recommended for steam packing)

Part No.	Price
590184A	\$74.00

Note: Thermal systems are made to order (MTO) and are not returnable or subject to credit.

A **WATTS** Brand

593 –

Valves

- High Performance 2-way **SS**
- Economy 2-way **SD**
- Mixing **WM**
- High Capacity
Balanced 2-way **DB**
- Precision Low Flow **VE**

Size Order Code

- 1/2" (VE only) **A50-D50**
- 1/2" (others)* **050**
- 3/4" **075**
- 1" **100**
- 1 1/4" **125**
- 1 1/2" **150**
- 2" **200**

End Connections

- Screwed **S**

Valve Trim

- Stainless (DB, SS, VE) **S**
- Bronze w/Ep (DB, SD, WM) **B**
- Bronze w/ Teflon (WM) **T**

Action

- Fail Open (Air-to-Close) **X**
- Fail Closed (Air-to-Open) **C**
- Mix **M**

Packing

- Teflon V-Ring **S**
- EP V-Ring **W**

**ACCESSORIES
SELECT CODE**
(refer to next page)

**ACTUATOR
SELECT CODE**
(refer to next page)

*Not available with WM & SD type body.

Note: These products are made to order (MTO) and are not returnable or subject to credit.

A WATTS Brand

Valve Body Prices

SS

Size Code	Body Style/Valve Trim	Price
050	Screwed-NPT, 17-4 SS	\$ 1,116.00
075	Screwed-NPT, 17-4 SS	\$ 1,158.00
100	Screwed-NPT, 17-4 SS	\$ 1,244.00

Size Code	Body Style/Valve Trim	Price
125	Screwed-NPT, 17-4 SS	\$ 1,671.00
150	Screwed-NPT, 17-4 SS	\$ 1,850.00
200	Screwed-NPT, 17-4 SS	\$ 2,800.00

SD

Size Code	Body Style/Valve Trim	Price
075	Screwed-NPT, Bronze	\$ 733.00
100	Screwed-NPT, Bronze	\$ 863.00
125	Screwed-NPT, Bronze	\$ 1,052.00

Size Code	Body Style/Valve Trim	Price
150	Screwed-NPT, Bronze	\$ 1,183.00
200	Screwed-NPT, Bronze	\$ 1,553.00

WM

Size Code	Body Style/Valve Trim	Price
075	Screwed-NPT, Comp. Disc	\$ 656.00
075	Screwed-NPT, Teflon	\$ 656.00
100	Screwed-NPT, Comp. Disc	\$ 896.00
100	Screwed-NPT, Teflon	\$ 896.00
125	Screwed-NPT, Comp. Disc	\$ 1,085.00

Size Code	Body Style/Valve Trim	Price
125	Screwed-NPT, Teflon	\$ 1,085.00
150	Screwed-NPT, Comp. Disc	\$ 1,223.00
150	Screwed-NPT, Teflon	\$ 1,223.00
200	Screwed-NPT, Comp. Disc	\$ 1,612.00
200	Screwed-NPT, Teflon	\$ 1,612.00

DB

Size Code	Body Style/Valve Trim	Price
100	Screwed-NPT, Bronze	\$ 1,462.00
100	Screwed-NPT, 316 SS	\$ 1,925.00
125	Screwed-NPT, Bronze	\$ 1,631.00
125	Screwed-NPT, 316 SS	\$ 2,451.00

Size Code	Body Style/Valve Trim	Price
150	Screwed-NPT, Bronze	\$ 1,967.00
150	Screwed-NPT, 316 SS	\$ 2,557.00
200	Screwed-NPT, Bronze	\$ 2,938.00
200	Screwed-NPT, 316 SS	\$ 4,206.00

VE

Size Code	Body Style/Valve Trim	Price
A-D50	Screwed-NPT, 300/400 SS	\$ 974.00

Actuator Select Code

CODE	PNEUMATIC DIAPHRAGM ACTUATORS	PRICE
46	46 Sq. In. 1"Max Valve Stroke w/Standard Springs adjustable start w/6-12 lb. Fixed Span	\$ 770.00
4X	46 Sq. In. 1"Max Valve Stroke w/Extended Springs (Requires Positioner), adjustable start w/22 lb. Span	\$ 1,056.00
4C	46 Sq. In. 1"Max Valve Stroke Extreme Cycle Springs adjustable start w/6-12 lb. Fixed Span	\$ 1,056.00

Accessories Select Code

CODE	DESCRIPTION	PRICE
	Bellofram 1000 I/P'S	
IS	3-15 psi	\$ 1,829.00
TS	1-17 psi	\$ 1,829.00
US	3-27 psi	\$ 1,829.00
	CONTROL/AIR TYPE 900X I/P	
ES	0-30 psi	\$ 2,356.00
	UTILITY POSITIONER AND I/P	
BS	4-20 mA	\$ 3,054.00
	UTILITY POSITIONER	
PS	3-15 psi	\$ 1,562.00
RS	3-9 psi	\$ 1,562.00
SS	9-15 ps	\$ 1,562.00
	NO ACCESSORIES	
OS	No Accessories	N/C

Note: These products are made to order (MTO) and are not returnable or subject to credit.

A WATTS Brand

596 –

Valves

Mixing **MI**

Size

2 1/2" **250**
 3" **300**
 4" **400**
 5" **500**
 6" **600**

End Connections

125# Flanges **F**

Valve Trim

Bronze **B**

Action

Mixing **M**

Packing

Teflon **T**

**ACCESSORIES
SELECT CODE**

**ACTUATOR
SELECT CODE**

Actuator Compatibility

2-1/2", 3", 4"	46" and 100" Diaphragm
5", 6"	100" Diaphragm

Valve Body Prices

MI

Size Code	Body Style/Valve Trim	Price
250	125 lb. Flanges, Bronze	\$ 2,691.00
300	125 lb. Flanges, Bronze	\$ 3,202.00
400	125 lb. Flanges, Bronze	\$ 3,447.00
500	125 lb. Flanges, Bronze	\$ 6,608.00
600	125 lb. Flanges, Bronze	\$ 7,651.00

Actuator Select Code

CODE	PNEUMATIC DIAPHRAGM ACTUATORS	PRICE
46*	46 Sq. In. 1"Max. Valve Stroke Stainless Steel Springs adjustable start w/6-12 lb. Fixed Span	\$770.00
4X*	46 Sq. In. 1"Max. Valve Stroke w/Extended Stainless Steel Springs (Requires Positioner), adjustable start w/22 lb. Span	\$1,056.00
1M	100 Sq. In; 5-10 psi Spring Range, (Mixing Valves)	\$2,568.00

***Not Available with 5" or 6" valve**

Accessories Select Code

CODE	DESCRIPTION	PRICE
	Bellofram 1000 I/P'S	
IS	3-15 psi	\$ 1,829.00
TS	1-17 psi	\$ 1,829.00
US	3-27 psi	\$ 1,829.00
	CONTROL/AIR TYPE 900X I/P	
ES	0-30 psi	\$ 2,356.00
	UTILITY POSITIONER AND I/P	
BS	4-20 mA	\$3,054.00
	UTILITY POSITIONER	
PS	3-15 psi	\$ 1,562.00
RS	3-9 psi	\$ 1,562.00
SS	9-15 ps	\$ 1,562.00
	NO ACCESSORIES	
OS	No Accessories	N/C

Note: These products are made to order (MTO) and are not returnable or subject to credit.

A WATTS Brand

597 –

Valves

2-Way **SI**

Size

2 1/2" **250**
 3" **300**
 4" **400**
 5" **500**
 6" **600**

End Connections

125# Flanges **F**

Valve Trim

Bronze **B**

Action

Fail Open (Air-to-Close) **X**
 Fail Closed (Air-to-Open) **C**

Packing

Teflon **T**

ACCESSORIES
SELECT CODE

ACTUATOR
SELECT CODE

Valve Body Prices

SI

Size Code	Body Style/Valve Trim	Price
250	125 lb. Flanges, Bronze	\$ 2,691.00
300	125 lb. Flanges, Bronze	\$ 3,202.00
400	125 lb. Flanges, Bronze	\$ 3,447.00
500	125 lb. Flanges, Bronze	\$ 6,608.00
600	125 lb. Flanges, Bronze	\$ 7,651.00

Actuator Select Code

CODE	PNEUMATIC DIAPHRAGM ACTUATORS
4C	46 Sq. In., 1" Max Valve Stroke Extreme Cycle Springs, adjustable start w/6-12 lb. fixed span. \$770.00
1U (for 6" valve only)	100 Sq. In; 8-13 psi Spring Range, (Normally Closed Valves) \$2,568.00
1L (for 6" valve only)	100 Sq. In; 3-8 psi Spring Range, (Normally Open Valves) \$2,568.00

Accessories Select Code

CODE	DESCRIPTION	PRICE
	Bellofram 1000 I/P'S	
IS	3-15 psi	\$ 1,829.00
TS	1-17 psi	\$ 1,829.00
US	3-27 psi	\$ 1,829.00
	CONTROL/AIR TYPE 900X I/P	
ES	0-30 psi	\$ 2,356.00
	UTILITY POSITIONER AND I/P	
BS	4-20 mA	\$3,054.00
	UTILITY POSITIONER	
PS	3-15 psi	\$ 1,562.00
RS	3-9 psi	\$ 1,562.00
SS	9-15 ps	\$ 1,562.00
	NO ACCESSORIES	
OS	No Accessories	N/C

Note: These products are made to order (MTO) and are not returnable or subject to credit.

A WATTS Brand

Unmounted Valve Accessories

PRODUCT NUMBER	DESCRIPTION	PRICE
UTILITY GRADE PNEUMATIC POSITIONERS		
1473000D	1/8" - 3/16" Stroke Full Range	\$ 1,814.00
1473000C	1/4" - 3/8" Stroke Full Range	\$ 1,814.00
1473000	1/2" - 3/4" Stroke Full Range	\$ 1,814.00
1473000A	1" - 1 1/2" Stroke Full Range	\$ 1,814.00
1473000C	1/8" - 3/16" Stroke Split Range	\$ 1,814.00
1473000	1/4" - 3/8" Stroke Split Range	\$ 1,814.00
1473000A	1/2" - 1" Stroke Split Range	\$ 1,814.00
1420373	Positioner Output Pressure Gauge	\$ 86.00
POSITIONER MTG. KIT		
147301E	46" Act., Fail Open, 1/4" Stem	NLA
147302E	46" Act., Fail Close, 1/4" Stem	NLA
147301G	46" Act., 1/2" Stem	\$ 129.00
147301H	100" Act., 1/2" Stem	\$ 129.00

PRODUCT NUMBER	DESCRIPTION	PRICE
UTILITY MTG. KIT I/P & POSITIONER		
593002E	46" Act., Fail Open, 1/4" Stem	\$ 367.00
593003E	46" Act., Fail Close, 1/4" Stem	\$ 367.00
593002G	46" Act., 1/2" Stem	\$ 367.00
593002H	100" Act., 1/2" Stem	\$ 367.00
UTILITY I/P MTG. KIT		
512118E	46" Act., Fail Open, (Dir.Act.)	\$ 257.00
512119E	46" Act., Fail Close (Rev.Act.)	\$ 257.00
590184A	Stem Lubricator (Type "W" Packing Only)	\$ 74.00
512118H	100" Act.	\$ 257.00
BELLOFRAM 1000 I/P'S		
512 015	3-15 I/P Transducer	\$ 1,313.00
512 117	1-17 I/P Transducer	\$ 1,313.00
512 027	3-27 I/P Transducer	\$ 1,313.00
CONTROL/AIR TYPE 900X I/P		
100 127	0-30 psi with Mounting Kit, 46" Act.	\$ 2,152.00
100127H	0-30 psi with Mounting Kit, 100" Act.	\$ 2,040.00

Accritem® Temperature Controller

Adjustable setpoint, 50° to 350°F.
Complete with pressure gauges and fittings.

Rigid Copper Bulb (1/2" NPT Pipe Fitting)

Model	Action	Order Code	Weight (in lbs.)	List Price
Air Operated	Direct	7441213	3	\$ 636.00
	Reverse	7441214	3	\$ 1,004.00
Water Operated	Direct	7441217	4	\$ 1,342.00
	Reverse	7441218	4	\$ 1,342.00

Rigid Stainless Bulb (1/2" NPT Pipe Fitting)

Model	Action	Order Code	Weight (in lbs.)	List Price
Air Operated	Direct	7441270	4	\$ 1,402.00
	Reverse	7441271	4	\$ 1,402.00

Accritem® Accessories

Description	Order Code	Weight (in lbs.)	List Price
Accessory Kit for Air or Gas	744 107	2	\$ 227.00
Accessory Kit for Water	744 180	1	\$ 398.00
Union Fitting—Brass	744 106	1	\$ 125.00
Socket Well—Copper	744 111	1	NLA
Socket Well—Stainless Steel	744 082	1	\$ 619.00
Valve and Seat Repair Kit	744 168	1	\$ 79.00

Accritem® II Temperature Controller

Adjustable setpoint, dual scale: 0° to 300°F and 20° to 150°C.
Complete with pressure gauges and fittings.

Remote Copper Bulb (3/8" x 4" bulb, 4 ft. capillary) Includes 3/8" NPT Compression Fitting

Model	Action	Order Code	Weight (in lbs.)	List Price
Air Operated	Direct	7441256	2	\$ 1,117.00
	Reverse	7441258	2	\$ 1,117.00

Remote Stainless Bulb (3/8" x 4" Bulb, 10 ft. capillary) Includes 3/8" NPT Compression Fitting

Model	Action	Order Code	Weight (in lbs.)	List Price
Air Operated	Direct	7441272	2	\$ 1,559.00
	Reverse	7441273	2	\$ 1,559.00

Accritem® II Accessories

Description	Order Code	Weight (in lbs.)	List Price
Accessory Kit for Air or Gas	744 107	2.0	\$ 227.00
Socket Well—Copper	184 119	0.4	NLA
Socket Well—Stainless	184 118	0.4	NLA

A WATTS Brand

Part No.	Description	List Price
030-884	FIL HD ST STL SCREW	7.50
030-885	FIL HD ST STL SCREW	7.50
030-889	SCREW	7.50
032-071	FL HD BR SCREW	NLA
032-072	FIL HEAD BR SCREW	NLA
034-407	SCREW 1/4-28 X 1/4" LONG	8.30
043819A	1/2"STAND OFF	100.60
043821A	PIPE STRAP 3/4"	NLA
046007K	LOCKWASHER	NLA
047-013	QUAD-RING	8.30
047-020	O-RING	8.30
047-029	O-RING	8.30
047-031	RING	8.30
047-035	O-RING 2 X 2 1/4 X 1/8	8.30
047-047	O-RING #241	6.30
047-108	O-RING,#019	7.50
047-125	QUAD RING,,ORDER 440 22	8.30
047-128	O-RING # 034	NLA
047-129	O-RING	8.30
047-130	O-RING #037	8.30
047-131	O RING	8.30
047-132	O RING	8.30
080-026	TRIM SCREW - 1 piece	8.30
080-042	SCREW 8.32 X 3-1/2 LG	16.70
082005R	WASHER 1"OD x.594ID x 1/	8.30
084-008	'O'RING, 2 x 2-3/16 x 3/	8.30
084-010	O-RING	6.30
084-014	O-RING 5/8 X 3/4 X 1/16	8.30
084-015	O-RING 15/16 X 3/4 X 3/3	8.30
084-016	O-RING	8.30
084-031	O RING #17	8.30
084-032	O RING #128	11.10
084-033	O-RING #112	8.30
087-126	SILICONE	6.30
105-060	Cartridge Kit TempTAP	227.90
105-064	105-064	56.40
131274A	KEY FOR CABINET SUPPLY F	30.20
141-000	1/2" CHECKSTOP KIT	86.10
141-305	ADJ FLOW CONTL 410+420 H	49.00
141-313	FLANGE	NLA
141-320	ELBOW	100.80
141381F	141381F SCREWS	30.90
141382A	SHOWERHEAD KIT	NLA
141-620	HANDLE KIT, DIVERTER VAL	38.80
141-621	STEM KIT	71.10
141-622	FACE PLATE ASS'Y FOR DIV	116.10
141-651	CHECK VALVE	14.20
141-808	END CAP ALSON'S GLIDE	50.00
141-809	SLIDE, GLIDE RAIL HAND S	74.70

Part No.	Description	List Price
141-839	CARTRIDGE ASSEMBLY	479.40
141901N	SHOWER HEAD WALL	232.20
1420373	PRESSURE GAUGE	86.00
200-046	1 1/2 PLUG BRASS	15.00
220-050	E700 HANDLE KIT, METAL	77.90
220-051	E700 TRIM PLATE KIT	124.20
220-052	E700 HANDLE KIT ABS	68.40
220-053	E700 TRIM PLATE KIT ABS	109.00
220-054	E700 SLEEVE KIT	55.10
220-060	E700 CARTRIDGE KIT	152.20
225238G	ADJG SCR	NLA
225294A	LOCK RING	39.70
230-079	STEM	35.70
230-083	GASKET, .75 X .50 X .035	8.30
230-104	SCREEN, 1 & 1 1/4 NPT	18.10
230-116	SCREEN	20.80
230-131	1/2 IN TRIPLE DUTY G	45.20
230-132	TRIPLE DUTY POPPET K	102.60
230-134	3/4 TRI DUTY SCREEN	102.60
230-135	3/4 IN TRIP DUTY POP	102.60
230-136	1 1/4 TRI DUTY SCRIN	154.40
230-137	1 1/4 TRI DUTY POPPE	154.40
230-269	3/4 STEM PLAIN	73.00
230-281	CHECKSTOP COMPLETE	180.50
390-808	LOW TEMP ACT KIT	92.60
390-809	ACTUATOR STD TEMP	162.10
390-810	LOW TEMP ACTUATOR KIT	148.40
390-811	CHECKSTOP REBUILD KIT	150.50
390-812	PLUNGER KIT MM435	54.80
390-813	O-RING KIT MM435	5.80
390-814	ACTUATOR STD TEMP NLA	432.00
390-815	ACTUATOR LOW TEMP	432.00
390-826	FUNNEL KIT MM431/432	151.20
390-827	MM433/434 FUNNEL KIT	169.80
390-828	FUNNEL KIT MM435	196.20
400-023	SHUT OFF DISC	8.30
401-165	TEMPERATURE STOP	8.40
401-176	STEM REPL KIT 400 HYDROG	51.90
401-202	BAL. CHAMBER EXTRACTOR	26.30
401-218	MAX TEMP STOP	8.30
401-231	SELECTOR DIAL	52.50
401-267	SLEEVE	14.70
401-278	ADJUSTABLE STOP	8.30
410-138	SHUT OFF DISC SPG	8.30
410-146	BONNET GASKET	15.80
410-182	SER 410 HYDRO GASKET REP	42.50
410-233	STEM EXTENSION KIT	73.50
410-248	BAL CHAMBR KIT 440 FOTOP	195.00
410-365	HANDLE SCREW KIT 10/bag	27.90

A WATTS Brand

Part No.	Description	List Price	Part No.	Description	List Price
410-366	410 'O'RING KIT FOR 410+B93	21.50	444-126	SCREWDRIVER FOR ESP SHOW	11.00
410-367	RETAINER KIT FOR 410 HYD	78.80	444-135	COCK HOLE COVER KIT	12.40
410-374	DIAL INSERT STD	36.50	444-183	SHOWER SOLENOID REPAIR	327.20
410-375	THROTTLING STEM ASSY	50.00	444-260	SWITCH, PIEZO CERAMIC FO	211.70
410-377	SUPPORT RING	25.20	444-416	SWITCH PIEZO ELECTRIC	318.00
410-378	STEM REPLACEMENT KIT,MDL	72.30	450-272	SCREW 8-32 X 2 1/4 LG. S	17.20
410-389	DIAL ASSY KIT FOR SERIES	232.60	450-277	GASKET, 3/32 SHOWER HEAD	8.30
410-396	412/414 BONNET KIT	112.90	473-039	473 DIGITAL TEMP DISPLAY	267.00
410-413	DIAL W/O SLOT	48.30	473-042	KIT, POWDER COATED SCREW	13.50
410-417	RETAINER	15.50	480-270	E480 MOTOR REPAIR KIT	39.50
410-427	FLOW RESTRICTOR GUIDE	8.30	590-233	UNION TAIL PIECE, 2"	123.80
410-440	BALANCE CHAMBER ASSEMBLY	82.80	590-690	DISC HOLDER/STEM EXT. AS	241.10
410-442	GREY DIAL INSERT (410)	35.00	590-763	PACKING GLAND ASSY	27.10
410-445	DIAL ASSEMBLY, STD. GRAY	147.30	590808B	STEM EXTENSION	10.50
410-447	KNOB HANDLE KIT, GRAY 41	72.80	591-927	STEAM SERVICE PKG KIT	93.80
410-448	410 LEVER HANDLE ASSEMBL	72.80	591-928	STEAM SERVICE PACKING KI	105.50
410-565	TRI HANDLE REPLACEMENT K	134.40	591-957	1/4" EP FLOWRITE PACKING	24.30
410-570	SEAL KIT, OVERSIZED 410	35.30	594-220	WATER SERVICE PACKING KI	51.80
420-102	420 SOFT PART KIT	44.60	594-221	WATER SERVICE PACKING KI	74.90
420-114	3/4 IN VALVE	359.10	595-499	NAMEPLATE	5.60
420-182	DIAL ASSEM KIT	232.60	672-626	460 ACTUATOR DIAPHRAGM	119.20
420-212	MAX TEMP STOP KIT	47.40	672-636	ACTUATOR STEM, DA, 1/4"	99.70
420-242	HANDLE KIT	144.00	672636A	RA STEM	95.60
420-243	420 LEVER HANDLE KIT	116.30	672-724	YOKE (PAINTED & MACHINED	120.50
420-308	DIAL INSERT 420 MODELS 8	36.30	705-005	TANK FITTING, 1" BRASS	33.50
420-330	NAMEPLATE/BASEPLATE FOR	75.20	800-005	BONNET	16.40
420-335	DIAL ASSEMBLY MODEL 8	147.30	800015H	SLEEVE	34.60
420-336	MDL 8 SERIES 420 LEVER H	147.30	800-020	GASKET	8.30
420-337	ACRYLIC KNOB KIT, MODEL	147.30	800-030	REPAIR KIT-SOFT COMPONEN	47.40
420-452	CARTRIDGE, MODELS 5-10	83.70	800032A	STEM & BONNET REPLACEMEN	77.60
420-453	WAX MOTOR KIT (420)	109.50	800-036	LEVER HANDLE KIT	62.60
420-454	BONNET KIT, MODELS 1-10	349.10	800-040	ROUND FACEPLATE KIT	152.20
420-495	410 LEVER HANDLE KIT	82.40	800-064	FUNNEL O-RING	8.30
420-616	420 UPGRADE KIT	316.40	800-098	BILTMORE REPAIR KIT, LEV	286.10
427-017	CARTRIDGE ASSEMBLY	126.00	800-099	CONVERSION REBUILD KIT	286.10
427-019	KIT, BONNET ASSY	125.30	800-163	800 SERIES REBUILD KIT	175.00
427-200	427 WAX KIT 65-115	512.00	800-164	SCREW, 8-32 X 5/8 LG	8.30
427-202	427 WAX KIT (75-175F)	627.80	800-200	HANDLE KIT, ACRYLIC 800	112.90
427-250	427 WAX MOTOR KIT	217.20	900-012	STEM	20.30
427-251	427 WAX MOTOR KIT	217.20	900-015	BONNET	8.30
427-252	427 WAX MOTOR KIT	217.20	900020A	900 SS DIAL	82.00
430-016	TEMP ADJ LOCK SCREW KIT	38.50	900-028	GASKET KIT, MODEL 3 SERI	49.10
430-017	TEMP ADJ LOCK SCREW KIT	29.80	900-030	REPAIR KIT, SOFT COMPONE	49.10
430-020	MAX TEMP ADJ SCREW KIT 4	42.70	900-031	BILTMORE INTERNALS KIT	144.40
440-145	ON OFF VALVE REPAIR KIT	67.90	900031A	BILTMORE INTERNALS KIT	118.10
440-154	SHUT OFF MANIFOLD	75.20	900-032	BILTMORE INTERNALS KIT	140.30
440-157	ADAPTOR	13.20	900-035	900 ACRYLIC KNOB KIT	63.40
440-178	THERMOMETER MANIFOLD MO	116.30	900-036	900 LEVER HANDLE KIT	75.20
440181A	FRONT PANEL	NLA	900-040	FACEPLATE KIT,ROUND ESCU	133.50
440-205	ON-OFF VALVE REPLACEMENT	379.00	900-049	CHECKSTOP REPAIR KIT	95.70
440-223	QUAD RING KIT 440 FOTOG	42.70	900-050	CHECK STOP KIT, MODEL 3	95.70

A WATTS Brand

Part No.	Description	List Price
900-070	LEVER HANDLE,ZINC	47.70
900-090	TRIM PLATE,BRIGHT CHROME	20.60
900-091	HANDLE,BRIGHT CHROME	24.80
900-092	INSERT,HANDLE	8.30
900-093	GASKET FOR SLEEVE	8.30
900-094	GASKET,TRIM PLATE	8.30
900-095	NAMEPLATE, GRAPHIC	19.90
900-096	905 PLUG BUTTON	8.30
900-102	FACEPLATE KIT, CHROME	116.30
900-105	HANDLE KIT, CHROME	82.40
900-107	LEVER HANDLE KIT, LESS S	75.20
900-109	STEM EXTENSION KIT	84.70
900-132	SLEEVE	52.40
900-140	PLUG BUTTON (1 EACH)	13.00
900-197	OUTLET SEAL	8.30
900-219	BONNET	8.30
900-231	STEM ASSEMBLY	15.10
900-240	BALANCE CHAMBER KIT	69.60
900-259	BALANCE CHAMBER ASSEMBLY	89.00
900-269	SLEEVE KIT, SMALL	59.00

Part No.	Description	List Price
----------	-------------	------------

A WATTS Brand

Part No.	Description	List Price	Part No.	Description	List Price
----------	-------------	------------	----------	-------------	------------

To locate your nearest Powers representative, please click on our *FIND A REP* locator on PowersControls.ca

Represented by:

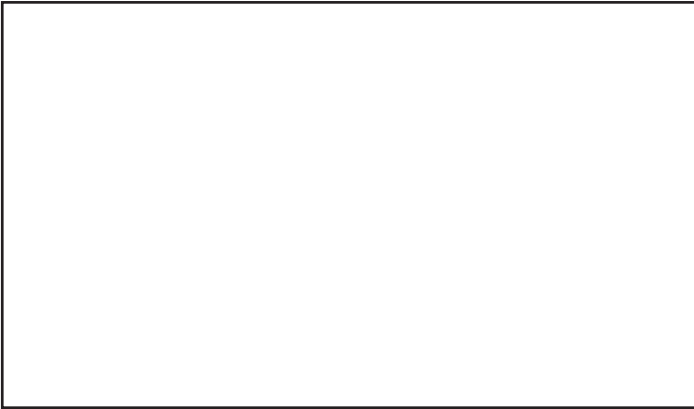

POWERS™

A WATTS Brand

USA: T: (800) 669-5430 • F: (847) 229-0526 • PowersControls.com
Canada: T: (905) 332-4090 • F: (905) 332-7068 • PowersControls.ca
Latin America: T: (52) 81-1001-8600 • PowersControls.com