

Now includes our
LEAD FREE*
product offering

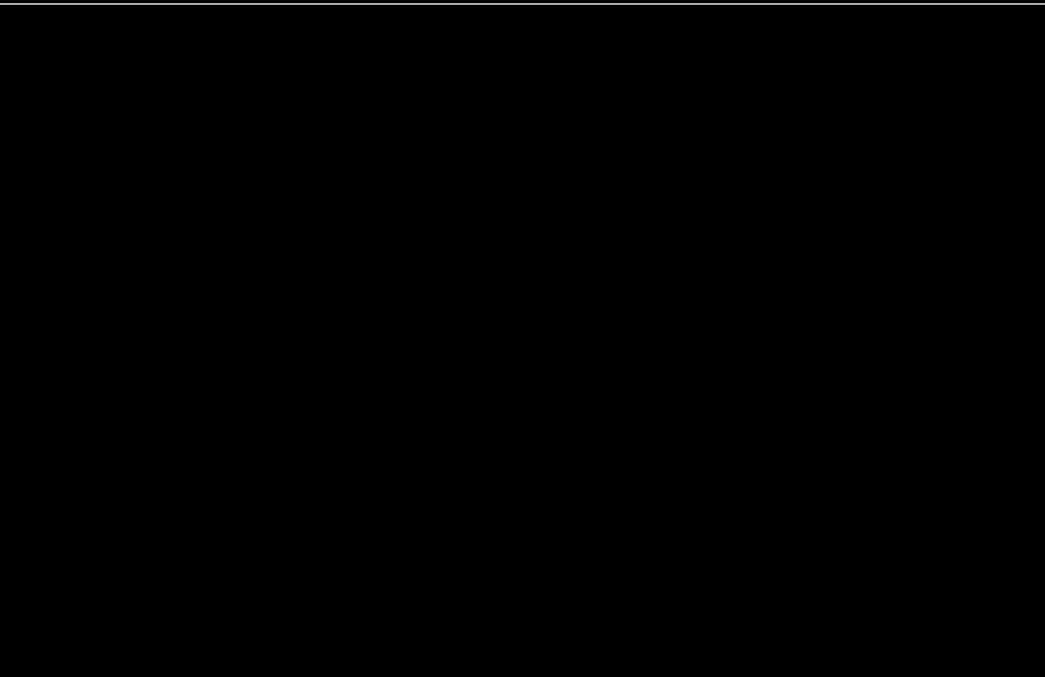

Thermal Expansion Products



watts.com



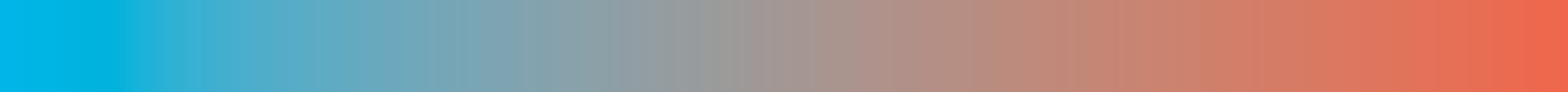















Table of Contents

General Information	2 – 4
Potable Hot Water System	5
 Series PLT Potable water expansion tanks	6
 Series DETA ASME pressurized potable water expansion tanks	7
 Series LFBRV Combination ball valve and relief valve	8
 Series Governor 80M2 Ball cock and thermal expansion relief valve	9
 Series LF530C Calibrated pressure relief valve	10
Nonpotable Hot Water System	11
 Series 276H300/IWTG Water pressure test gauges	12
 Series SCV Service check valves	13
 Series ETX-ASF Combination packages	14
 Series HPX Boiler trim-out packages	14
 Boiler Header Modules Pro Hydronic packages	15
 Series ETX, ETSX pressurized expansion tanks for heating and cooling systems	16
 Series ETA ASME pressurized nonpotable water expansion tanks	18
 Series ET-RA ASME pressurized nonpotable water expansion tanks	19

Watts product specifications in U.S. customary units and metric are approximate and are provided for reference only. Watts reserves the right to change or modify product design, construction, specifications, or materials without prior notice and without incurring any obligation to make such changes and modifications on Watts products previously or subsequently sold.



General Information

What is Thermal Expansion?

When water is heated, it expands. For example, water heated from 90°F (32°C) to a thermostat setting of 140°F (60°C) in a 40 gallon hot water heater will expand by almost one-half gallon. This is because when water is heated, its density decreases and its volume expands (see fig. 1). Since water is not compressible, the extra volume created by expansion must go someplace. During no-flow periods in a system, pressure reducing valves, backflow preventers, and other one-way valves are closed, thus eliminating a path for expanded water to flow back to the system supply. Hence, system pressure increases.

figure 1

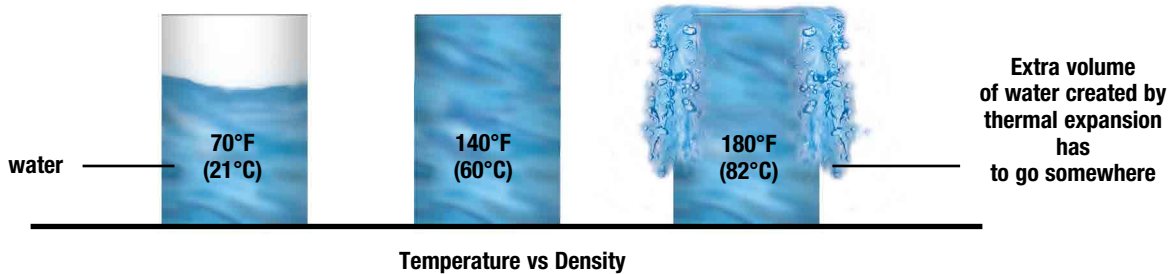

Thermal expansion of water in a closed plumbing system can create a number of annoying and potentially dangerous problems. These include: the build up of unusually high pressure in a system (even when a pressure reducing valve is installed); pressure surges; and the chronic or continuous dripping of a temperature and pressure (T&P) relief valve. In addition, dripping faucets and leaking toilet tank ball cock fill valves are also symptomatic of thermal expansion.

More serious problems can also occur due to thermal expansion. When dangerous pressures are built up in a water heater, internal parts may fail such as the internal flues, fittings or water connections. If a flue way collapses, it can lead to the potential release of toxic gases, such as carbon monoxide into living spaces. Thermal expansion can also lead to a ruptured or distorted hot water heating tank and may void the manufacturer's warranty (see fig.2).

figure 2

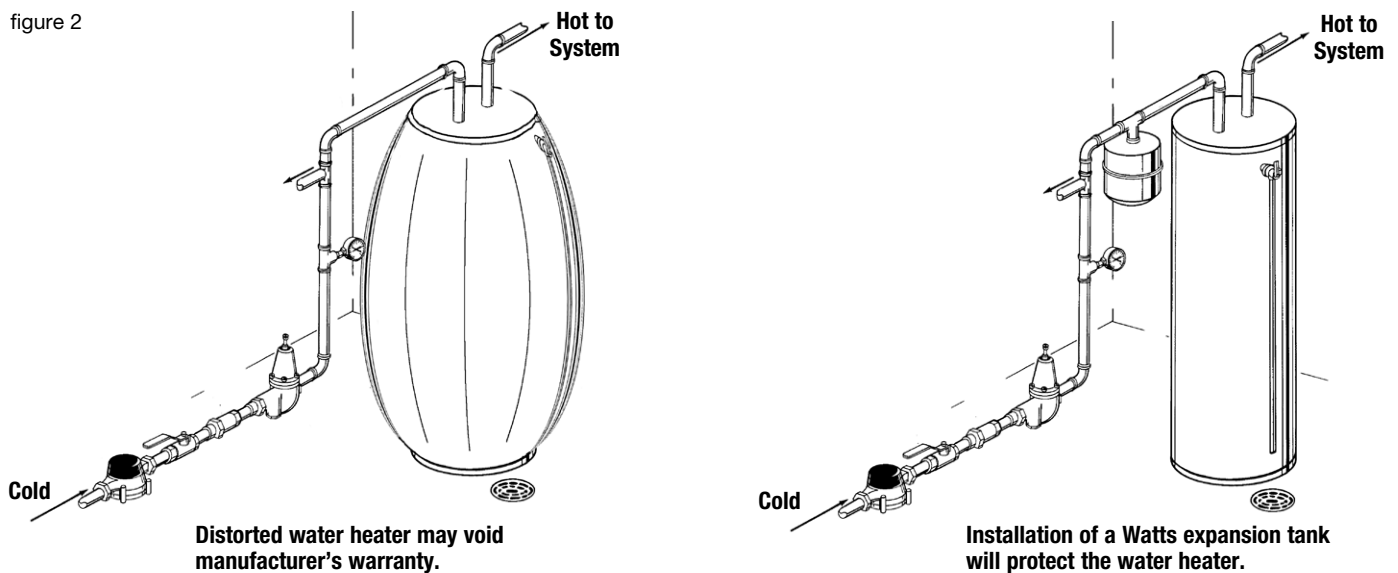

Plumbing codes require you to address this safety problem.

No matter what your thermal expansion problem may be, whether for new construction or for retrofitting or remodeling an existing system, Watts offers cost effective solutions for you as outlined in the following pages of this guide. Should you require more detailed information on these products, please feel free to call your local Watts representative, listed on the back of this guide.

Plumbing Code Requirements

Thermal Expansion Control

Plumbing codes require that thermal expansion control be addressed in plumbing systems. **A temperature and pressure relief valve is not considered a thermal expansion device.** This is because when water is allowed to continuously drip from the T&P relief valve, minerals from the water can build up on the valve, eventually blocking it. This blockage can render the T&P valve useless and potentially lead to hot water heater explosions. The International Plumbing Code (IPC), Uniform Plumbing Code (UPC) and Standard Plumbing Code all require thermal expansion control to be addressed.

Expansion Tank Construction

Section VIII of the ASME Boiler and Pressure Vessel Code states certain requirements that must be met by an expansion tank for it to meet ASME construction specifications. The Watts Series ETA, ET-RA and DETA tanks all meet these ASME requirements.

Potable vs Nonpotable Systems

Potable refers to water in an open domestic hot water heating system. This is water that could potentially be consumed by people and is not recirculated within the system. Nonpotable refers to water in a closed hydronic heating, radiant floor heating, or a chilled water system where the water is recirculated and does not leave the system.

Each of these hot water heating systems have different thermal expansion requirements explained in more depth in the following pages of this guide.

Water Containment vs Water Relief Solutions

Water Containment solutions allow for thermal expansion while containing thermally expanded water in the plumbing system. The Watts full line of thermal expansion tanks are considered water containment devices. These products require no installation of discharge lines or drains.

Water Relief solutions discharge thermally expanded water at a pressure setting that is below the setting of the water heater's temperature and pressure relief valve. Watts offers a variety of water relief solutions that can be installed on the system piping, in a water closet or on an outside faucet. These products must be piped to a suitable drain or discharge location.

Expansion Tanks

How a Diaphragm Expansion Tank Works

When water is heated in a closed system, it expands. Water is not compressible, therefore, the additional water volume created has to go someplace. When an expansion tank is installed, the excess water enters the prepressurized tank (figure 3). As the temperature and pressure reaches its maximum, the diaphragm flexes against an air cushion (air is compressible) to allow for increased water expansion (figure 4). When the system is opened again or the water cools, the water leaves the tank and returns to the system.

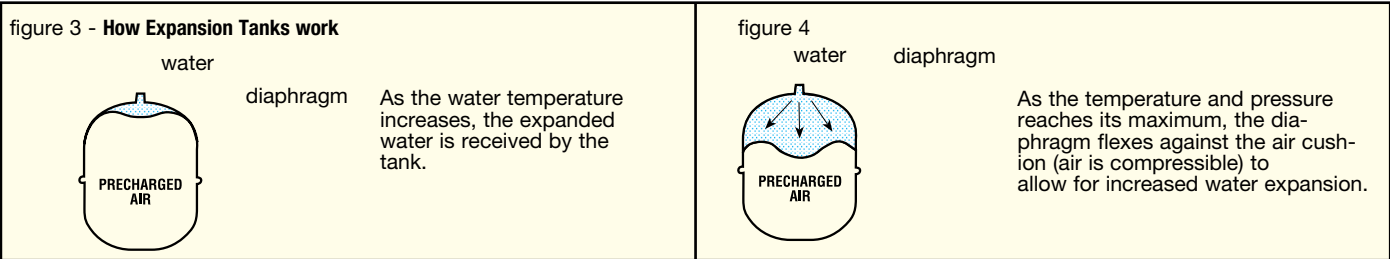

Note: Expansion tanks are always located on the cold water piping to the water heater or heating system.

Selecting an Expansion Tank

To properly select the correct expansion tank for a system, you can either use the selection guide tables which are placed near each tank series throughout this product guide (see figure 5) or use a formula to determine the tank volume and acceptance volume requirements. When using a formula, it is necessary to know the water heater capacity, the water supply pressure, the starting and ending water temperatures and the maximum pressure setting of the relief valve.

figure 5

Note: Expansion based on 50°F (10°C) temperature rise.

SUPPLY PRESSURE	WATER HEATER						
	Gallons (Liters)						
psi bar	20 (76)	30 (114)	40 (152)	50 (190)	80 (304)	100 (380)	120 (456)
40 2.7							
50 3							
55 3.7							
60 4							
70 4.8							
80 5.5							
90 6							
100 6.9							
110 7.5							
120 8.2							

Tank A
 Tank B
 Tank C
 Multiple tanks required

To select the correct expansion tank, using the selection guides in this product guide, choose the supply pressure (for pressures between those shown, use next highest supply pressure), read across the chart to the correct tank as indicated by the water heater capacity. For capacities between those shown, use next highest capacity.

To accommodate the thermal expansion required for higher temperature and/or higher pressure systems, multiple tanks may be used. Please contact your local authorized Watts representative for assistance in sizing expansion tanks for specific applications requiring multiple tanks.

Other Potable Water Thermal Expansion Solutions



Series LFBRV

Watts offers several other options for pressure relief besides expansion tanks. These products do not prevent against loss of water, like an expansion tank, but they do limit high pressure and prevent the annoying problems associated with thermal expansion. These products include the: Governor 80M2 combination toilet tank ball cock fill valve and thermal expansion relief valve; the LF530C calibrated pressure relief valve; the LFBRV combination ball valve and relief valve and the H32 hose connection pressure relief valve. These products are described in more detail in the following pages of this product guide.

Control Thermal Expansion in Hot Water Supply Systems

Thermal expansion of heated water may occur wherever potable water is heated in a closed system (when the potable water is isolated from the public water supply by a one-way valve, such as a pressure reducing valve, backflow preventer or check valve). Watts potable water expansion tanks are designed to absorb the increased volume of water created by thermal expansion and to maintain a balanced pressure throughout the potable water supply system. They are used to prevent plumbing system and/or water heater damage and unnecessary relief valve discharge caused by excessive pressure from thermal expansion.

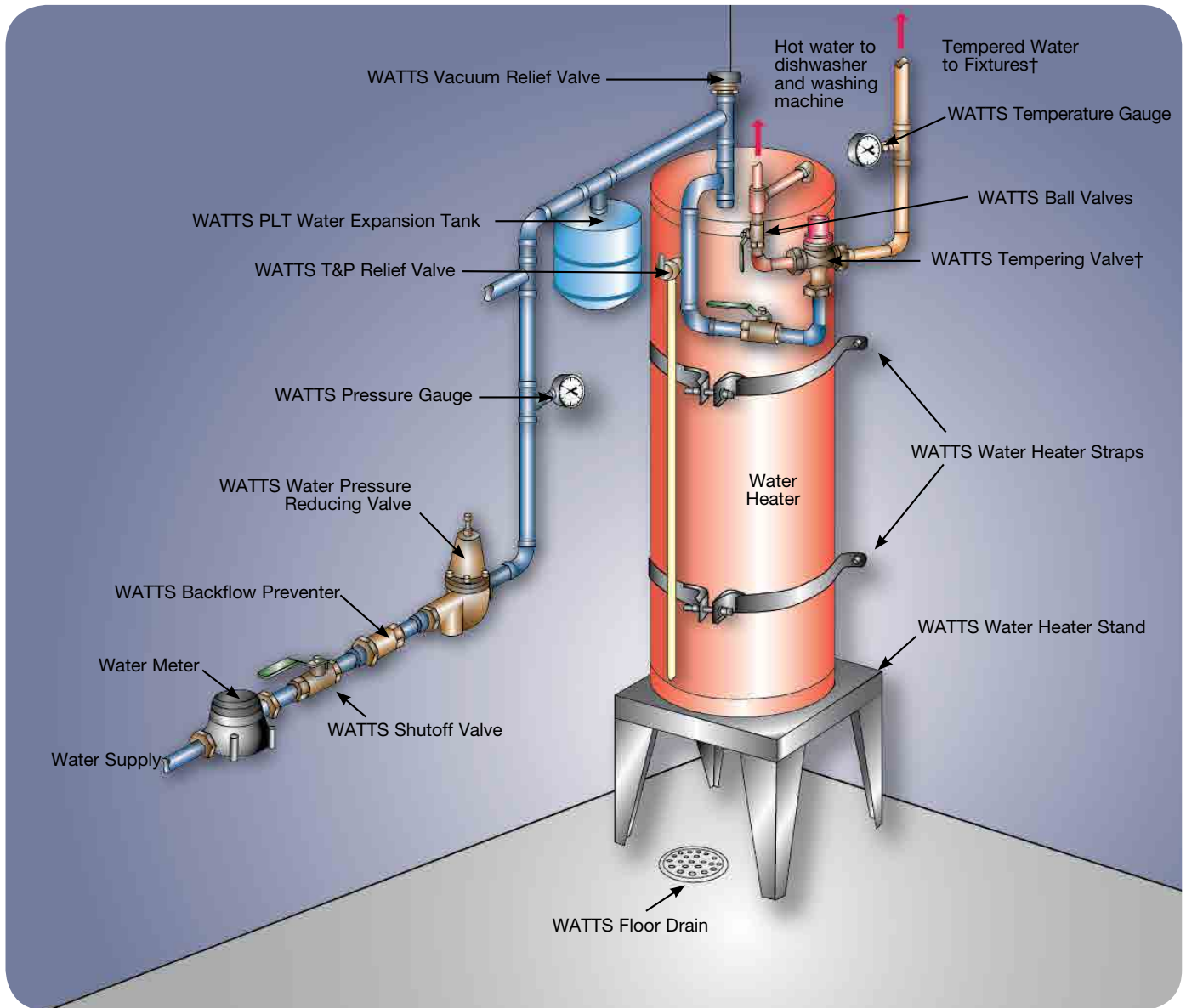

†ASSE 1016 – Listed valves such as the Watts LFL111, LFMMV or LFUSG should be used at point-of-delivery.

Series PLT

Potable Water Expansion Tanks

Models PLT-5, PLT-12, PLT-20, and PLT-35

Series PLT Potable Water Expansion Tanks are designed to absorb thermal expansion and to maintain balanced pressure throughout the potable water supply system.

Heated water expands, and in a domestic hot water system, the system may be closed when isolated from the public water supply by a one-way valve, pressure reducing valve, backflow preventer, check valve, etc. Provisions must be made for this expansion.

Series PLT expansion tanks absorb the increased volume of water created when the hot water storage tank is heated and keeps the system pressure below the relief setting of the T&P relief valve. It is a prepressurized steel tank with an expansion membrane that prevents contact of the water with the air in the tank. This prevents loss of air to the water and ensures long and trouble-free life for the system. These tanks may be used with all types of Direct Fired Hot Water Heaters (gas, oil or electric) and hot water storage tanks.



Standards

Models PLT-5, PLT-12 and PLT-20 are Listed by IAPMO. Certified to ANSI/NSF 61

Model PLT-35 Certified to ANSI/NSF 61



(73°F/23°C)

Features

- Rugged flexible butyl diaphragm
- Field adjustable pre-charge
- In-line and free standing models
- Can be used with most standard hot water heaters and storage tanks

Models

PLT-5 has 3/4" male connection, tank volume 2.1 gal.
 PLT-12 has 3/4" male connection, tank volume 4.5 gal.
 PLT-20 has 3/4" male connection, tank volume 8.5 gal.
 PLT-35 has 1" female connection, tank volume 14.0 gal.

Specifications

The potable water expansion tank shall be of drawn steel construction and include a rigid polypropylene reservoir liner. It shall have a butyl diaphragm separating the air chamber from the water containing chamber. Inlet connector shall be stainless steel lined. Materials of manufacture for the liner and diaphragm shall be FDA approved. The potable water expansion tank shall be a Watts Series PLT.

For additional information, request literature ES-PLT.

SUPPLY PRESSURE		WATER HEATER						
		Gallons (Liters)						
psi	bar	20 (76)	30 (114)	40 (152)	50 (190)	80 (304)	100 (380)	120 (456)
40	2.7							
50	3							
55	3.7							
60	4							
70	4.8							
80	5.5							
90	6							
100	6.9							
110	7.5							
120	8.2							

- PLT-5
- PLT-12
- PLT-20
- PLT-35
- Multiple tanks required - consult authorized Watts agent

This table is based upon a relief valve setting of 150psi (10.3 bar), a maximum of 40°F (4°C) temperature rise, and a 20psi (138 kPa) precharge.*

*It is recommended that tanks be precharged to supply pressure (up to 80psi (5.5 bar)). Equalizing precharge pressure to supply pressure increases the application range over those shown in the table.

Model	Connection Size (DN)		Max. Pressure		Max. Temp.		Tank Volume		Tank Acceptance		Air Precharge		Diameter		Length		Weight	
	in.	mm	psi	bar	°F	°C	gal.	liters	gal.	liters	psi	kPa	in.	mm	in.	mm	lbs.	kgs.
PLT-5	3/4 M	20	150	10.3	200	93	2.1	8	1.26	4.8	20	138	8	203	11	279	5.5	2.5
PLT-12	3/4 M	20	150	10.3	200	93	4.5	17	2.8	10.6	20	138	10.5	267	13½	343	10	4.5
PLT-20	3/4 M	20	150	10.3	200	93	8.5	32	3.2	12.1	20	138	12.5	318	19.2	488	15	6.8
PLT-35	3/4 M	20	150	10.3	200	93	14.0	53	5.6	21.2	20	138	16.0	406	21.7	551	32	14.5

Series DETA

ASME Pressurized Expansion Tanks for Potable Hot Water

Models DETA 5 – DETA 210

Series DETA tanks are ASME fixed bladder type pre-charged expansion tanks for commercial and industrial fresh potable hot water applications. They are designed to accept the expanded volume of hot water keeping the system pressure below the relief valve setting. The water is contained in a butyl bladder.

Maximum Design Pressure: DETA 5 – DETA 210:
 150psi (10.3 bar)
 Precharged to 40psi (276 kPa)
 Maximum Design Temperature: 240°F (115°C)



Features

- ASME Section VIII construction
- Fixed butyl bladder (FDA approved)
- Stainless steel system connection
- Precharged to 40psi (276 kPa) (field adjustable)
- Shell: carbon steel
- System connection: stainless steel
- Bladder: butyl (FDA approved)
- Primer coated exterior

Specifications

Furnish and install as shown on plans a Watts Model DETA ___ gallon ___" diameter x ___" (high) precharged steel thermal expansion tank with a fixed butyl bladder. The tank shall have a top NPT stainless steel system connection and a .302" – 32" (7.6 – 812.8mm) charging valve connection (standard tire valve) to facilitate the on-site charging of the tank to meet system requirements. The tank must be constructed in accordance with Section VIII of the ASME Boiler and Pressure Vessel Code.

For additional information, request literature ES-DETA.

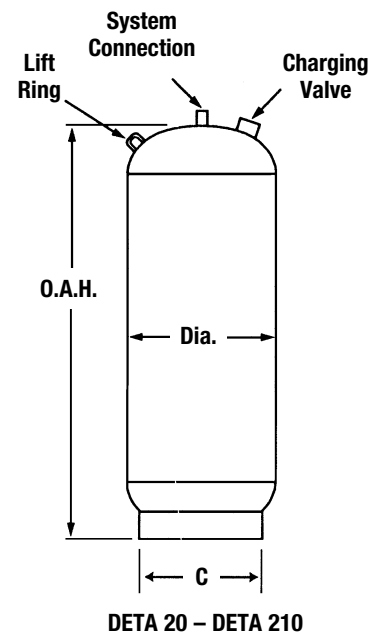
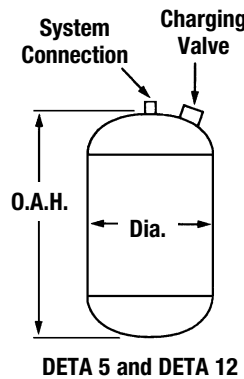

Model	System Connection (DN)		Tank Volume		Acceptance Volume		Max. Operating Pressure		Dimensions (approx.)						Weight	
	in.	mm	Gallons	Liters	Gallons	Liters	psig	bar	Dia.		Height		C		lbs.	kgs.
DETA 5	3/4	20	3.5	13	2.1	8	150	10.3	10	254	14	356	–	–	22	10
DETA 12	3/4	20	5	19	3.1	11.7	150	10.3	12	305	14	356	–	–	28	13
DETA 20	3/4	20	8	30	3.1	11.7	150	10.3	12	305	20	508	10	254	34	15
DETA 30	1	25	15	57	10.5	40	150	10.3	16	406	33	838	12	305	64	29
DETA 42	1	25	22	84	15.5	59	150	10.3	16	406	32	813	14	356	88	40
DETA 60	1	25	26	99	15.5	59	150	10.3	16	406	34	864	14	356	93	42
DETA 80	1	25	35	133	15.5	59	150	10.3	16	406	45	1143	14	356	109	49
DETA 100	1	25	45	171	21	80	150	10.3	20	508	38	965	18	457	148	67
DETA 125	1	25	60	228	21	80	150	10.3	20	508	49	1245	18	457	175	79
DETA 160	1 1/2	40	70	266	52.5	199.5	150	10.3	24	610	46	1676	22	559	259	117
DETA 180	1 1/2	40	80	304	52.5	199.5	150	10.3	24	610	49	1168	22	559	268	122
DETA 210	1 1/2	40	90	342	52.5	199.5	150	10.3	24	610	52	1321	22	559	283	128

Lift ring on models DETA 42 – DETA 210.

Series LFBRV

Combination Ball Valve and Relief Valves

LEAD FREE* Series LFBRV, Combination Ball Valve and Relief Valve is an easy to install two-in-one device. Designed to be used as water heater shutoff valves to provide both a means to shut off the water supply to the water heater and to provide protection against excess water pressure caused by thermal expansion. The Series LFBRV features Lead Free* construction to comply with Lead Free* installation requirements.

These valves use a Lead Free* copper silicon alloy body full port valve design** which includes PTFE seats and a blow out proof stem design. The relief valve section includes a Viton® ball and stainless steel spring. It is provided with a compression or PEX end fitting to provide a secure method of connecting a discharge line.

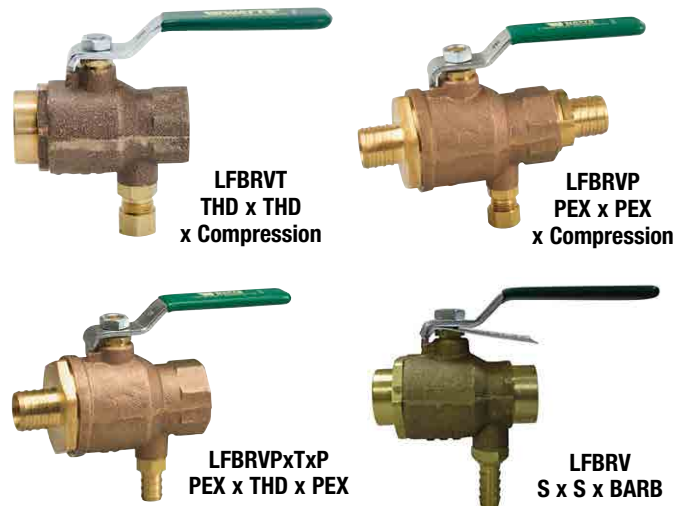

Features

- Easy Installation - Installs in any position
- Low profile design
- Full port ball valve with virgin PTFE seats
- Blowout proof stem
- Secure drain tube connection available with PEX, Barb or compression fitting models

Specifications

Valve shall include built-in relief protection from water pressure in excess of 75, 80, 100, or 125psi. Each valve shall be full port construction**, Lead Free* copper silicon alloy body, blowout proof 316 stainless steel stem, virgin PTFE seats, PTFE stem packing and stem thrust bearing, Viton® relief ball and 302 stainless steel relief spring. Lead Free* combination ball valve and relief valve shall be constructed using Lead Free* materials. Lead Free* valves shall comply with state codes and standards, where applicable, requiring reduced lead content. Valves shall include brass compression nut and ferrule or PEX end connection for a drain line. Valve shall be IAPMO listed. Valve shall be a Watts Series LFBRV.

** PEX end connections reduce full port to reduced port dimensions.

For additional information, request literature ES-LFBRV.

Available Models

Inlet	Outlet	Relief Outlet
Sweat	Sweat	PEX
Sweat	Sweat	Compression
Thread	Thread	Compression
PEX	PEX	Compression
PEX	PEX	PEX



Typical Installation

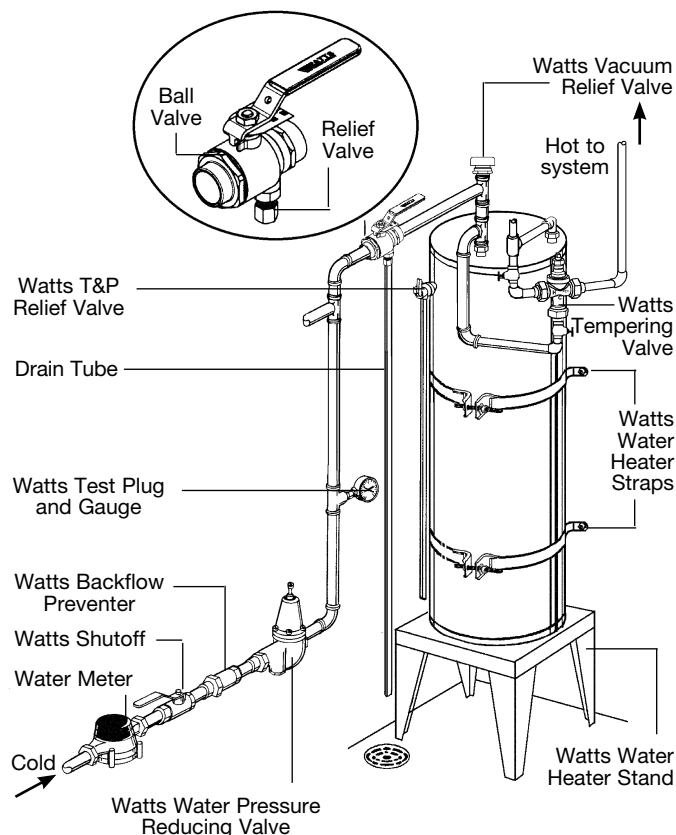

Temperature – Pressure Rating

Maximum Temperature: 100°F (32°C)
 Maximum Pressure: Valve body rated to 400psi (28 bar)

Standards

Listed by IAPMO

*The wetted surface of this product contacted by consumable water contains less than 0.25% of lead by weight.

Model Governor™80M2

Toilet Fill Valve and Thermal Expansion Relief Valve

The Governor™80M2 is a feature rich universal toilet tank fill valve designed to protect plumbing systems and to conserve water. As a fill valve, it is able to detect a leaking toilet flapper and to prevent the tank from continuously refilling until a repair is made. The override feature enables the toilet to continue to be used until the flapper can be replaced.

The Governor™80M2 is also a thermal expansion pressure relief valve limiting supply line pressure and protecting plumbing from the damaging effects of pressure surges due to thermal expansion. The Governor™80M2's water conservation feature helps to eliminate the "overflow" condition present with traditional toilet fill valves. The adjustable flow control on the primer tube allows the tank to fill to the appropriate level without overflowing. The Governor™80M2 also acts as an anti-siphon backflow preventer keeping tank water from backing up into the potable water supply.

Features

- Leak sensor alerts you to a leaking flapper
- Surge relief limits the supply line pressure to 80psi (552 kPa)
- Simple installation – No tools required
- Adjustable water flow control conserves water
- Manual float lock allows toilet to be used until repair can be made
- Adjustable primer flow control
- Prevents backflow of toilet tank water into potable water supply
- Adjustable to fit most standard toilet tanks

Specifications

The Watts Governor 80-M1 is tested and certified under ASSE Standard 1002 and meets IAPMO, and CSA requirements for anti-siphon ball cocks. All materials in contact with water are FDA approved under DVR-21-177-2600. The thermal expansion relief valve is standardly set at 80psi (5.5 bar) to meet existing codes and is non-adjustable. Standard lengths are: 10", 11½" or 12½" (254, 292 or 317mm).

Temperature — Pressure Rating

Maximum Working Pressure: 80psi (552 kPa)

Temperature Range: 33°F – 110°F (0.5°C – 43.3°C)

Materials

Body: ABS and Acetal Plastic

Gasket: Black rubber

Standards



1002-2008



Governor™80M2

U.S. Pat. No. 8,132,273

For additional information, request literature ES-GOV80M2.

Series LF530C

Calibrated Pressure Relief Valves

LEAD FREE* Series LF530C Calibrated Pressure Relief Valves are spring operated Lead Free* valves designed for use only as protection from the build up of excessive pressure in systems containing water, oil or air. Series LF530C valves incorporate a calibrated adjustment feature for setting the valve to the relief pressure required. These valves are ideally suited for bypass thermal expansion relief.

Features

- Calibrated adjustment feature for setting valve to relief pressure required
- Adjustable range 50 – 175psi (3.4 – 12.1 bar)
- All Lead Free* cast copper silicon alloy body
- All stainless steel spring
- Buna-N disc on machined body seat
- Inlet (bottom), male NPT threaded
- Outlet (side), female NPT threaded



Model LF530C

Temperature – Pressure Rating

Maximum Temperature: 180°F (82°C)

Spring Ranges

1/2" or 3/4" (15 or 20mm): 50 – 175psi (3.4 – 12.1 bar)

3/4" (20mm): 100 – 300psi (6.9 – 20.7 bar)

Application Note: The Watts Series LF530C are not ASME approved safety relief valves and should not be used in system application with this requirement.

Typical Installation

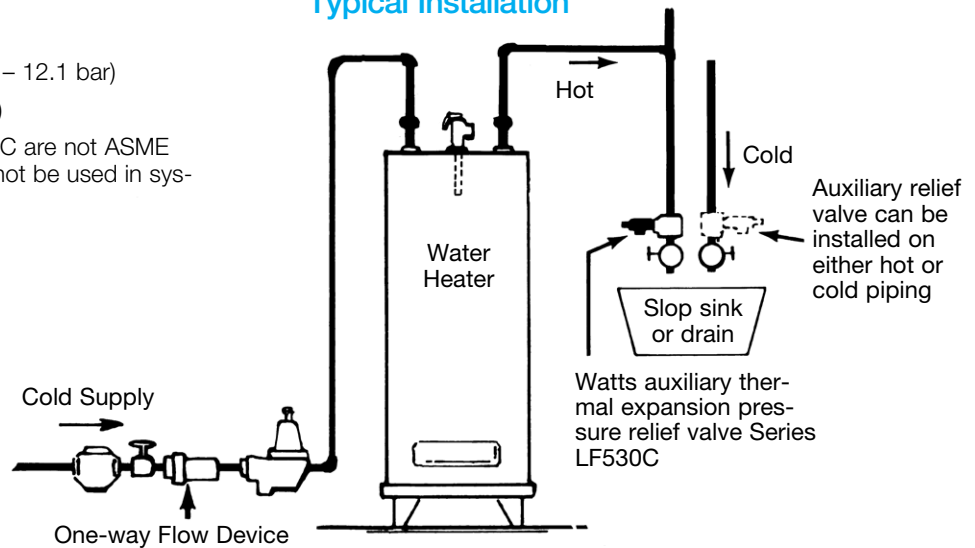

For additional information, request literature ES-LF530C.

*The wetted surface of this product contacted by consumable water contains less than 0.25% of lead by weight.

Control Thermal Expansion

in Hot Water Heating Systems

Thermal expansion of heated water may occur wherever water is heated in a closed system (when the boiler water is isolated from the public water supply by a one-way valve, such as a feed water pressure reducing valve, backflow preventer, check valve, etc.). Watts Nonpotable water expansion tanks are designed to absorb the increased volume of water caused by thermal expansion and maintain a balanced pressure throughout the hot water heating system. They are used to prevent system damage and unnecessary relief valve discharge caused by excessive pressure from thermal expansion.

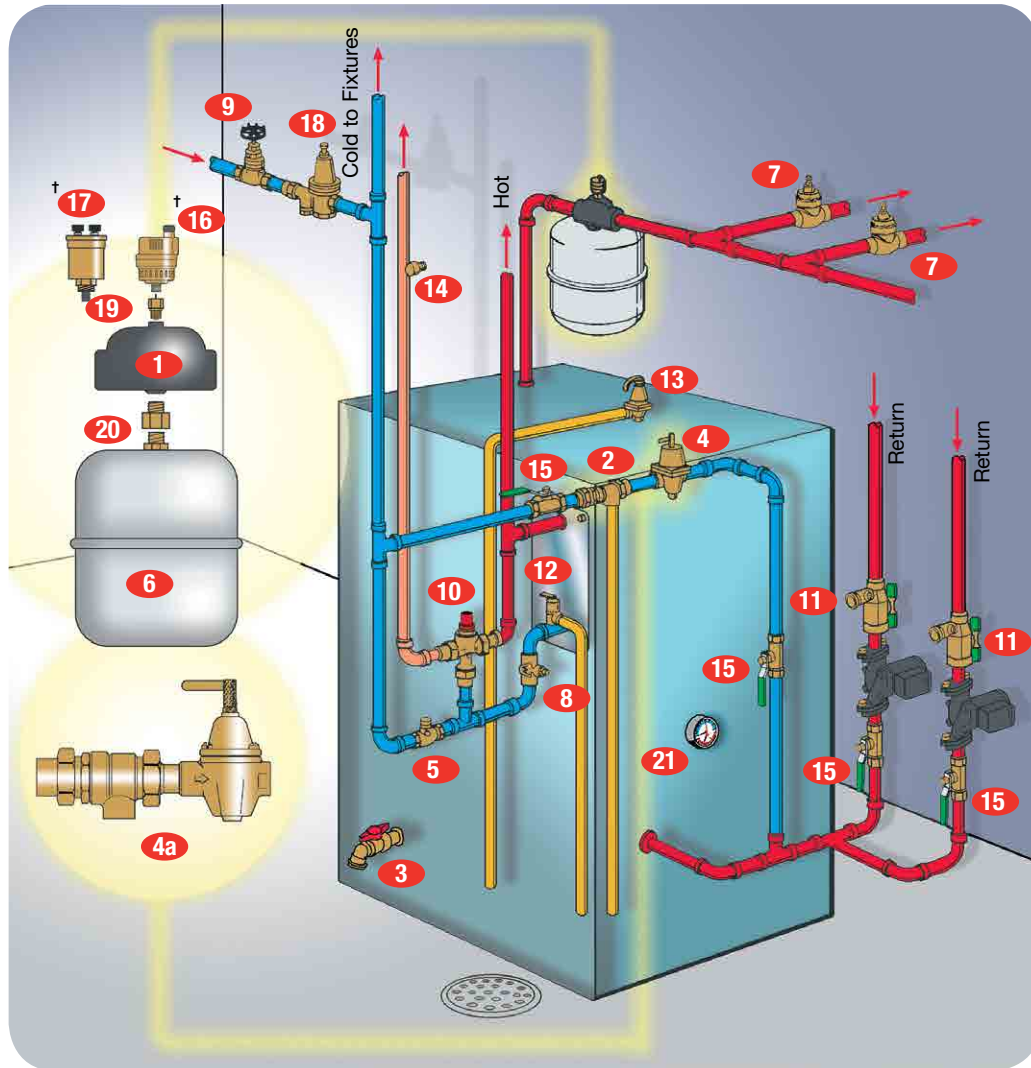

- | | |
|---|---|
| 1 Air Separator | 11 Purge Valves |
| 2 Backflow Preventer | 12 Pressure Relief Valves |
| 3 Boiler Drain Valve | 13 Hot Water Boiler Safety Relief Valve |
| 4 Boiler Fill Valves | 14 T&P Test Plug |
| 4a Combination Fill Valve and Backflow Preventer | 15 Ball Valve |
| 5 Bronze Check Valve | † 16 Float Vent Valve |
| 6 Expansion Tank | † 17 Automatic Float Vent Valve |
| 7 Flow Checks | 18 Water Pressure Reducing Valve |
| 8 Flow Control Valve | 19 1/8" (3mm) or 1/4" (8mm) Service Check Valves |
| 9 Gate or Globe Valves | 20 1/2" (15mm) Service Check Valve |
| 10 Mixing Valves | 21 Combination Temperature & Pressure Gauge |

† Choose one item #16 or #17

Series 276H300, IWTG

Water Pressure Test Gauge

Ideal to accurately determine system pressure in a building. The 3/4" (20mm) hose connection easily attaches to a hose bibb or the drain connection on a water heater. A red indicator hand holds at the highest reading registered. When left on overnight, it will register the highest pressure in the system during that period.

(A)

3/4" (20mm) H.T. Hose Connection which easily attaches to an outside hose bibb or to the drain connection on a water heater.

(B)

A Red indicator hand that "HOLDS" at the highest reading registered, to record shock pressure or when left on overnight will register the highest surge pressure which occurred during that period.

(C)

Features a large (2 1/2" (65mm)) face for easy reading.

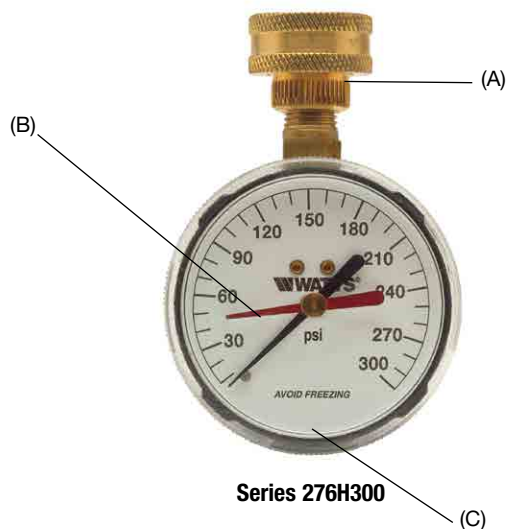

Model	Size (DN)		Range	
	<i>in.</i>	<i>mm</i>	<i>psi</i>	<i>bar</i>
276H300	3/4	20	0 – 300	0 – 21
IWTG	3/4	20	0 – 200	0 – 14

Series SCV

Service Check Valves

Series SCV service check valves facilitate the servicing of components in systems under pressure. They install between the system and the component.

As the component is threaded into the Service Check Valve, the spring loaded valve opens to system pressure.

As the component is removed, the valve closes, maintaining system integrity while the component is being inspected. This prevents having to drain the entire system each time a component is serviced.



Available in sizes 1/8" and 1/2" inches.
Max. Temperature: 240°F (115°C), Max. Pressure: 150psi (10 bar)

⚠ WARNING

This device is not to be used on safety relief valves or other safety or flow sensitive components.

NOTICE

System pressure must be reduced prior to removing system component.

Model.	Size (DN)	
	in.	mm
SCV	1/8	3.2
SCV	1/2	12.7

Typical Installation

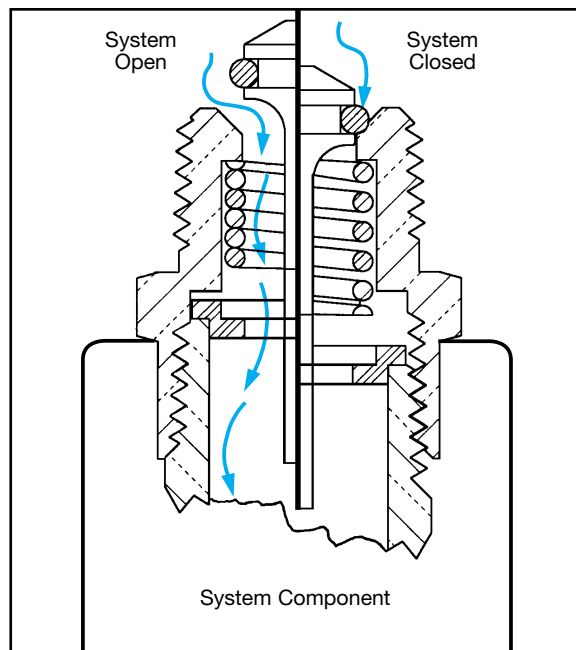

Series ETX-ASF

Combination Packages

Series ETX-ASF hydronic boiler combination packages make it easier to buy system components by including an ETX expansion tank, AS air separator, and FV4-M1 float vent valve all in one package and for a lower cost than buying each of the components separately.

Model	Air Separator		Float Vent FV-4M1		Expansion Tank		
	1" (25mm)	1 1/4" (32mm)	1/8" (3mm)	1/8" (3mm)	ETX-15	ETX-30	ETX-60
Combination Packages							
ETX-15-ASF	X		X		X		
ETX-15-ASF		X	X		X		
ETX-30-ASF	X		X			X	
ETX-30-ASF		X	X			X	
ETX-60-ASF	X		X				X
ETX-60-ASF		X	X				X



Series HPX

Boiler Trim-Out Packages

Series HPX boiler trim-out packages contain all the essential trim-out components of a quality boiler installation in a single easy to carry package.

Package Includes:

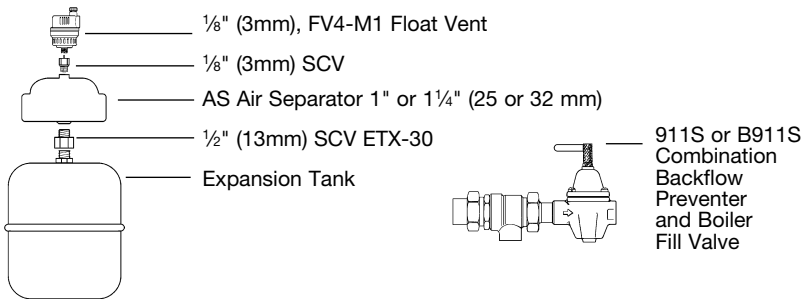

Package Selection Chart

Model	Air Separator		Service Check Valve		Float Vent		Fill Valve B1156	Fill Valve/ Backflow Preventer		Flow Check 2000S-M5 1" (25mm)	Expansion Tank	
	1" (25mm)	1 1/4" (32mm)	1/8" (3mm)	1/2" (15mm)	FV-4M1 1/8" (3mm)	DuoVent 1/8" (3mm)		911S	B911S		ETX-15	ETX-30
Boiler Trim-out Packages												
HPX-C	X		X	X	X			X				X
HPX-D		X	X	X	X			X				X
HPX-15 BC	X		X	X		X			X		X	

Boiler Header Modules

Complete Packages to Purge, Quiet, Fill, and Service Your Hydronic System

Out of the box, our Boiler Header Module delivers components that make following the industry recommended near-boiler piping virtually foolproof. Boiler industry recommendations (system purge station, followed by an air separator, followed by a service fitting) ensure the contractor correctly pipes a hydronic installation — quickly, easily, and neatly in a compact job space.

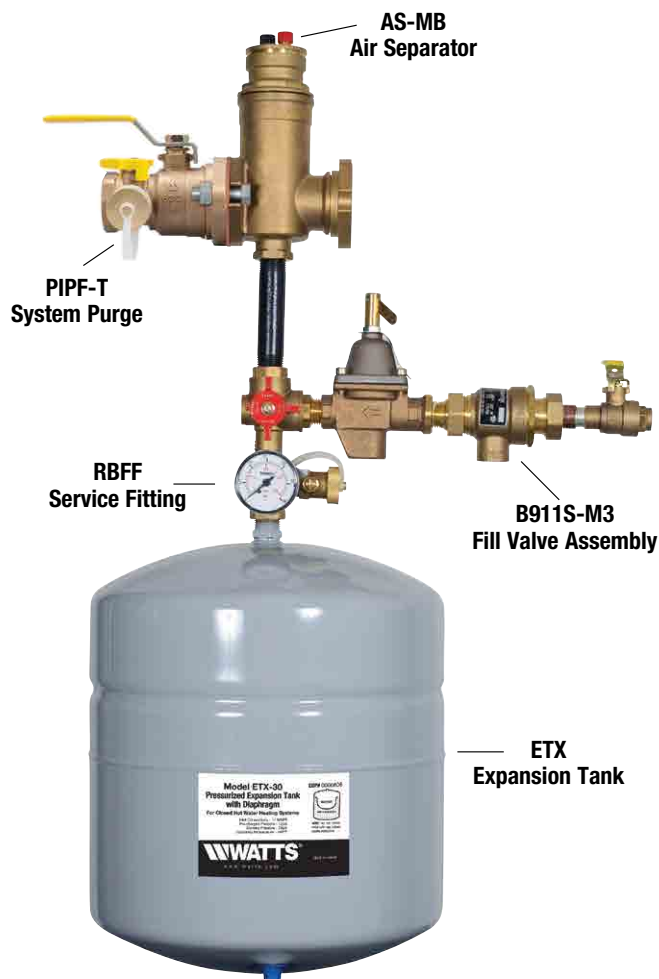

Boiler Header Module Pro Hydronic Packages

Model	Ordering Code	Includes
HP-30PRO-P100	0235098	HP-BHM-100, ETX-30 (0066606), B911S-M3 (0386462)
HP-30PRO-P125	0235099	HP-BHM-125, ETX-30 (0066606), B911S-M3 (0386462)



Pro Hydronic Packages with NPT AS-MB & RBFF

Model	Ordering Code	Includes
HP-30PRO-100	0235096	AS-MB-100 (0858547), RBFF (0386466), ETX-30 (0066606), B911S-M3 (0386462)
HP-30PRO-125	0235097	AS-MB-125 (0858548), RBFF (0386466), ETX-30 (0066606), B911S-M3 (0386462)
HP-30PRO-100S	0235101	AS-MB-S-100 (0858551), RBFF (0386466), ETX-30 (0066606), B911S-M3 (0386462)
HP-30PRO-125S	0235102	AS-MB-S-125 (0858552), RBFF (0386466), ETX-30 (0066606), B911S-M3 (0386462)



Series ETX, ETSX

Pressurized Expansion Tanks for Heating and Cooling Systems*

Series ETX and ETSX Pressurized Expansion Tanks for Heating and Cooling Systems are designed to absorb the increased volume of water created when water is heated. These tanks maintain system pressure below the relief setting of the relief valve. The Series ETX and ETSX's prepressurized steel tank features a durable expansion membrane that prevents contact of the water with the air in the tank. This rugged diaphragm minimizes loss of the air change and ensures long and trouble-free life for the system.



Series ETX

Features

- Precharged at 12psi (83 kPa)
- Rugged flexible butyl diaphragm
- In-line and free standing models
- Compatible with glycol in systems
- Steel construction

Models

- ETX Mounts to supply piping
ETSX Free standing

Specifications

Furnish and install as shown on plans a Watts Model ETX/ETSX ____ gallon ____ " diameter x ____ " (high) pre-charged steel expansion tank with a fixed butyl bladder. The tank shall have an NPT system connection and a .302"-32 charging valve connection (standard tire valve) to facilitate the on-site charging of the tank to meet system requirements. The tank shall be factory precharged to 12psi. The tank shall be a Watts Series ETX or ETSX.

Maximum Working Temperature: 220°F (115°C)

Maximum Working Pressure:

ETX-15, ETX-30, ETX-60: 75psi (517 kPa)

ETX-90 and ETSX Series: 100psi (6.9 bar)

Precharge (field adjustable): 12psi (83 kPa)

*Not for use on potable water systems.



Series ETSX

Quick Sizing Chart

Boiler Output Net BTU/H	Finned Tube Baseboard	Convectors or Unit Heaters	Cast Iron Radiators	Cast Iron Baseboard
Suggested Selection				
20,000	ETX-15	ETX-15	ETX-15	ETX-15
30,000	ETX-15	ETX-15	ETX-15	ETX-15
40,000	ETX-15	ETX-30	ETX-30	ETX-30
50,000	ETX-15	ETX-30	ETX-30	ETX-30
60,000	ETX-30	ETX-30	ETX-60	ETX-60
70,000	ETX-30	ETX-30	ETX-60	ETX-60
80,000	ETX-30	ETX-30	ETX-60	ETX-60
90,000	ETX-30	ETX-30	ETX-60	ETX-60
100,000	ETX-30	ETX-60	ETX-60	ETX-60
125,000	ETX-30	ETX-60	ETX-60	ETX-90
150,000	ETX-30	ETX-60	ETX-90	ETX-90
175,000	ETX-60	ETX-60	ETX-90	ETX-90
200,000	ETX-60	ETX-60	ETX-90	ETX-90
250,000	ETSX-30	ETSX-30	ETSX-40	ETSX-30
300,000	ETSX-30	ETSX-40	ETSX-40	ETSX-30
350,000	ETSX-30	ETSX-40	ETSX-60	ETSX-30
400,000	ETSX-30	ETSX-60	ETSX-90	ETSX-40
500,000	ETSX-40	ETSX-60	ETSX-90	ETSX-40
600,000	ETSX-40	ETSX-90	ETSX-90	ETSX-60
700,000	ETSX-60	ETSX-90	ETSX-90	ETSX-60
800,000	ETSX-60	ETSX-110	ETSX-110	ETSX-90
900,000	ETSX-60	ETSX-110	ETSX-110	ETSX-90
1,000,000	ETSX-90	ETSX-110	ETSX-110	ETSX-90
1,200,000	ETSX-90	ETSX-110	ETSX-160	ETSX-90
1,400,000	ETSX-110	ETSX-160	ETSX-160	ETSX-110
1,500,000	ETSX-110	ETSX-160	ETSX-110 (2)	ETSX-110

Note: These recommendations are based on the average water volume of typical closed systems.

Fill pressure 12psi, relief valve set pressure of 30psi and system temperature of 200°F.

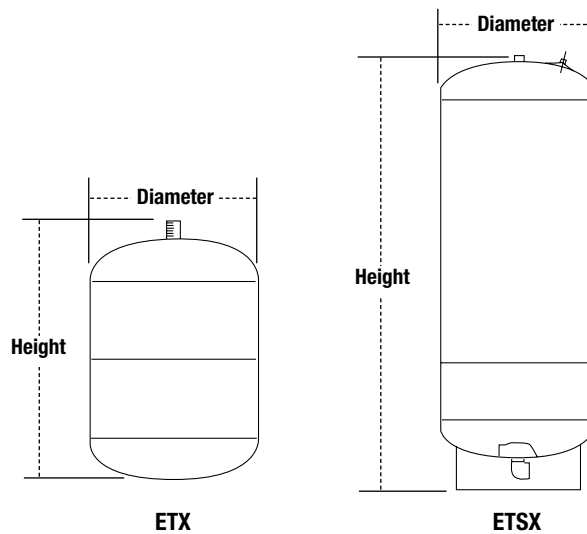

Model	Connection Size (DN)		Tank Volume		Accept. Volume		Diameter		Height		Weight	
	gallons	liters	gallons	liters	gallons	liters	in.	mm	in.	mm	lbs.	kgs.
ETX-15	½" MNPT	15	2.1	7.9	1.0	3.8	8	203	12½	318	0.5	0.23
ETX-30	½" MNPT	15	4.5	17.1	2.5	9.5	11	279	14	356	10.0	4.54
ETX-60	½" MNPT	15	6.0	22.8	3.0	11.4	11¾	290	17¾	437	11.5	5.22
ETX-90	¾" MNPT	20	15.0	57.0	6.0	22.8	16	406	20¾	528	28.0	12.70
ETSX-30	1" FNPT	25	15.0	57.0	6.0	22.8	16	406	21¼	551	32.0	14.51
ETSX-40	1" FNPT	25	20.0	76.0	8.0	30.4	16	406	28¾	732	39.0	17.69
ETSX-60	1" FNPT	25	33.0	125.4	13.3	50.5	16	406	42¾	1087	57.0	28.85
ETSX-90	1¼" FNPT	32	44.0	167.2	17.7	67.3	21	533	36¾	919	72.0	32.66
ETSX-110	1¼" FNPT	32	62.0	235.6	24.9	94.6	21	533	47⅞	1217	112.0	50.80
ETSX-160	1¼" FNPT	32	81.0	307.8	32.6	123.9	21	533	62	1575	123.0	55.79

Series ETA

ASME Pressurized Expansion Tanks for Heating and Cooling Systems

Models ETA 15 – ETA 240

Series ETA tanks are ASME fixed bladder type pre-charged expansion tanks. They are designed to absorb the expansion forces and control the pressure in heating and cooling systems. The water is contained in the heavy duty bladder preventing tank corrosion and waterlogging problems.

Features

- ASME Section VIII Construction
- Heavy duty butyl bladder
- Precharged to 12psi (83 kPa) (Field Adjustable)
- Shell: Carbon steel
- Bladder: Heavy duty butyl
- Primer coated exterior

Specifications

Furnish and install as shown on plans a Watts Model ETA ____ gallon ____ " diameter x ____ " (high) precharged steel expansion tank with a fixed butyl bladder. The tank shall have a top NPT system connection and a .302" – 32" (7.6 – 812.8mm) charging valve connection (standard tire valve) to facilitate the on-site charging of the tank to meet system requirements. The tank must be constructed in accordance with Section VIII of the ASME Boiler and Pressure Vessel Code.

Maximum Design Pressure:
 ETA 15 – ETA 60: 150psi (10.3 bar)
 ETA 80 – ETA 240: 125psi (8.6 bar)
 Precharged to 12psi (83 kPa)
 Maximum Design Temperature: 240°F (115°C)

For additional information, request literature ES-ETA.

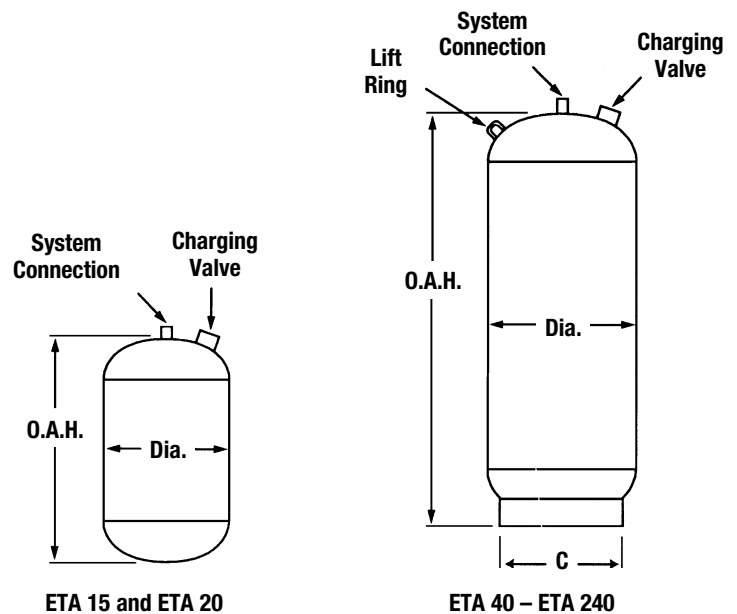

Model	System Connection Size (DN)		Tank Volume		Acceptance Volume		Max. Operating Pressure		Dimensions (approx.)						Weight	
	in.	mm	Gals.	Liters	Gals.	Liters	psig	bar	Dia.		Height		C		lbs.	kgs.
ETA 15	3/4	20	7.8	29.6	2.5	9.5	150	10.3	12	305	19	483	–	–	42	19
ETA 20	3/4	20	10.9	41.4	2.5	9.5	150	10.3	12	305	26	660	–	–	52	24
ETA 40	1	25	25	95	10	38	150	10.3	16	406	33	838	12	305	84	38
ETA 60	1	25	35	133	10	38	150	10.3	16	406	45	1143	12	305	97	44
ETA 80	1	25	45	171	21	80	125	8.6	20	508	38	968	18	457	148	67
ETA 100	1	25	60	228	21	80	125	8.6	20	508	49	1245	18	457	175	79
ETA 120	1 1/2	40	70	266	48	182.4	125	8.6	24	610	46	1168	22	559	259	117
ETA 144	1 1/2	40	80	304	48	182.4	125	8.6	24	610	49	1245	22	559	268	122
ETA 180	1 1/2	40	90	342	48	182.4	125	8.6	24	610	52	1321	22	559	283	128
ETA 200	1 1/2	40	115	437	48	182.4	125	8.6	24	610	66	1676	22	559	325	147
ETA 240	1 1/2	40	140	532	52	197.6	125	8.6	24	610	78	1981	22	559	362	164

Series ET-RA

ASME Pressurized Expansion Tanks for Heating and Cooling Systems

Models ET-RA 35 – ET-RA 2000

Series ET-RA tanks are ASME removable bladder type precharged expansion tanks. They are designed to absorb the expansion forces and control the pressure in heating and cooling systems. The water is contained in the heavy duty bladder, preventing tank corrosion and waterlogging problems.

Features

- ASME Section VIII Code Construction
- Removable butyl bladder
- Precharged to 12psi (83 kPa) (Field Adjustable)
- Shell: Carbon steel
- Bladder: Heavy duty butyl
- Primer coated exterior

Specifications

Furnish and install as shown on plans a Watts Model ET-RA ___ gallon ___" diameter x ___" (high) precharged steel expansion tank with a heavy duty butyl rubber bladder. The tank shall have NPT system connections and a .302" - 32" (7.6 – 812mm) charging valve connection (standard tire valve) to facilitate the on-site charging of the tank to meet system requirements. The tank must be constructed in accordance with Section VIII of the ASME Boiler and Pressure Vessel Code.

Maximum Design Pressure: 125psi* (8.6 bar)
 Maximum Design Temperature: 240°F (115°C)
 Precharged to 12psi (83 kPa)

*Models with 200 and 250psi ratings are available.

For additional information, request literature ES-ET-RA.

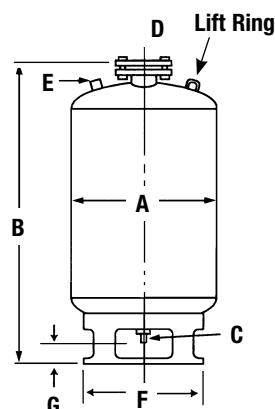

ET-RA 85 – ET-RA 800

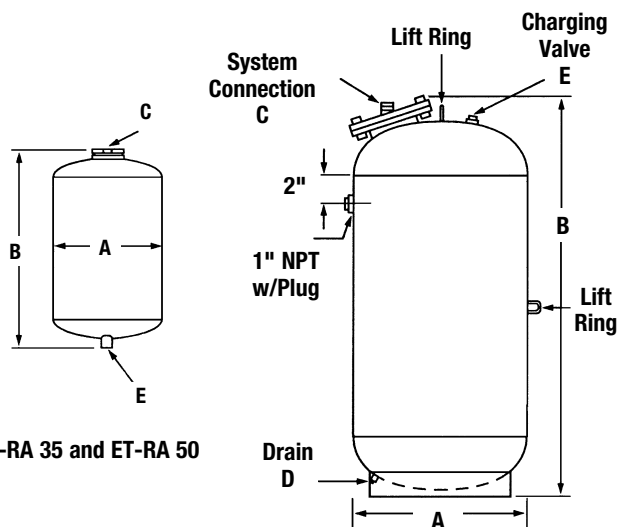

ET-RA 35 and ET-RA 50

ET-RA 1000 – ET-RA 2000

Model	Tank Volume		Tank A (DN)		Dimensions (approx.)										Weight		
	Gals.	Liters	in.	mm	B	C	D	E	F	G	lbs.	kgs.					
ET-RA 35	10	38	12	305	25	635	3/4	19	–	–	.302"	–	–	–	–	40	18
ET-RA 50	13	49.4	14	356	25	635	3/4	19	–	–	–32NC	–	–	–	–	50	23
ET-RA 85	23	87.4	16	400	37	940	1	25	1/2	13	–	12	305	5 1/2	140	90	41
ET-RA 130	35	133	20	508	37	940	1	25	1/2	13	–	16	406	5 1/2	140	125	57
ET-RA 200	53	201.4	24	610	43	1092	1 1/2	38	1/2	13	.302"	20	508	5 1/4	133	210	95
ET-RA 300	79	300	24	610	55	1397	1 1/2	38	3/4	19	–32NC	20	508	5 1/4	133	225	102
ET-RA 400	106	402.8	30	750	49	1245	1 1/2	38	3/4	19	–	24	610	5 1/4	133	300	136
ET-RA 500	132	501.6	30	750	57	1448	1 1/2	38	3/4	19	–	24	610	5 1/4	133	335	152
ET-RA 600	158	600.4	30	750	65	1651	1 1/2	38	3/4	19	–	24	610	5 1/4	133	360	163
ET-RA 800	211	801.8	36	900	63	1600	1 1/2	38	3/4	19	–	30	762	5 1/4	133	475	215
ET-RA 1000	264	1003.2	36	900	74	1880	1 1/2	38	3/4	19	–	–	–	–	–	710	322
ET-RA 1200	317	1204.6	36	900	86	2184	1 1/2	38	3/4	19	–	–	–	–	–	720	327
ET-RA 1400	370	1406	36	900	99	2515	1 1/2	38	3/4	19	.302"	–	–	–	–	875	397
ET-RA 1600	422	1603.6	48	1200	72	1829	1 1/2	38	3/4	19	–32NC	–	–	–	–	1100	499
ET-RA 2000	528	2006.4	48	1200	85	2159	1 1/2	38	3/4	19	–	–	–	–	–	1280	581

Note: Models ET-RA 85 – ET-RA 800 have both top and bottom connections (C and D) to access the bladder.

NOTES



A Watts Water Technologies Company



USA: Tel. (978) 688-1811 • Fax: (978) 794-1848 • www.watts.com
Canada: Tel. (905) 332-4090 • Fax: (905) 332-7068 • www.watts.ca