

IsoTherm Installation

4500 E. Progress Place
Springfield, MO 65803
ph: 417.864.6108
fax: 417.864.8161
www.wattsradiant.com

Product Details

The IsoTherm utilizes both a Mixing Valve and the Law of Tees to control temperature to the zone. Boiler water enters the IsoTherm at point 1 where it passes through the mix valve, mixing with tempered zone water (point 3), and exits at point 2. Water then undergoes another mixing phase before entering the pump at point 5. Discharge water (point 6) is diverted based on flow conditions into the manifold supply and mix valve. Remaining flow is returned to the boiler loop (point 8).

Flow across the manifold (points 7 and 4) is controlled via the individual circuit balancing valves located on the stainless steel manifold. Individual thermal actuators may be used with each circuit for additional control.

The boiler supply temperature must be at least 158°F to obtain the full heat capacity of the 51,000 BTU/hr.

Installation & Operation

The IsoTherm attaches directly to the 1" stainless steel manifold. If using a Watts Radiant manifold box, it may be necessary to rotate the pump head and pump housing, depending on which side the IsoTherm is to mount to the Stainless Steel manifold.

To rotate the pump head, remove the four allen screws located on the pump base. Rotate the head to the desired position and re-attach the allen screws. The pump needs to be installed on its side, as illustrated, to adequately fit inside the box enclosure. Low profile conduit adapters may be required to connect power to the pump.

IsoTherm must be installed using a Primary/Secondary piping format, as shown below. A circulator is provided on the IsoTherm. Field installing an additional/secondary circulator is not required or recommended.

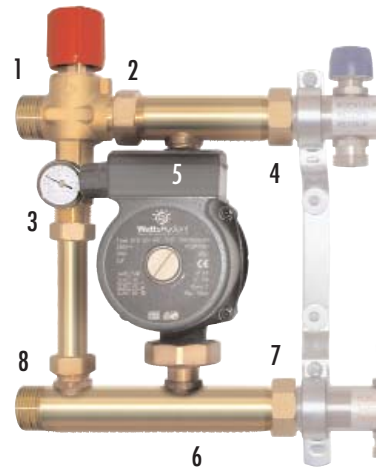

Mix Valve

The mix valve is equipped with a visual indicator pin, designed to indicate mix temperature setting based on pin location. Pilot pin flush with the surface is 131°F. Each click CW (pilot pin rises, temp decreases) or CCW (pilot pin drops, temp increases) is a 3° increase or decrease in temperature.

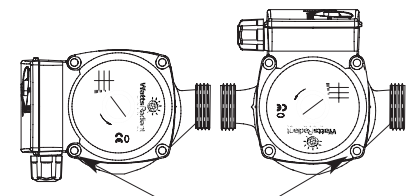
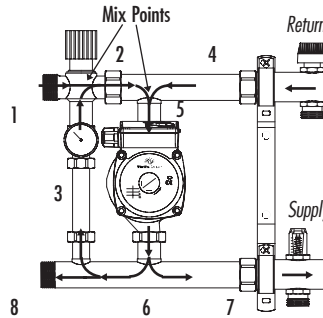
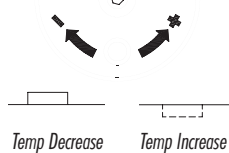

Remove allen screws to rotate pump head. Should only be done if necessary to fit an enclosure.

Primary/Secondary Piping

To ensure proper operation and to prevent any ghost flow conditions, a primary/secondary piping arrangement is required off the main boiler loop with a check valve installed on the supply and return leg to the IsoTherm. Supply/return tees feeding the IsoTherm should be a maximum of 24" apart. A second circulator is not required and is not recommended; the IsoTherm provides its own circulation.

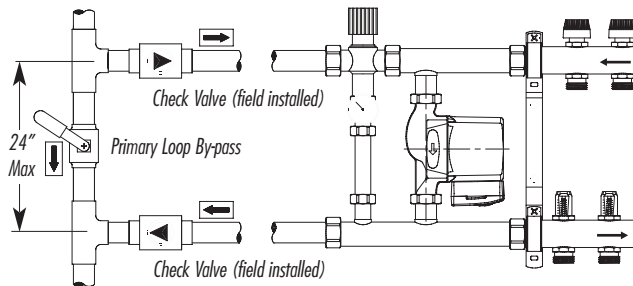

Accessory Items

Accessory items include trunk isolation valves, Stainless to NPT and Stainless to sweat transition fittings.

- Ball Valve with Temperature Gauge
- BSP to 3/4" NPT
- BSP to 1" NPT
- BSP to 1" Sweat

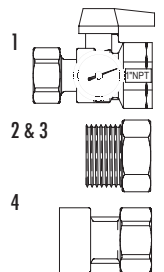

Technical Details

Min. Supply Temperature 113°F
Max. Supply Temperature 140°F
Max. Heat Output 51 MBH

Point	Flow (gpm)	Temp (F)
1	3	180
2	5	132
3	2	120
4	3	100
5	8	120
6	3	120
7	5	120
8	3	120

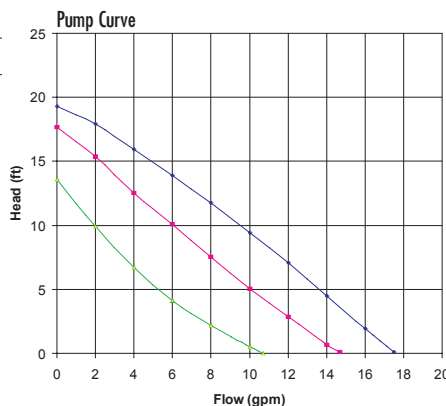

Product Options

Qty.	Description	Part #	Order #
1	IsoTherm, 1" Mixing Module	D3803995	81005361
1	Isolation Ball Valve, Red Handle	D4201720-NR	81001995
1	Isolation Ball Valve, Blue Handle	D4201720-NB	81001994
1	SS Manifold Adapter, 1" NPT	D4201480	81001989
1	SS Manifold Adapter, 1" Sweat	D0505	81005367
1	SS Manifold Adapter, 3/4" Sweat	D0504	81005366

Special Cautions

- Supply temperature from the boiler to the IsoTherm must be at least 158°F for the IsoTherm to operate correctly.
- Install a spring check on both supply and return lines feeding the IsoTherm.
- Supply/return lines must be plumbed no farther than 24" apart off of the primary loop.
- Do not use a secondary circulator to feed the IsoTherm—a circulator is provided with the IsoTherm unit.
- Do not wire the IsoTherm circulator to run continuously.