

Job Name \_\_\_\_\_

Contractor \_\_\_\_\_

Job Location \_\_\_\_\_

Approval \_\_\_\_\_

Engineer \_\_\_\_\_

Contractor's P.O. No. \_\_\_\_\_

Approval \_\_\_\_\_

Representative \_\_\_\_\_

**LEAD FREE\***

## Maxim™ Series M200 (Maxim 200), M200N (Maxim 200N)

### Double Check Valve Assemblies Sizes: 2½" – 10"

The Maxim M200, M200N Double Check Valve Assemblies are used to prevent backflow of pollutants, that are objectionable but not toxic, from entering the potable water supply system. The Maxim M200, M200N may be installed under continuous pressure service and may be subjected to backpressure. The Maxim M200, M200N consists of two independently operating check valves, two shutoff valves, and four test cocks. For use in non-health hazard applications.

#### Features

- Extremely Compact Design
- 70% Lighter than Traditional Designs
- 304 (Schedule 40) Stainless Steel Housing & Sleeve
- Groove Fittings Allow Integral Pipeline Adjustment
- Patented Tri-Link Checks Provides Lowest Pressure Loss
- Unmatched Ease of Serviceability
- Available with Grooved Butterfly Valve Shutoffs
- Available for Horizontal, Vertical or N Pattern Installations
- Replaceable Check Disc Rubber

#### Specifications

The Double Check Valve Assemblies shall consist of two independent Tri-Link Check modules within a single housing, sleeve access port, four test cocks and two drip tight shutoff valves. Tri-Link Checks shall be removable and serviceable, without the use of special tools. The housing shall be constructed of 304 (Schedule 40) stainless steel pipe with groove end connections. Tri-Link Checks shall have reversible elastomer discs and in operation shall produce drip tight closure against the reverse flow of liquid caused by backpressure or backsiphonage. Assembly shall be a Maxim M200, M200N as manufactured by the Ames Fire & Waterworks.

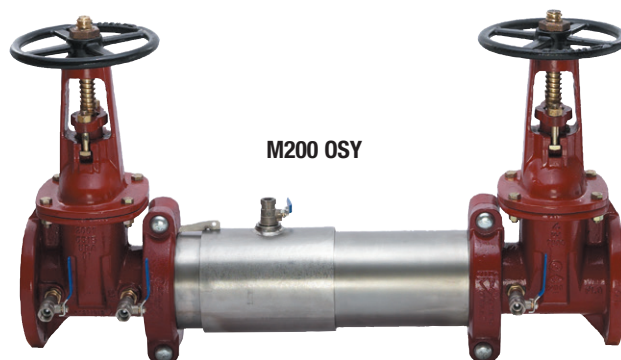

M200 OSY



M200 BFG

#### NOTICE

The information contained herein is not intended to replace the full product installation and safety information available or the experience of a trained product installer. You are required to thoroughly read all installation instructions and product safety information before beginning the installation of this product.

\*The wetted surface of this product contacted by consumable water contains less than 0.25% of lead by weight.

Ames Fire & Waterworks product specifications in U.S. customary units and metric are approximate and are provided for reference only. For precise measurements, please contact Ames Fire & Waterworks Technical Service. Ames Fire & Waterworks reserves the right to change or modify product design, construction, specifications, or materials without prior notice and without incurring any obligation to make such changes and modifications on Ames Fire & Waterworks products previously or subsequently sold.



**AMES**  
FIRE & WATERWORKS  
A WATTS Brand

## Configurations

- Horizontal
- Vertical up
- “N” pattern horizontal

## Materials

- Housing & Sleeve: 304 (Schedule 40) Stainless Steel
- Elastomers: EPDM, Silicone and Buna ‘N’
- Tri-Link Checks: Noryl®, Stainless Steel
- Check Discs: Reversible Silicone or EPDM
- Test Cocks: Bronze Body Nickel Plated
- Pins & Fasteners: 300 Series Stainless Steel
- Springs: Stainless Steel

## Available Models

OSY — UL/FM outside stem and yoke resilient seated gate valves  
 BFG — UL/FM grooved gear operated butterfly valves w/  
 tamper switch

NRS — non-rising stem resilient seated gate valves

\*OSY FxG — Flanged inlet gate connection and grooved  
 outlet gate connection

\*OSY GxF — Grooved inlet gate connection and flanged  
 outlet gate connection

\*OSY GxG — Grooved inlet gate connection and grooved  
 outlet gate connection

Available with grooved NRS gate valves — consult factory\*  
 Post indicator plate and operating nut available — consult factory\*

\*Consult factory for dimensions

## Pressure — Temperature

Temperature Range: 33°F – 110°F (0.5°C – 43°C)

Maximum Working Pressure: 175 psi (12.06 bar)

## Dimensions — Weights

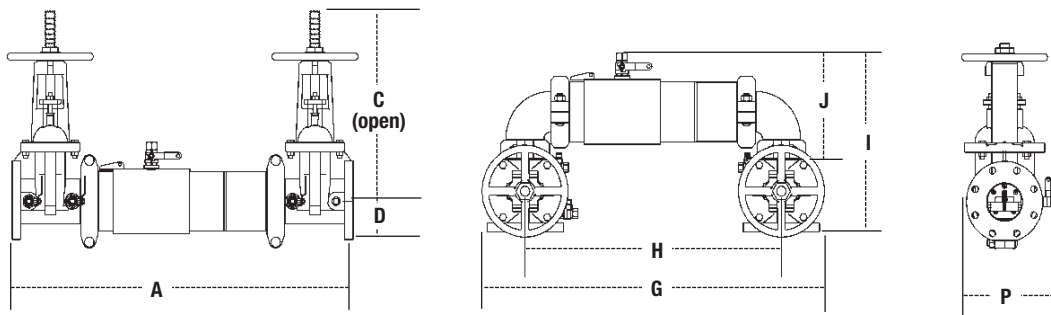

### M200, M200N

SIZE	DIMENSIONS														WEIGHT											
	A		C (OSY)		C (NRS)		D		G		H		I		J		P		M200				M200N			
	in	mm	in	mm	in	mm	in	mm	in	mm	in	mm	in	mm	in	mm	in	mm	lbs.	kgs.	lbs.	kgs.	lbs.	kgs.	lbs.	kgs.
2½	30¾	781	16¾	416	9¾	238	3½	89	29½	738	21½	546	15½	402	8½	223	9½	234	125	57	115	52	133	60	122	55
3	31¾	806	18¾	479	10¼	260	3½	94	30½	775	22¼	565	17¾	435	9¾	233	10½	267	145	66	131	59	158	72	144	65
4	40½	1029	22¾	578	12¾	310	5	127	39¾	1010	30¼	768	20¾	518	11½	297	11¾	284	225	102	219	99	248	113	242	110
6	47¾	1213	30¾	765	16	406	6½	165	40	1016	37½	953	24¾	629	14¾	360	15½	394	390	177	368	167	430	195	408	185
8	54¾	1391	37¾	959	19½	506	7½	191	59¾	1502	45½	1146	28¾	721	16¾	425	17½	445	564	256	522	237	640	290	598	271
10	57¾	1467	45¾	1162	23¾	616	8¾	208	66	1676	49½	1257	32½	826	17¾	440	20	508	781	354	721	327	951	431	890	404

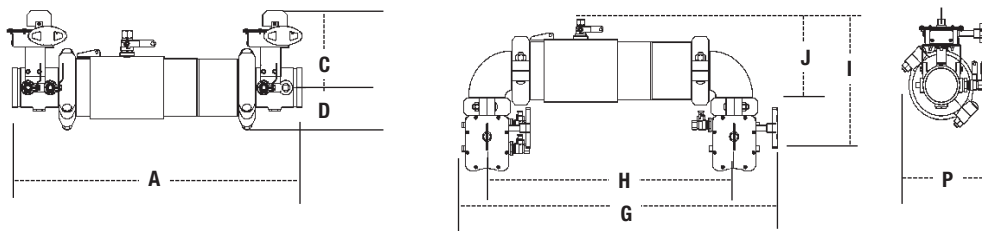

### M200BFG, M200NBFG

SIZE	DIMENSIONS										WEIGHT									
	A		C		D		G		H		I		J		P		M200BFG		M200NBFG	
	in.	mm	in.	mm	in.	mm	in.	mm	in.	mm	in.	mm	in.	mm	in.	mm	lbs.	kgs.	lbs.	kgs.
2½	27¾	705	8	203	3½	89	29¾	759	21½	546	14½	379	8½	223	9	229	56	25	64	29
3	28¼	718	8½	211	3½	94	30¾	781	22¼	565	15½	392	9¾	233	9½	241	54	24	67	30
4	35¾	908	8½	221	4½	122	39	991	30¼	768	18	457	11½	297	11	279	119	54	142	64
6	40¾	1035	10	254	6	152	47½	1205	37½	953	20½	525	14¾	360	15½	394	211	96	251	114
8	47¾	1213	12¾	310	6½	173	56	1422	45½	1146	24¾	613	16¾	425	17½	445	345	156	421	191

Noryl® is a registered trademark of SABIC Innovative Plastics™.

## Approvals

- Approved by the Foundation for Cross-Connection Control and Hydraulic Research at The University of Southern California (FCCCHR-USC)
- AWWA C510-97

For additional approval information please contact the factory or visit our website at [www.amesfirewater.com](http://www.amesfirewater.com)



\_\_\_\_\_ Horizontal    \_\_\_\_\_ Vertical    - - - - - N - Pattern

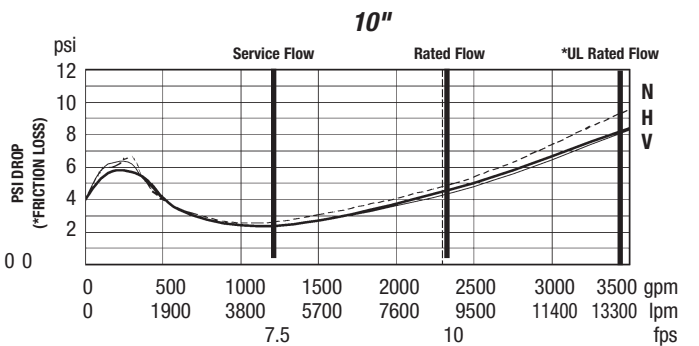
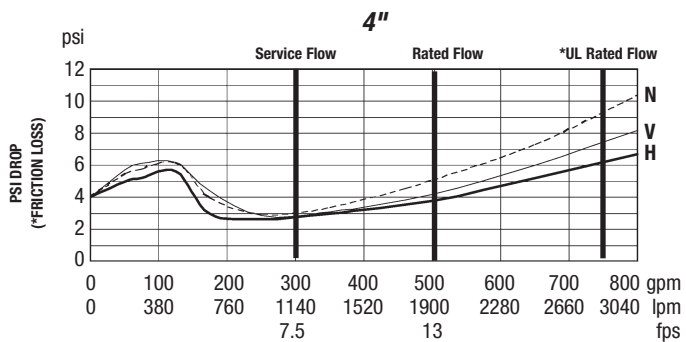
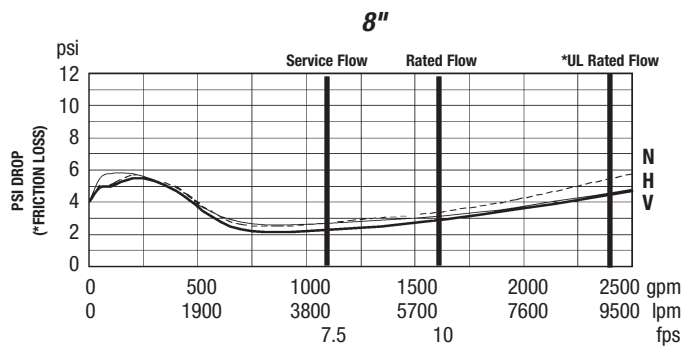
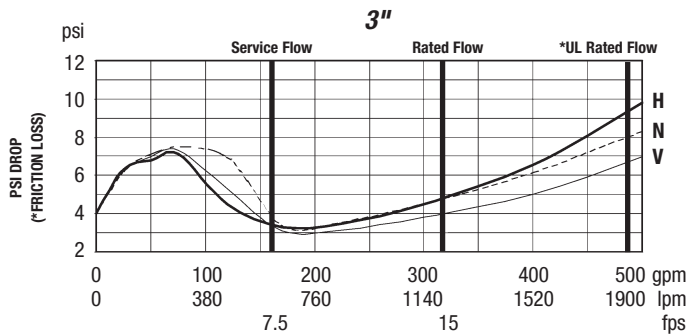
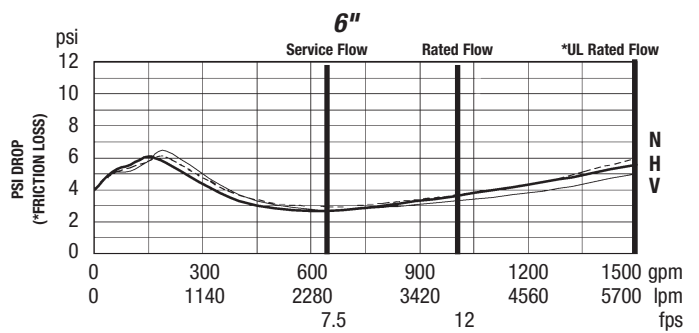
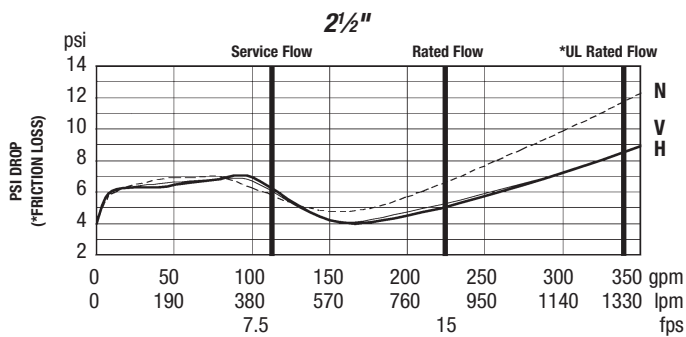

## Capacity

UL/FM Certified Flow Characteristics

Flow characteristics collected using butterfly shutoff valves.

### Flow capacity chart identifies valve performance based upon rated water velocity up to 25fps

- Service Flow is typically determined by a rated velocity of 7.5fps based upon schedule 40 pipe.
- Rated Flow identifies maximum continuous duty performance determined by AWWA.
- UL Flow Rate is 150% of Rated Flow and is not recommended for continuous duty.
- AWWA Manual M22 [Appendix C] recommends that the maximum water velocity in services be not more than 10fps.

### NOTICE

Inquire with governing authorities for local installation requirements

For additional information, visit our web site at: [www.amesfirewater.com](http://www.amesfirewater.com)



**A WATTS Brand**

---

**USA: Backflow** Tel: (978) 689-6066 • Fax: (978) 975-8350 • [AmesFireWater.com](http://AmesFireWater.com)  
**USA: Control Valves** Tel: (713) 943-0688 • Fax: (713) 944-9445 • [AmesFireWater.com](http://AmesFireWater.com)  
**Canada:** Tel: (905) 332-4090 • Fax: (905) 332-7068 • [AmesFireWater.ca](http://AmesFireWater.ca)  
**Latin America:** Tel: (52) 81-1001-8600 • [AmesFireWater.com](http://AmesFireWater.com)